

# BLOCK A

## TYPE A-1E

1 Bedroom  
+ 2 Bathroom  
53 sq m / 570 sq ft

#01-14

Inclusive of PES, AC Ledge

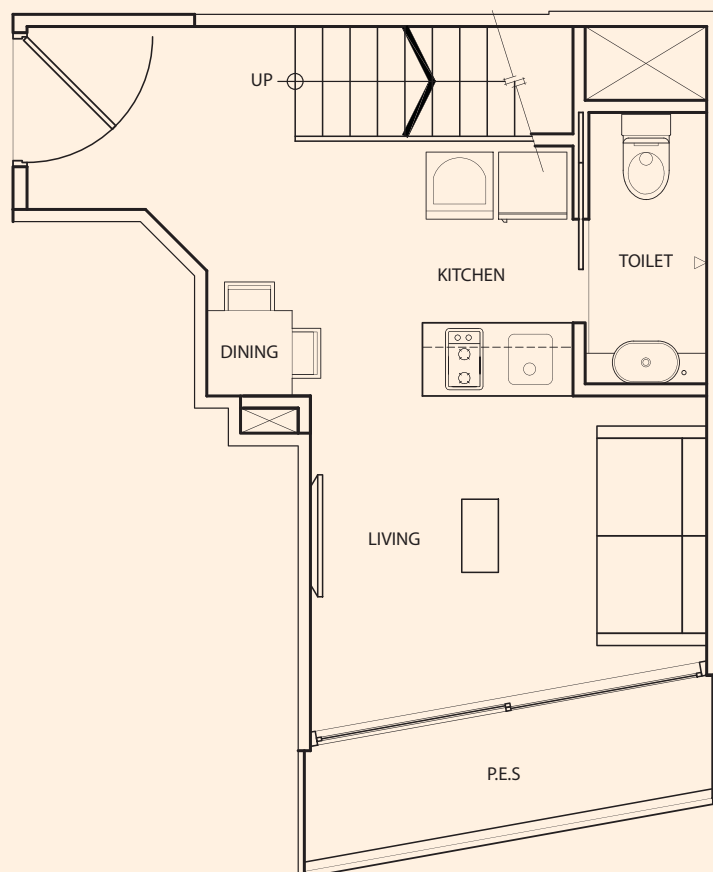

lower floor

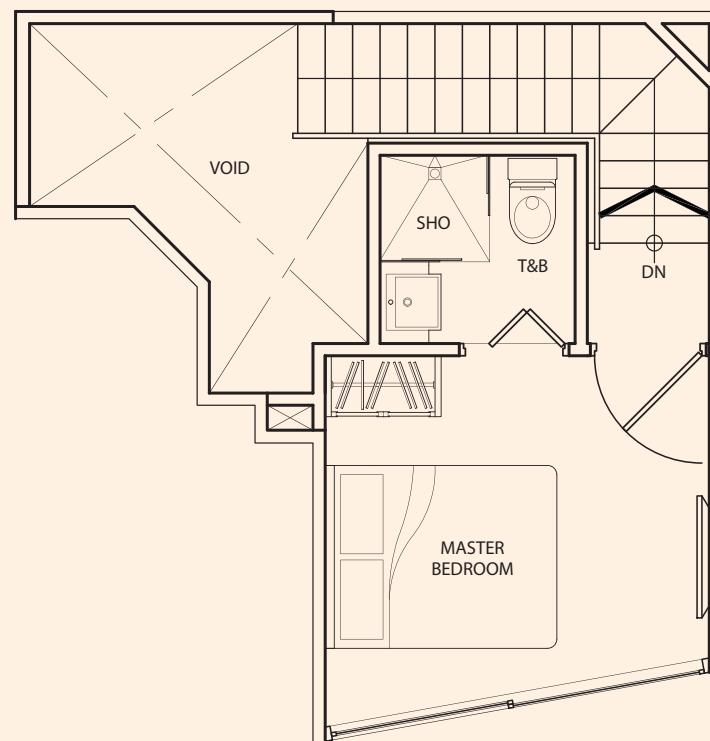

upper floor

## TYPE A-1F

1 Bedroom  
+ 2 Bathroom  
66 sq m / 710 sq ft

#01-15

Inclusive of Balcony,  
PES, AC Ledge

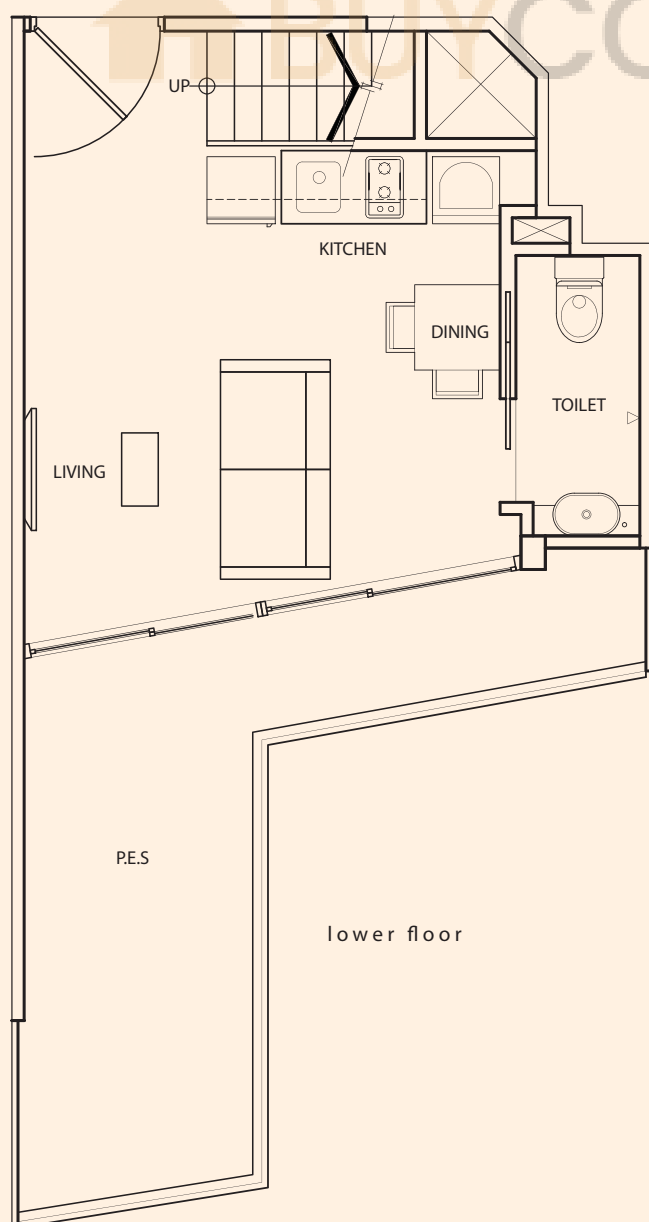

lower floor

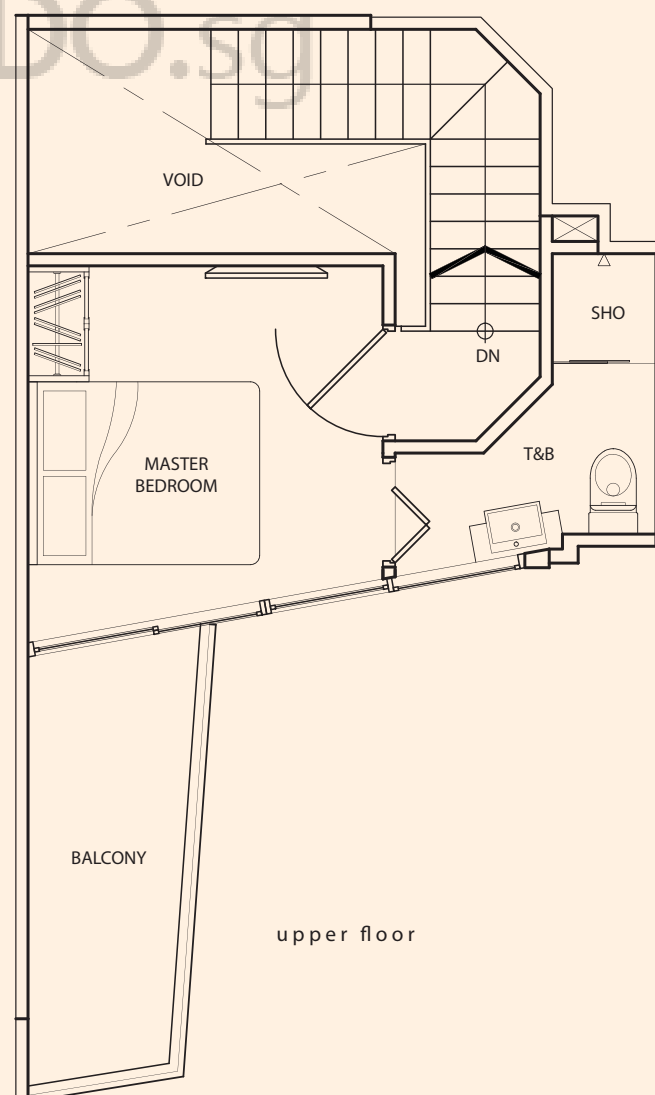

upper floor

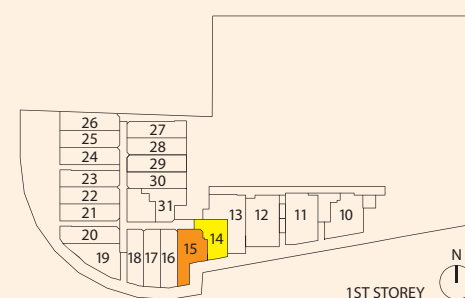

TYPE **A-1G**

1 Bedroom  
+ 2 Bathroom  
55 sq m / 592 sq ft

#01-16

Inclusive of Balcony, PES,  
AC Ledge



lower floor

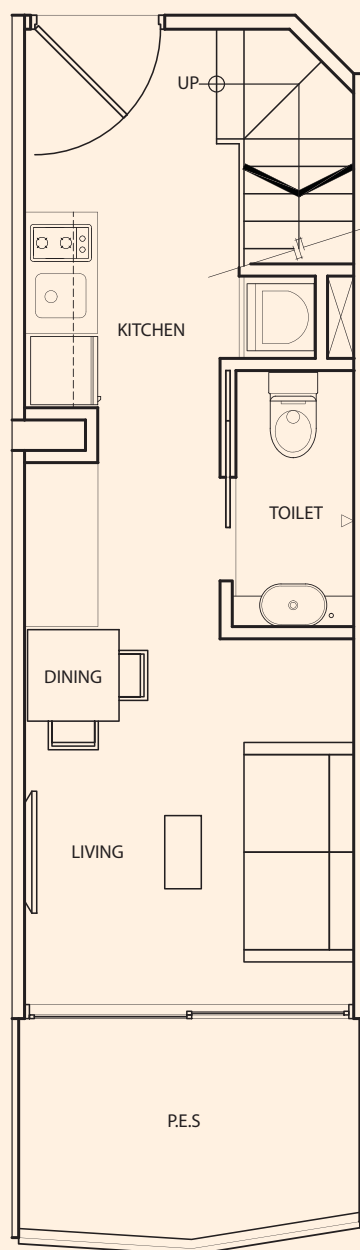

upper floor

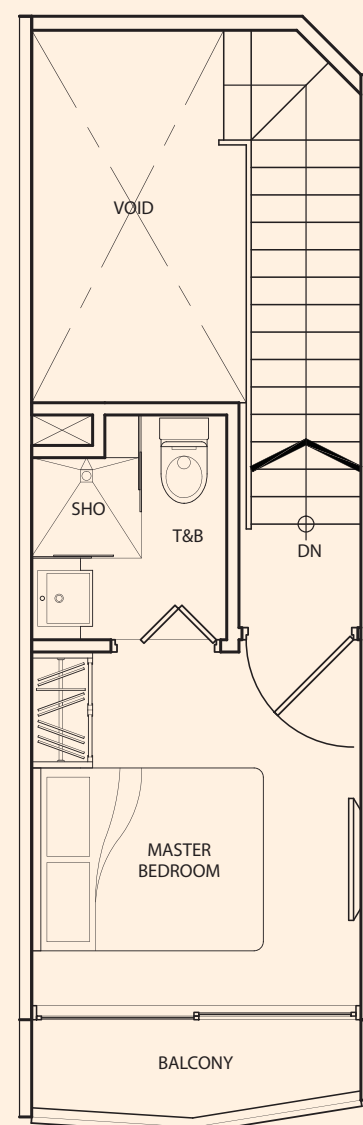

TYPE **A-1H**

1 Bedroom  
+ 2 Bathroom  
55 sq m / 592 sq ft

#01-17

Inclusive of Balcony, PES,  
AC Ledge



lower floor

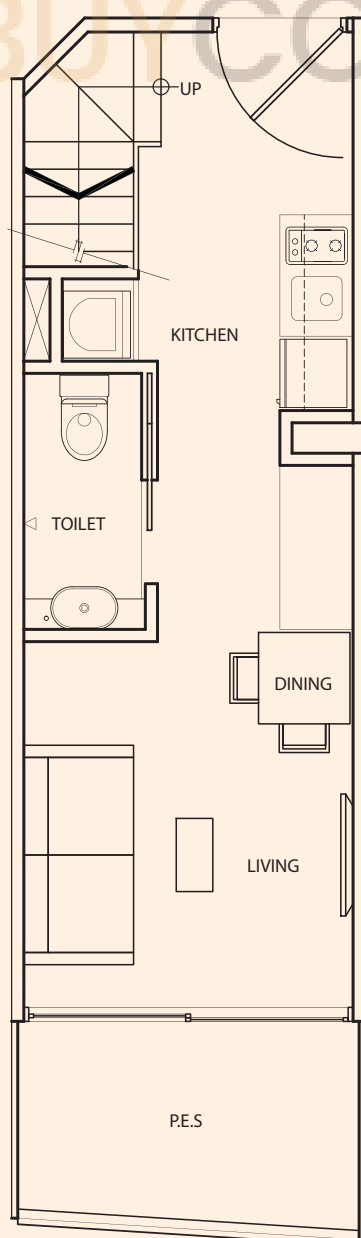

upper floor

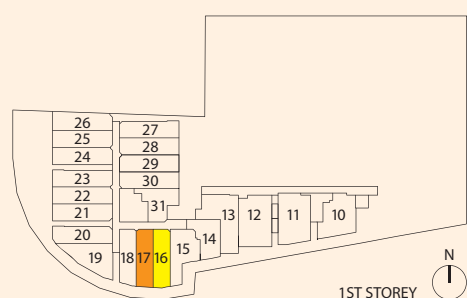
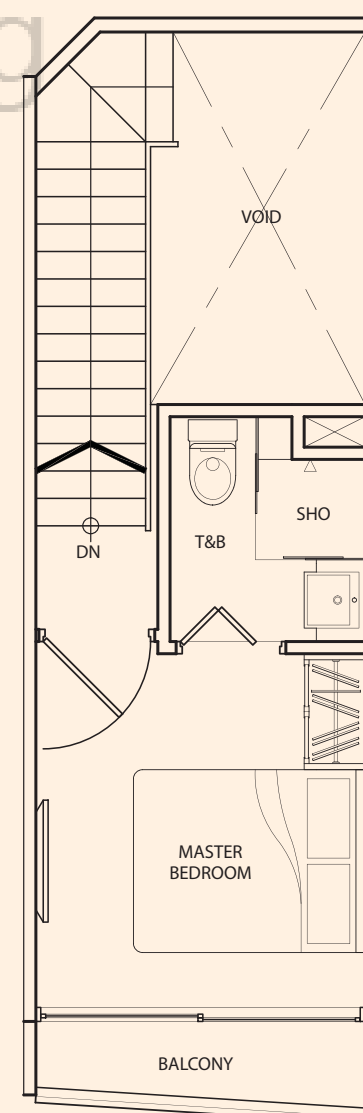

TYPE A-1I

1 Bedroom  
+ 2 Bathroom  
53 sq m / 570 sq ft

#01-18

Inclusive of Balcony,  
PES, AC Ledge



lower floor

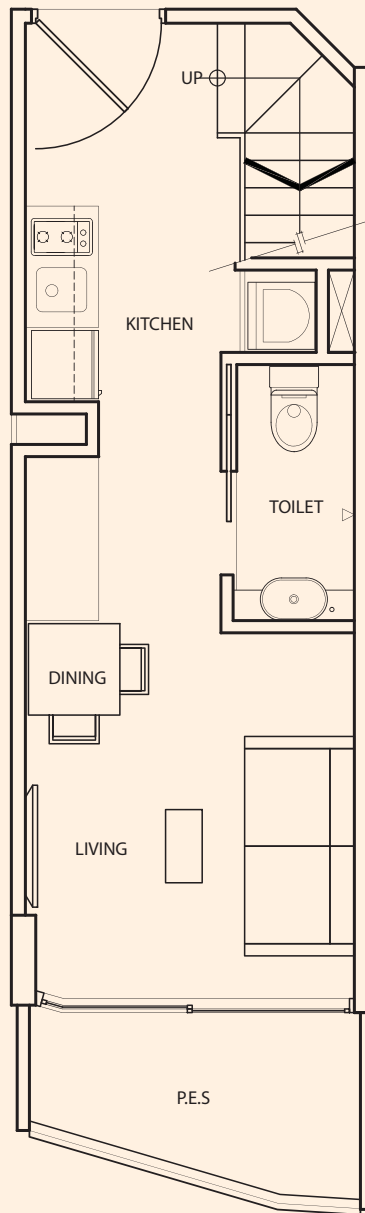

upper floor

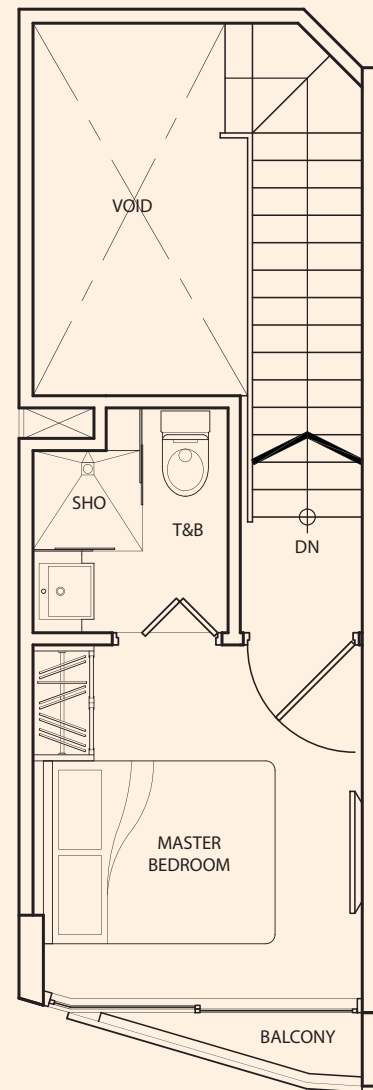

TYPE A-1J

1 Bedroom  
+ 2 Bathroom  
60 sq m / 646 sq ft

#01-19

Inclusive of Balcony, PES,  
AC Ledge

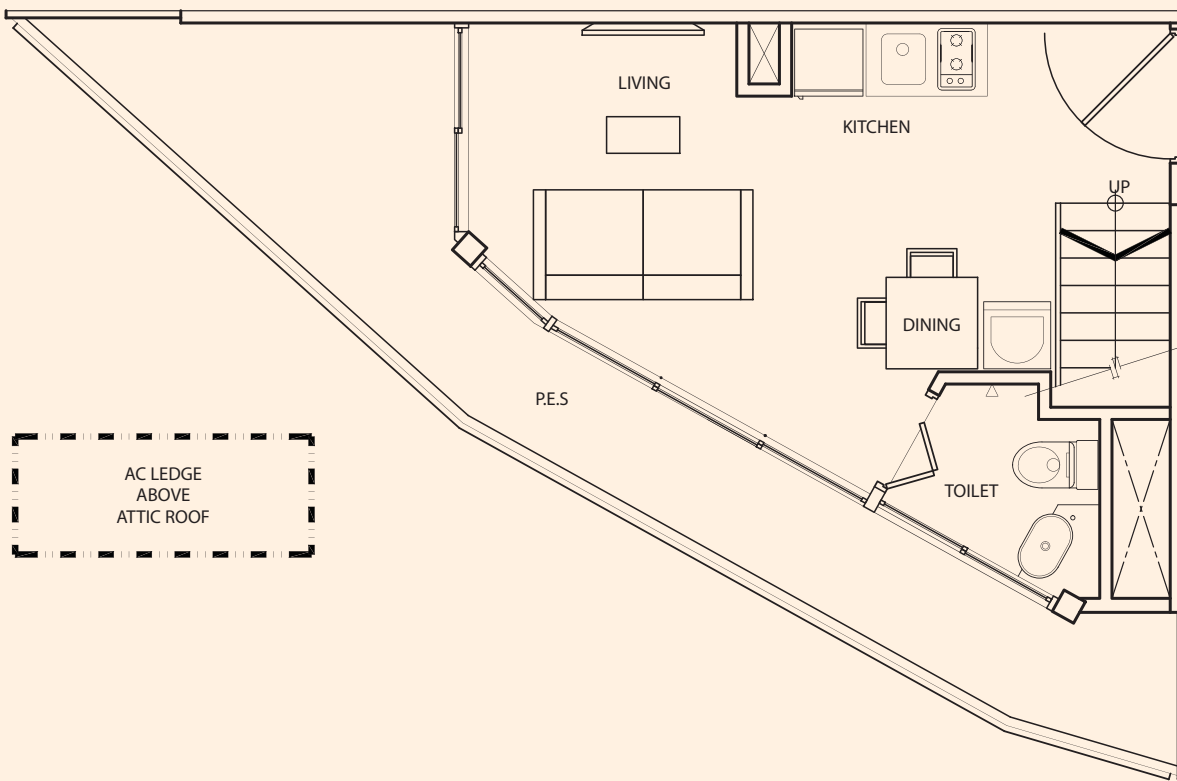

lower floor

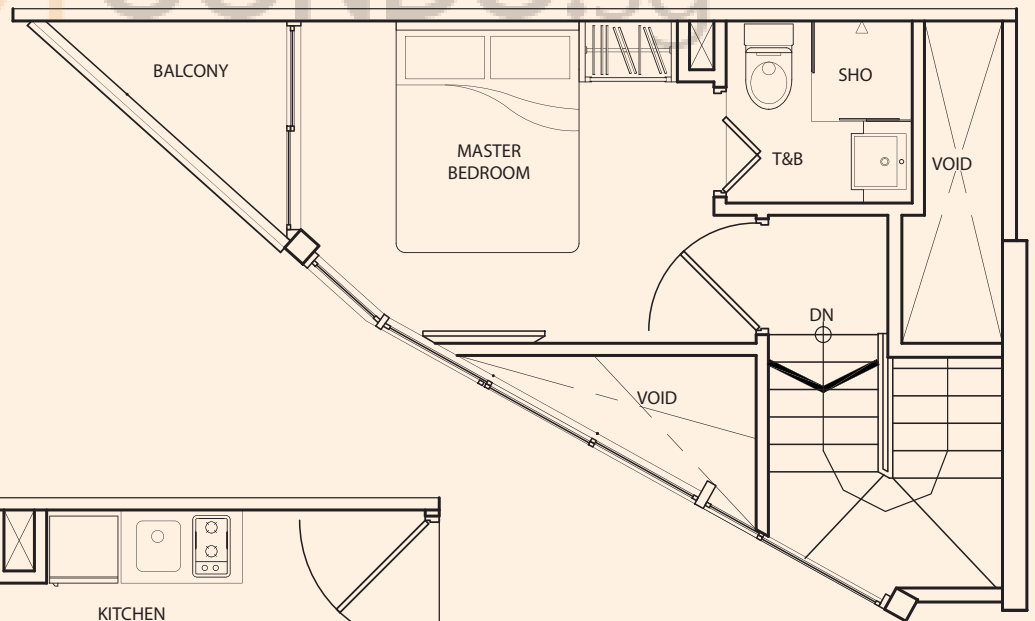

upper floor

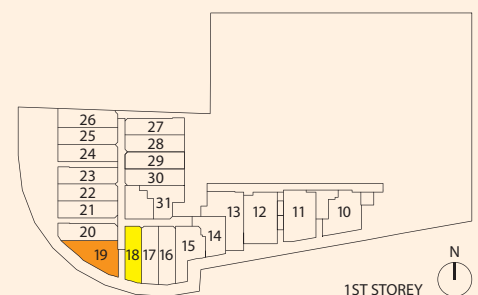

TYPE A-1K

1 Bedroom  
+ 2 Bathroom  
57 sq m / 613 sq ft

#01-20

Inclusive of Balcony, PES,  
AC Ledge

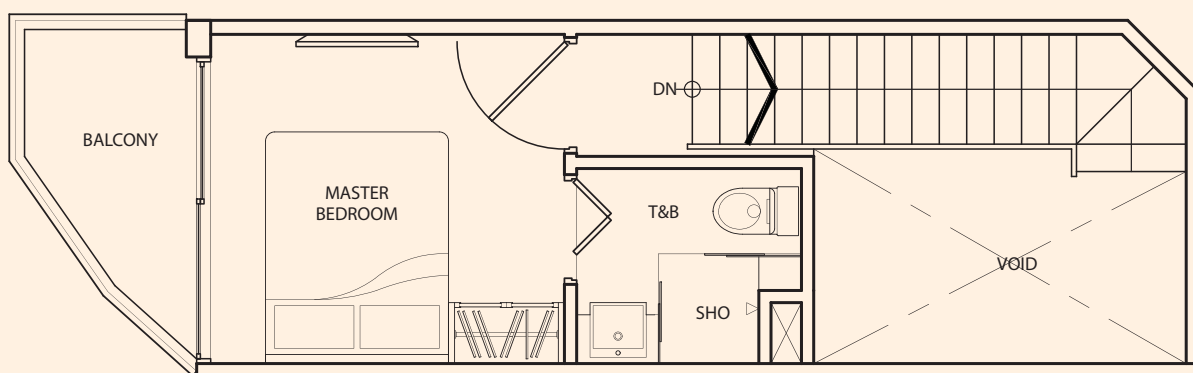

upper floor

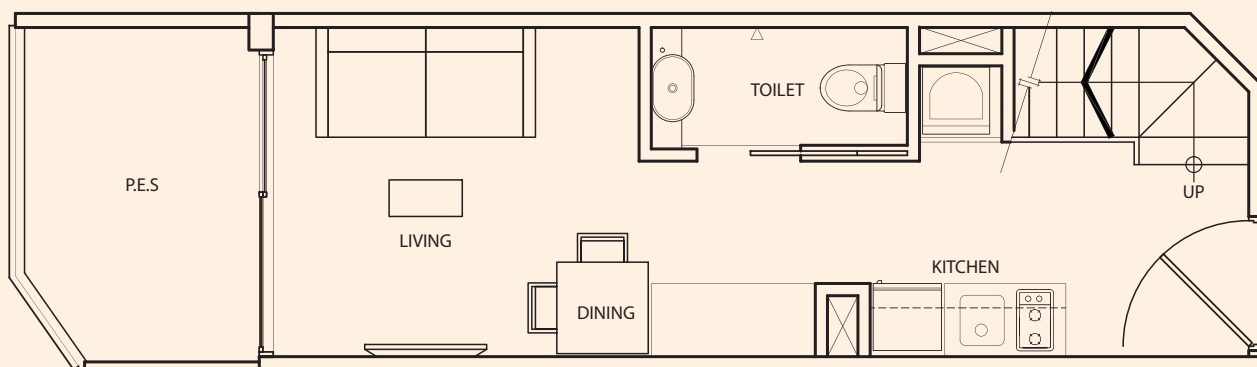

lower floor



TYPE A-1L

1 Bedroom  
+ 2 Bathroom  
59 sq m / 635 sq ft

#01-21

#01-23

#01-24

Inclusive of Balcony, PES,  
AC Ledge

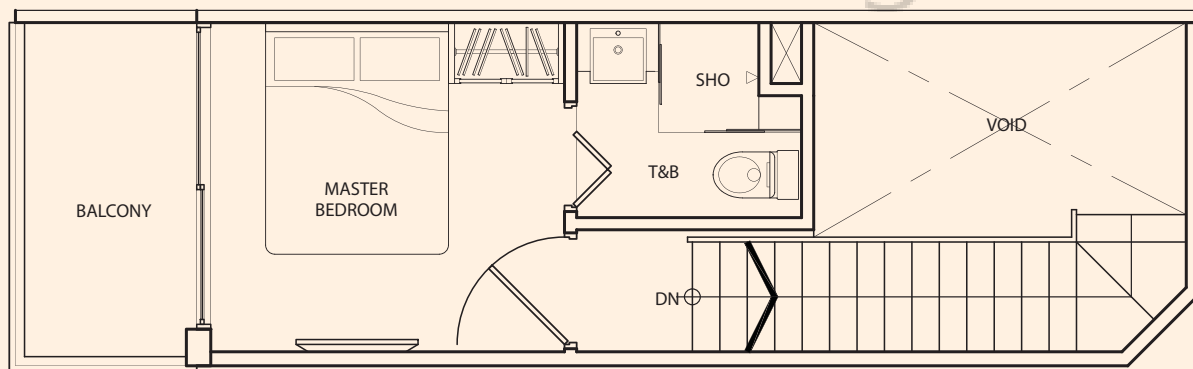

upper floor

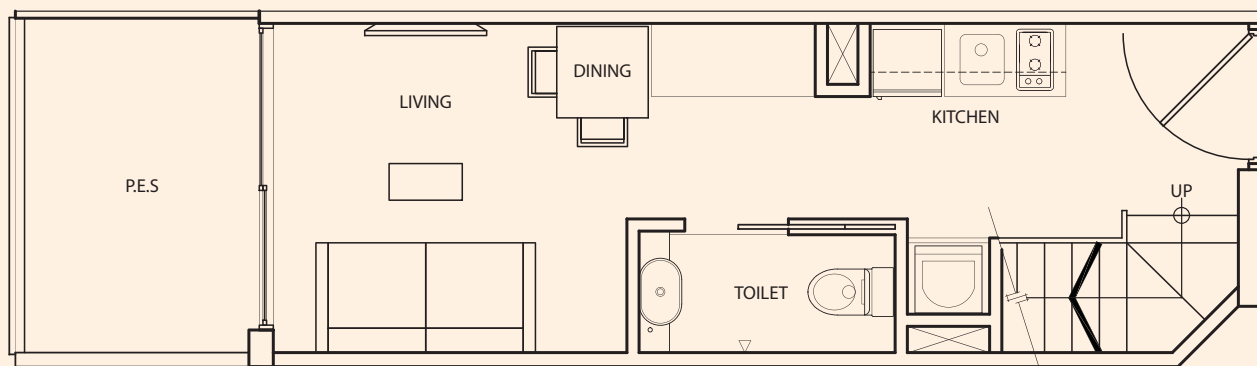

lower floor

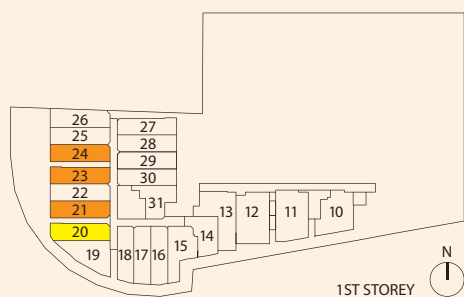

TYPE **A-1M**

1 Bedroom  
+ 2 Bathroom  
59 sq m / 635 sq ft

#01-22

Inclusive of Balcony, PES,  
AC Ledge

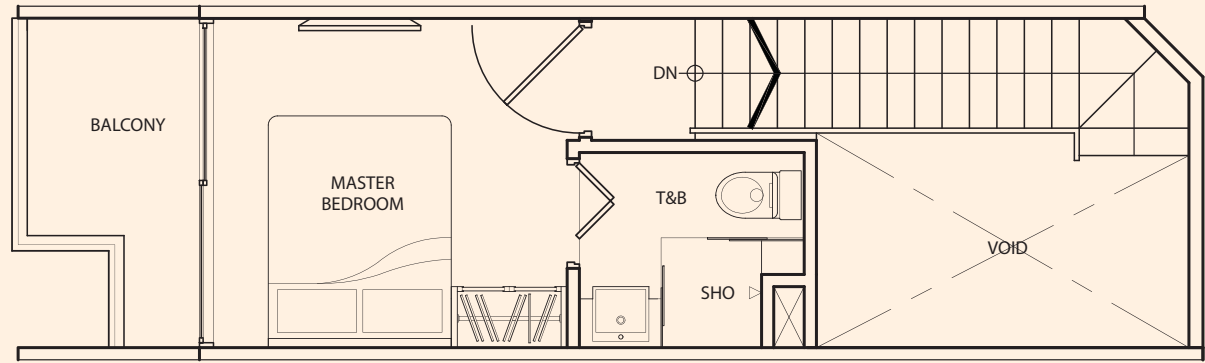

upper floor

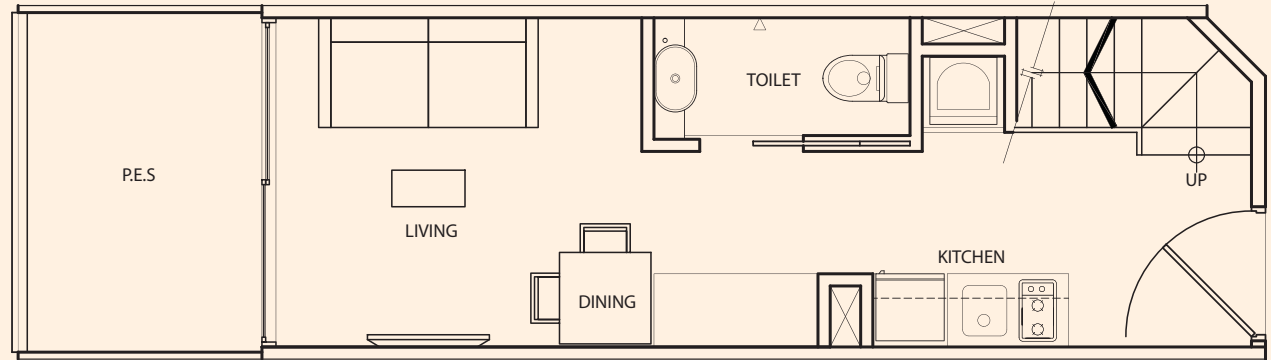

lower floor



TYPE **A-1N**

1 Bedroom  
+ 2 Bathroom  
59 sq m / 635 sq ft

#01-25

Inclusive of Balcony, PES,  
AC Ledge

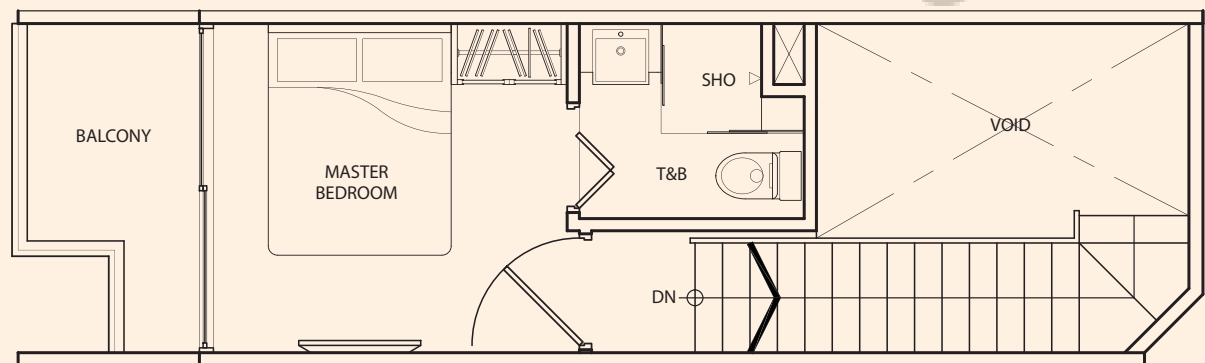

upper floor

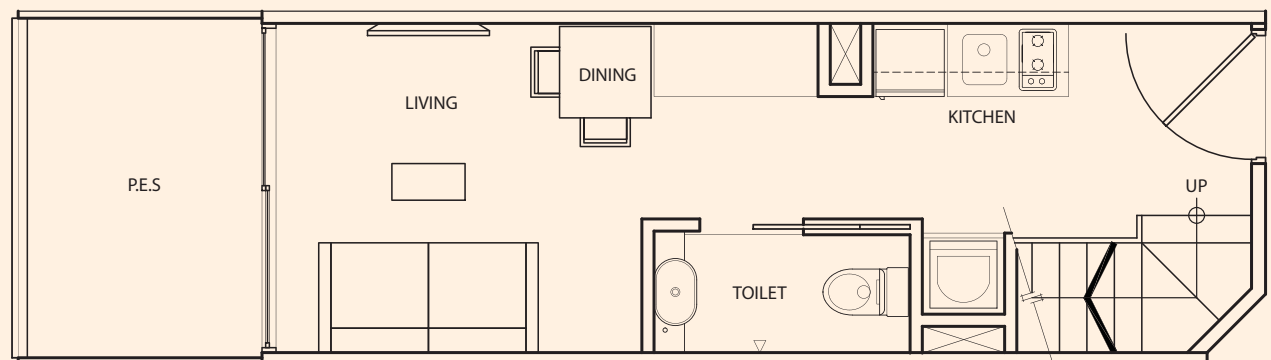

lower floor

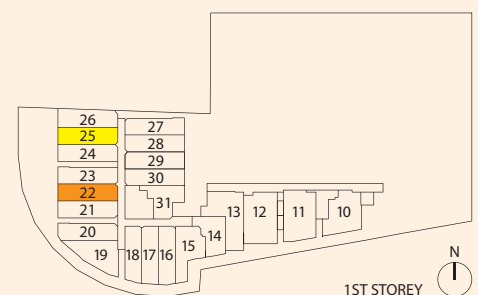

TYPE A-10

1 Bedroom  
+ 2 Bathroom  
61 sq m / 657 sq ft

#01-26

Inclusive of Balcony, PES,  
AC Ledge

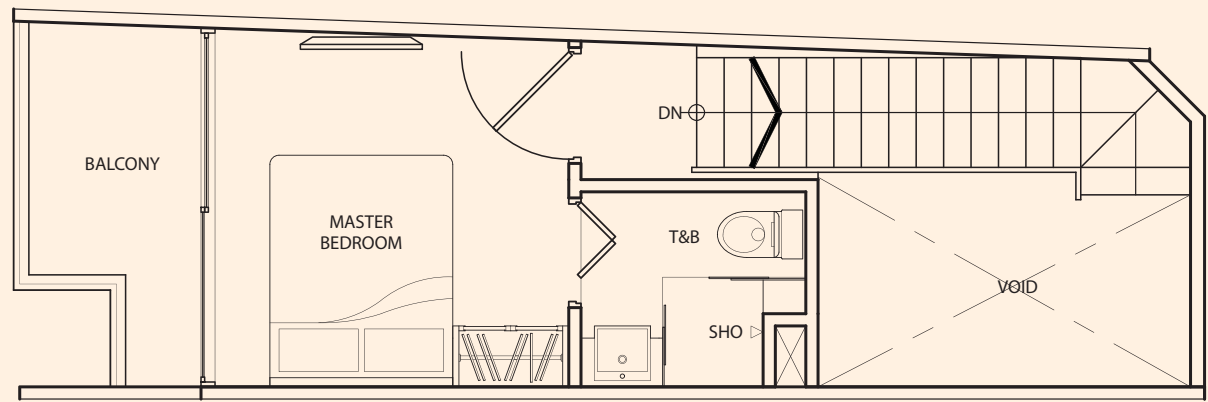

upper floor

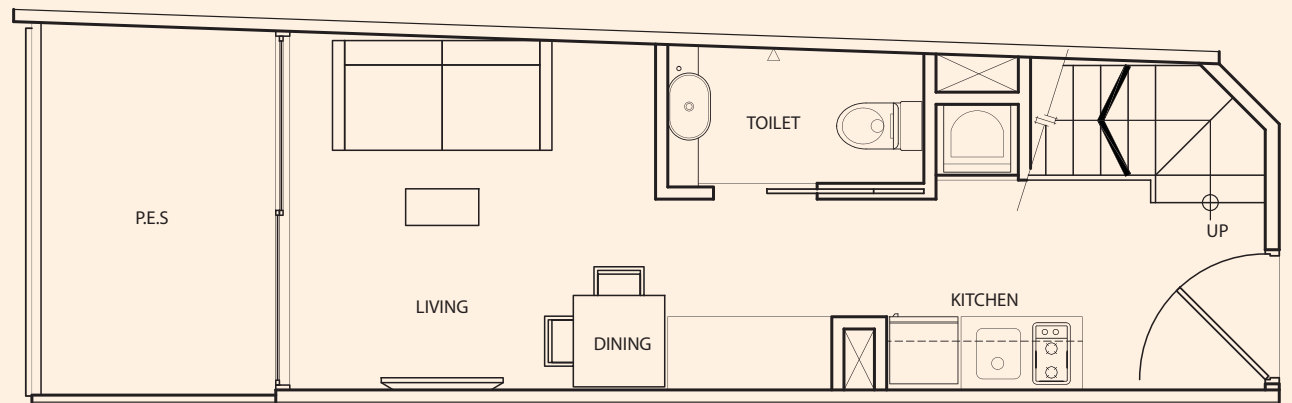

lower floor



TYPE A-1P

1 Bedroom  
+ 2 Bathroom  
59 sq m / 635 sq ft

#01-27

Inclusive of Balcony, PES,  
AC Ledge

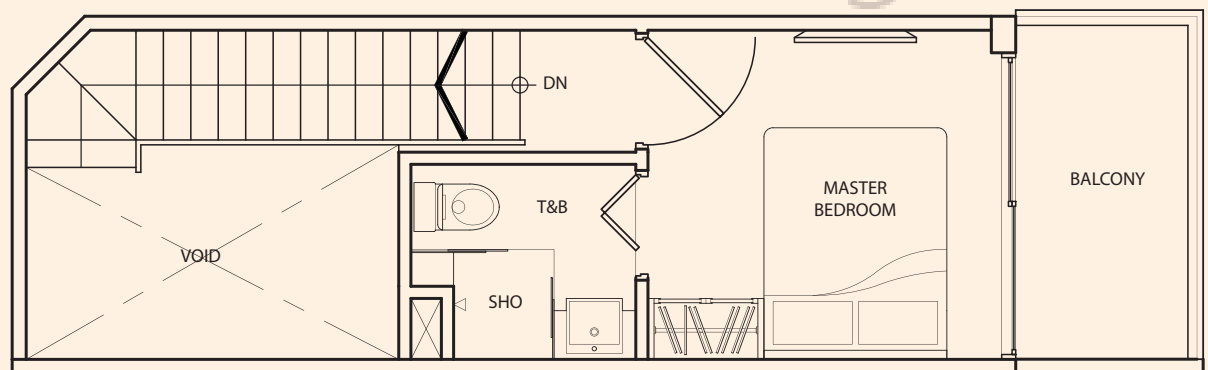

upper floor

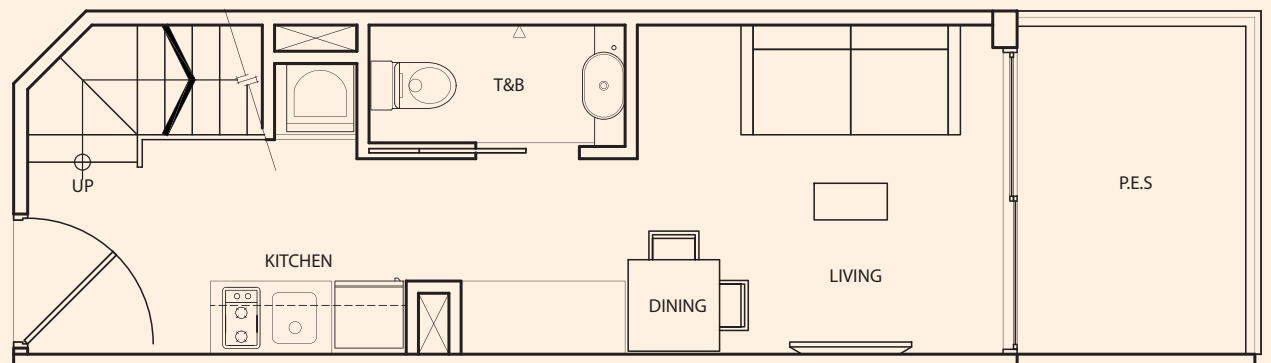

lower floor

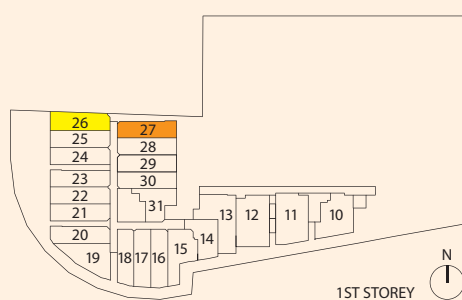

TYPE **A-1Q**

1 Bedroom  
+ 2 Bathroom  
59 sq m / 635 sq ft

#01-28  
#01-30

Inclusive of Balcony, PES,  
AC Ledge

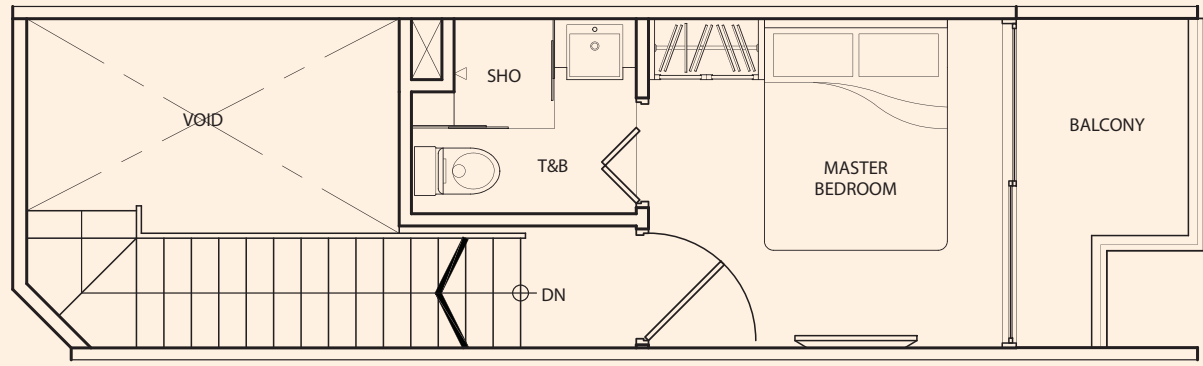

upper floor

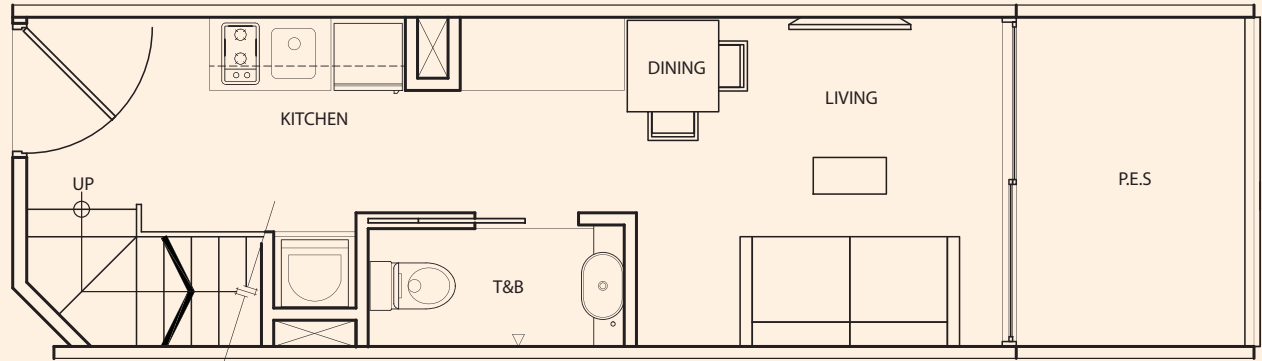

lower floor



TYPE **A-1R**

1 Bedroom  
+ 2 Bathroom  
59 sq m / 635 sq ft

#01-29

Inclusive of Balcony, PES,  
AC Ledge

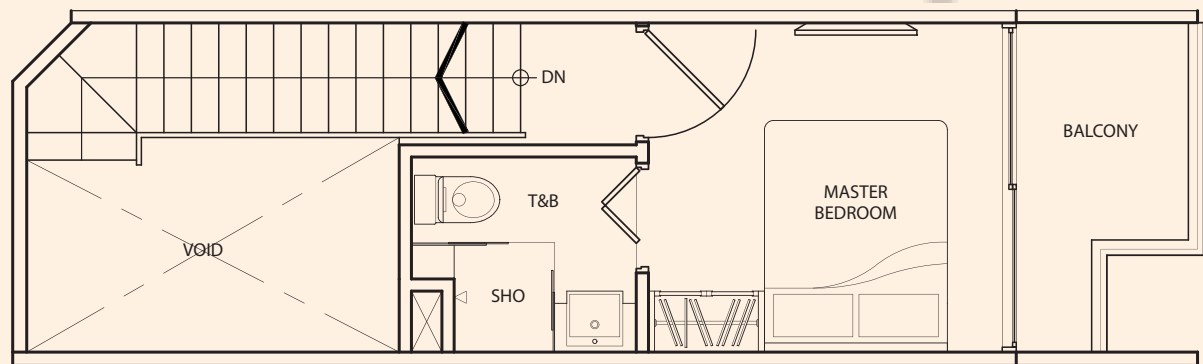

upper floor

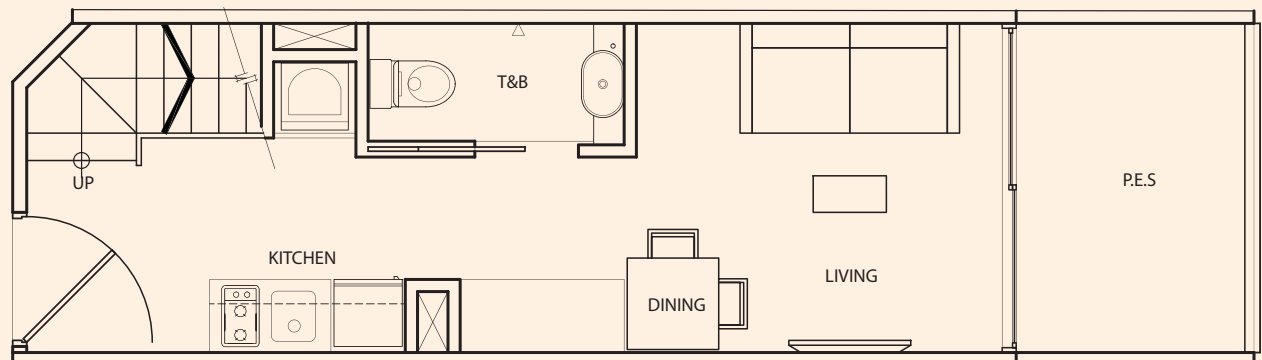

lower floor

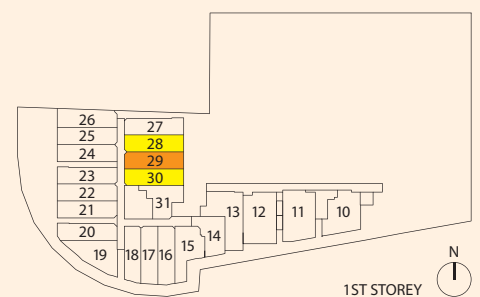

TYPE A-1S

1 Bedroom  
+ 2 Bathroom  
56 sq m / 603 sq ft

#01-31

Inclusive of Balcony, PES,  
AC Ledge

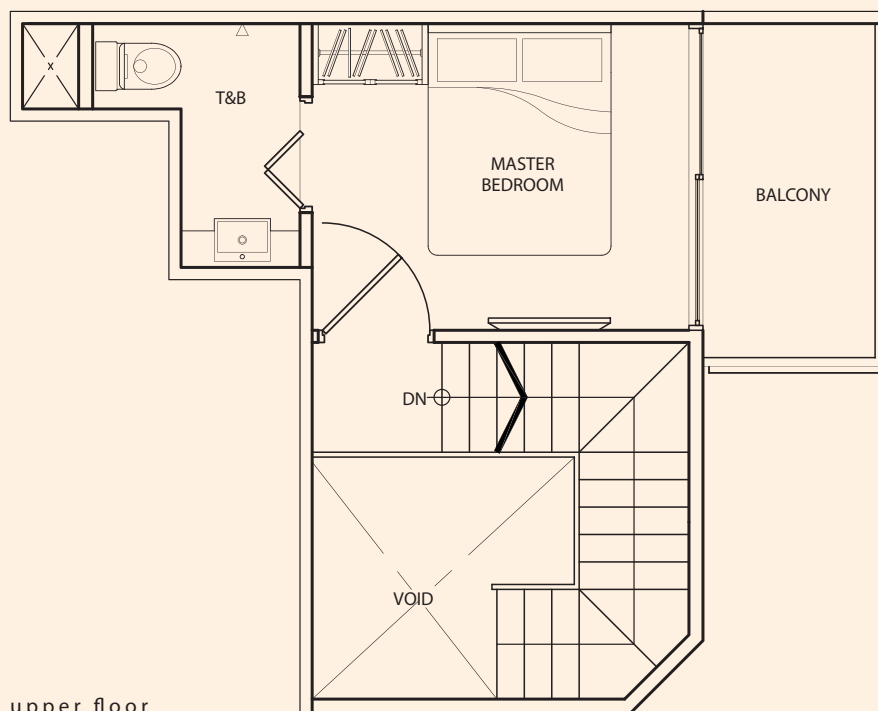

upper floor

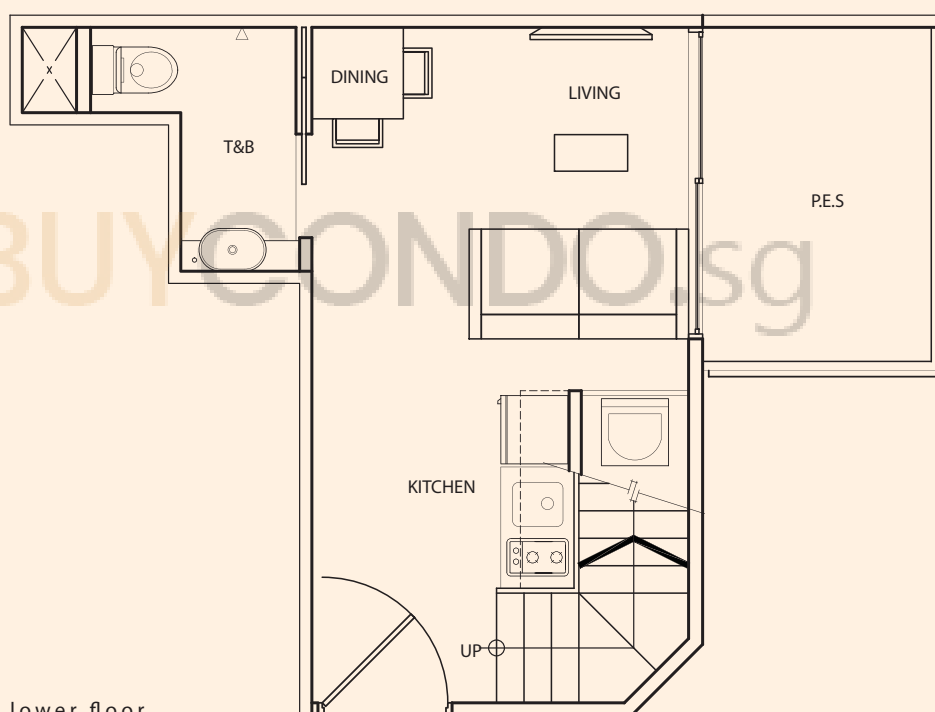

lower floor

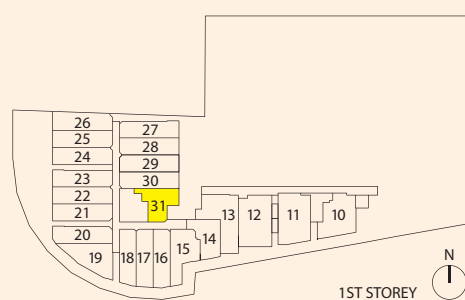



TYPE **A-3E**

1 Bedroom  
+ 2 Bathroom  
50 sq m / 538 sq ft

#03-14

Inclusive of AC Ledge

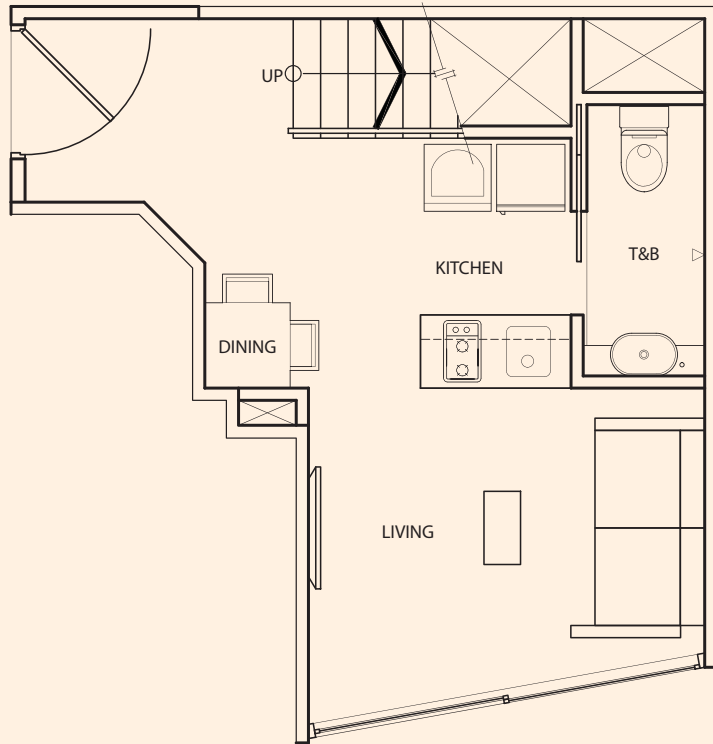

lower floor

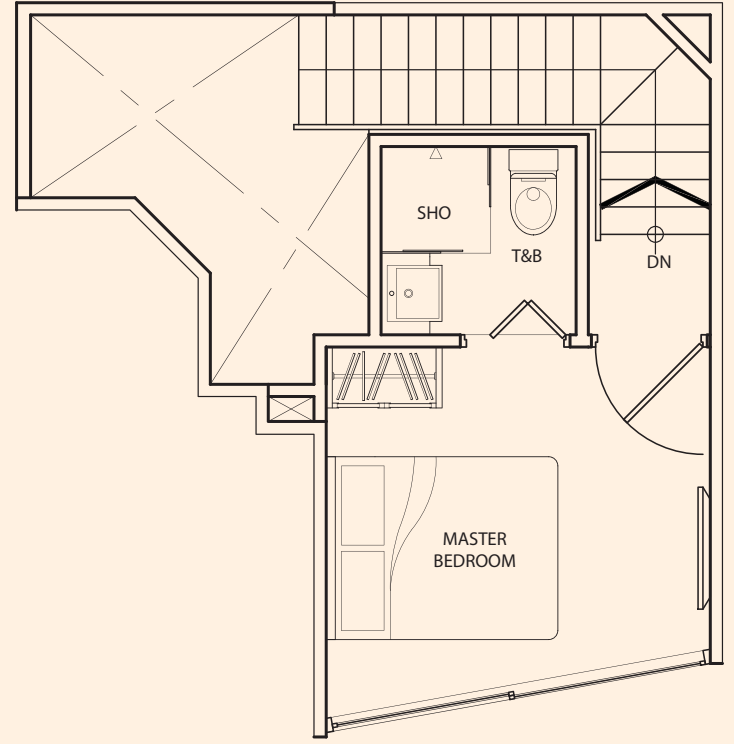

upper floor

TYPE **A-3F**

1 Bedroom  
+ 2 Bathroom  
58 sq m / 624 sq ft

#03-15

Inclusive of Balcony, AC Ledge

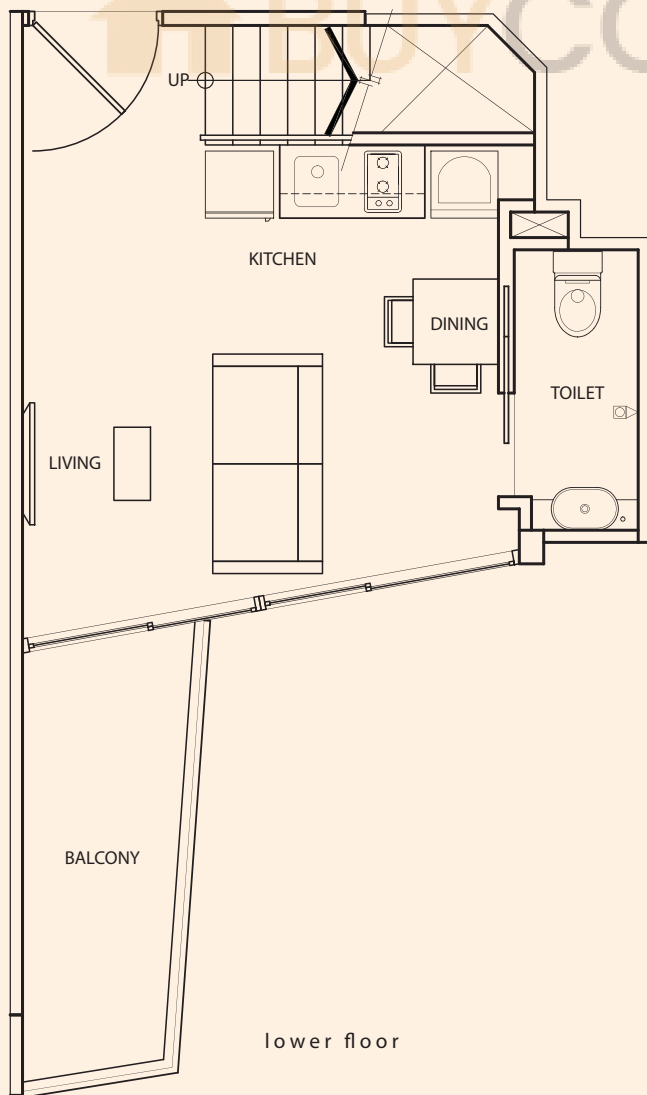

lower floor

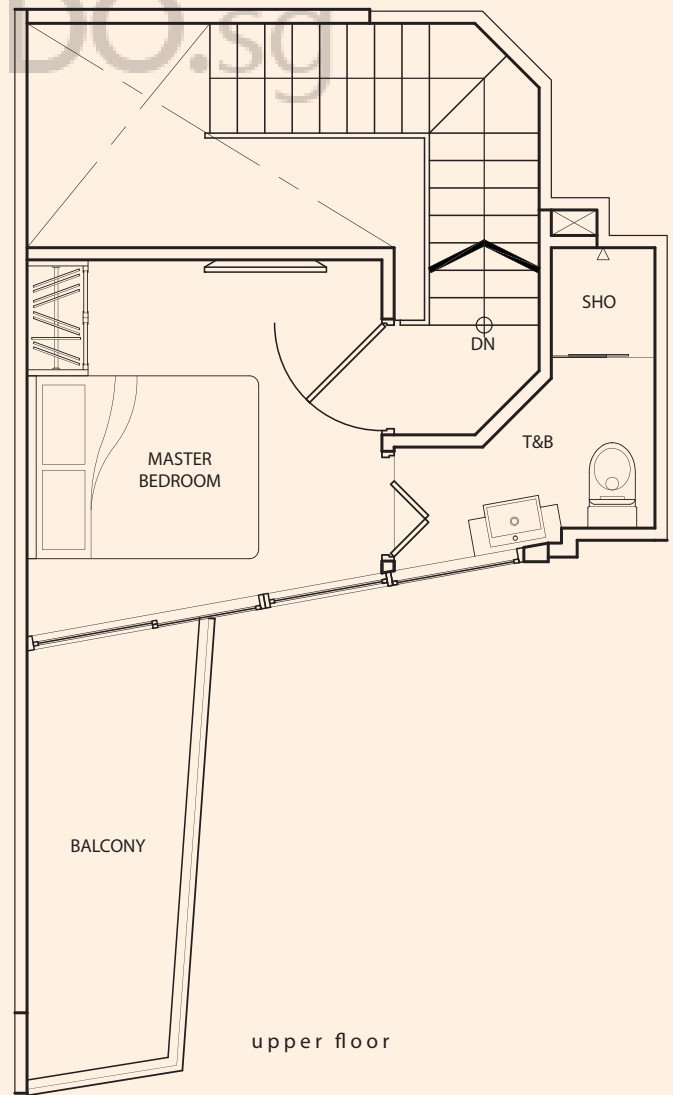

upper floor

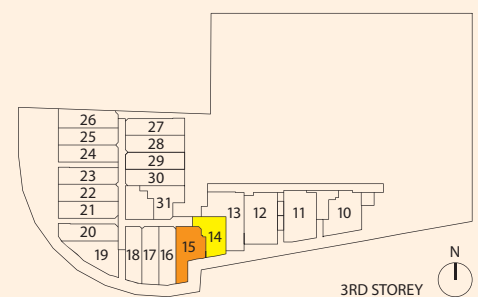

TYPE **A-3G**

1 Bedroom  
+ 2 Bathroom  
52 sq m / 560 sq ft

#03-16

Inclusive of Balcony, AC Ledge



lower floor

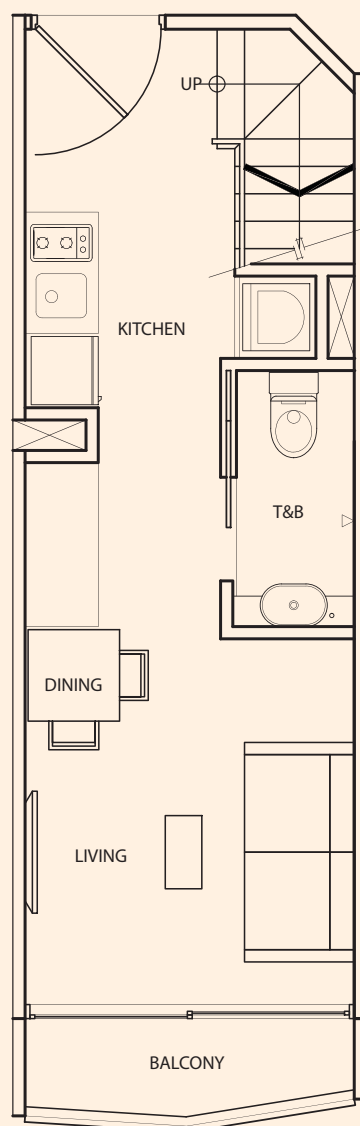

upper floor

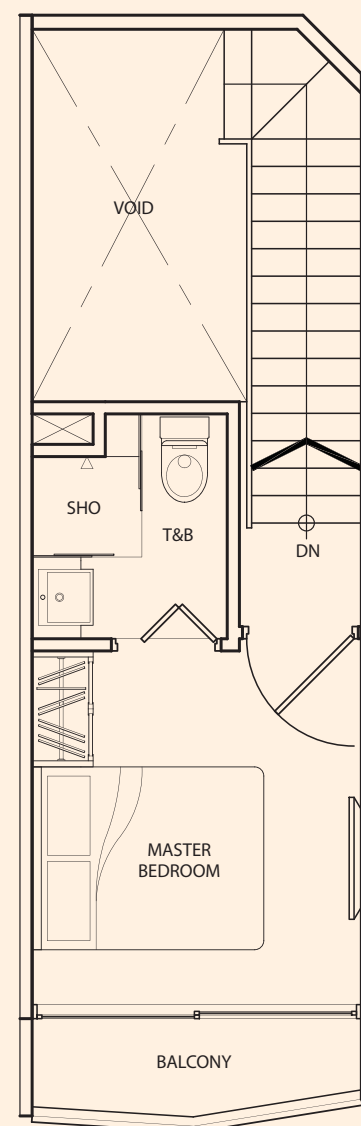

TYPE **A-3H**

1 Bedroom  
+ 2 Bathroom  
52 sq m / 560 sq ft

#03-17

Inclusive of Balcony, AC Ledge



lower floor

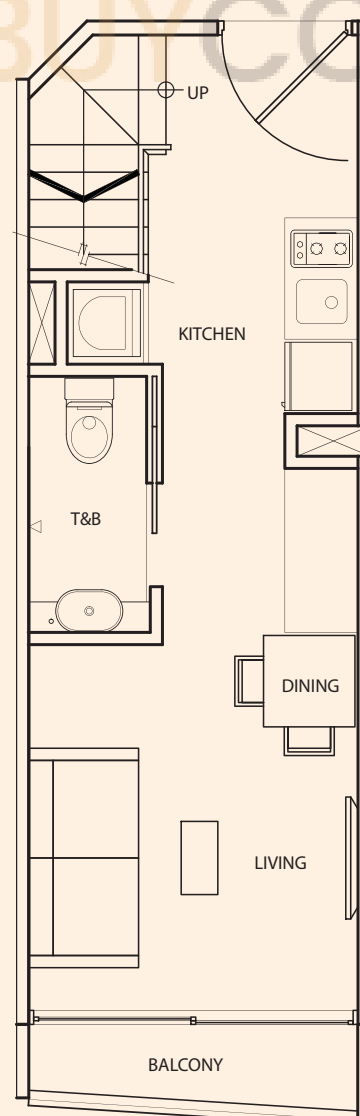

upper floor

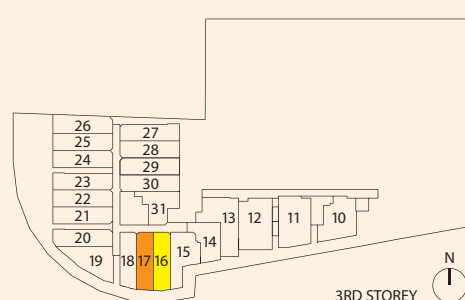
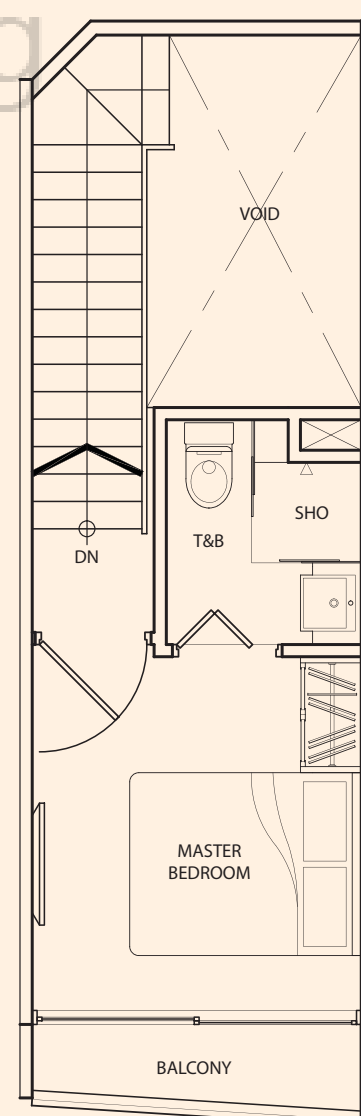

# BLOCK A

## TYPE A-3I

1 Bedroom  
+ 2 Bathroom  
50 sq m / 538 sq ft

#03-18

Inclusive of Balcony, AC Ledge



lower floor

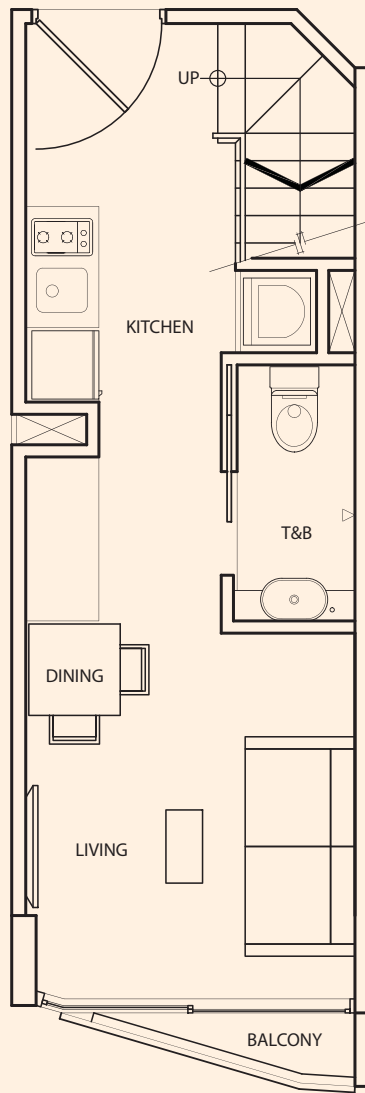

upper floor

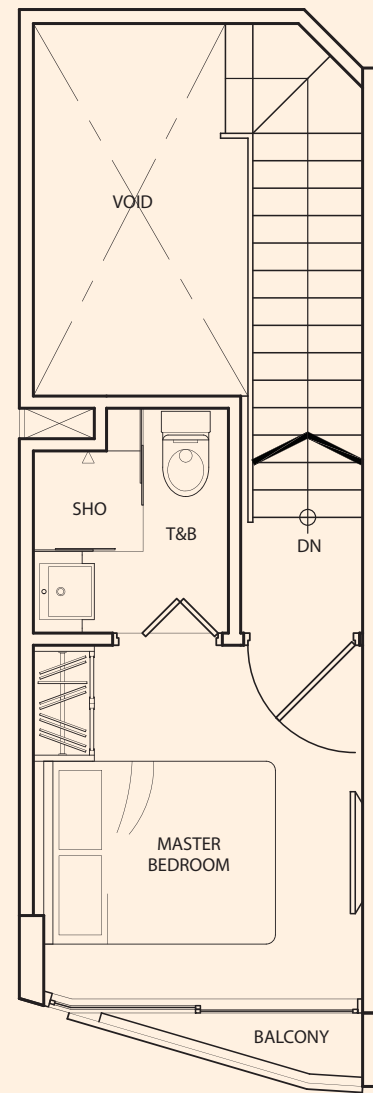

## TYPE A-3J

1 Bedroom  
+ 2 Bathroom  
49 sq m / 527 sq ft

#03-19

Inclusive of Balcony, AC Ledge



lower floor

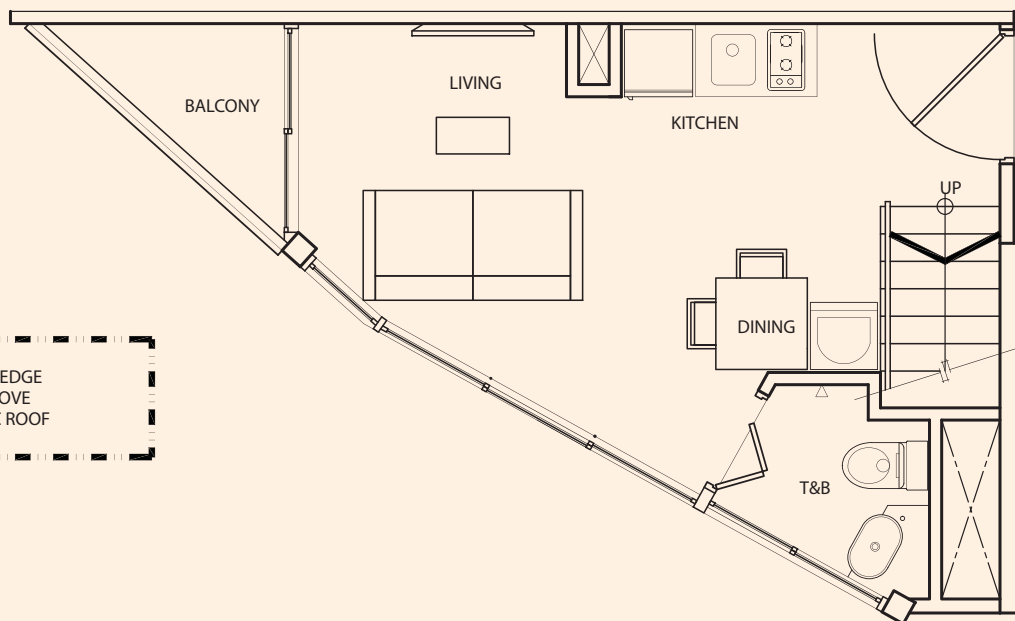

upper floor

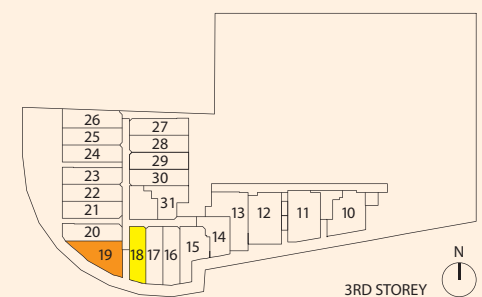
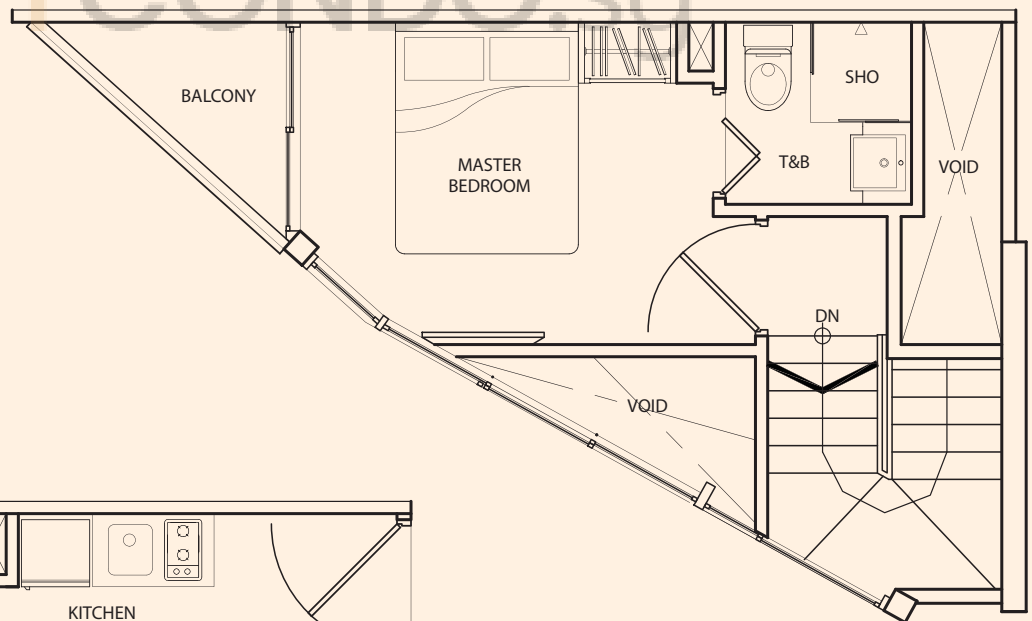

TYPE **A-3K**

1 Bedroom  
+ 2 Bathroom  
55 sq m / 592 sq ft

#03-20

Inclusive of Balcony, AC Ledge

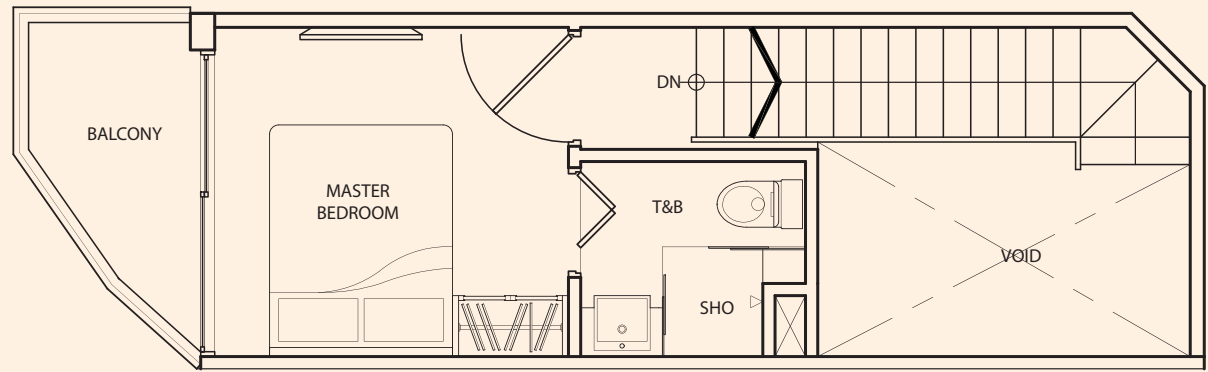

upper floor

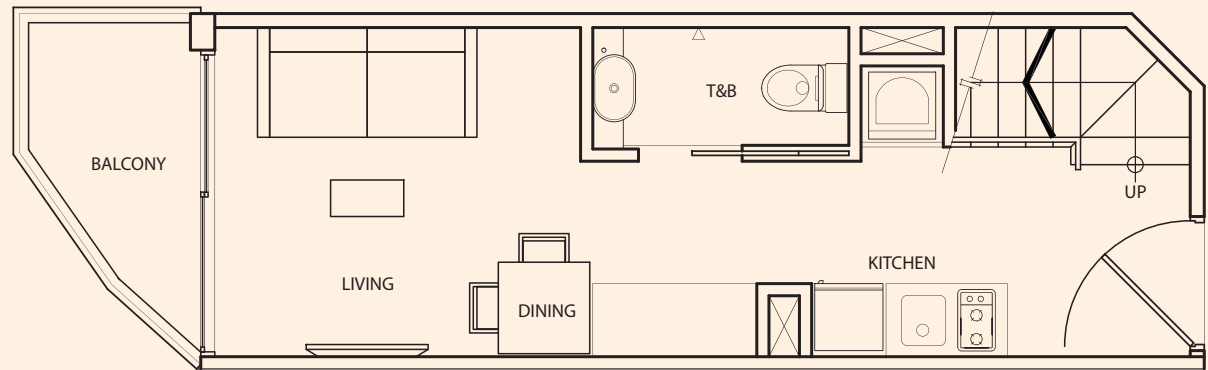

lower floor



TYPE **A-3L**

1 Bedroom  
+ 2 Bathroom  
57 sq m / 613 sq ft

#03-21

#03-23

#03-24

Inclusive of Balcony, AC Ledge

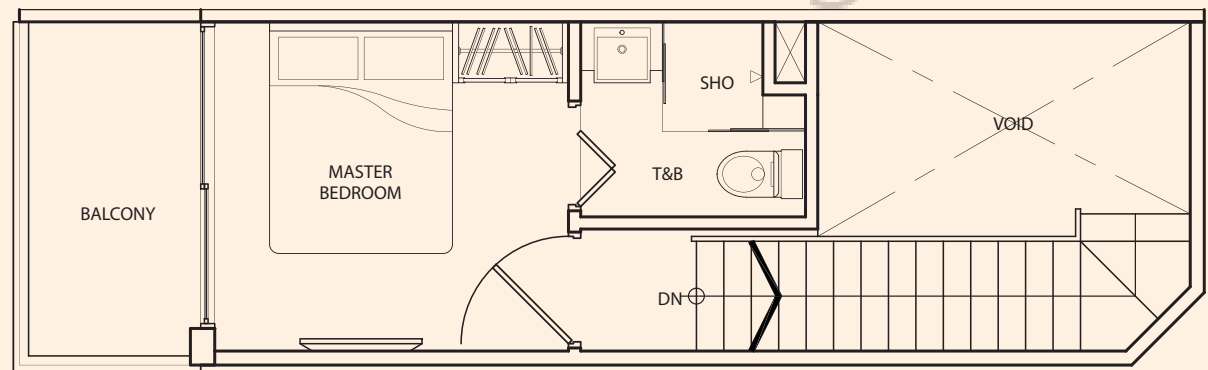

upper floor

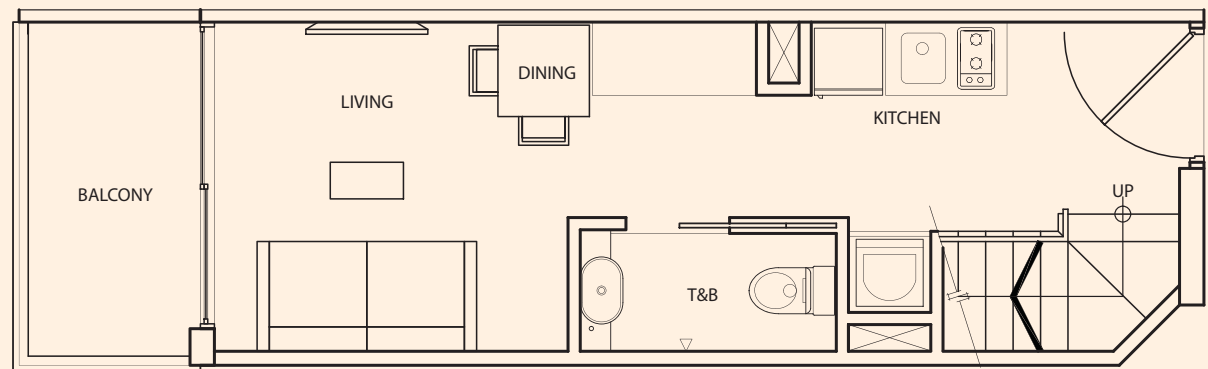

lower floor

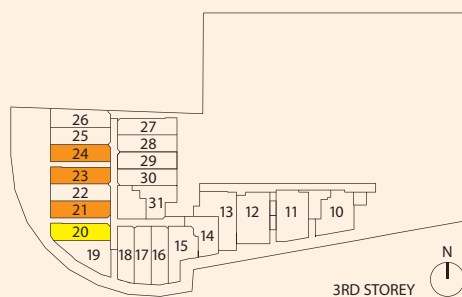

TYPE **A-3M**

1 Bedroom  
+ 2 Bathroom  
57 sq m / 613 sq ft

#03-22

Inclusive of Balcony, AC Ledge

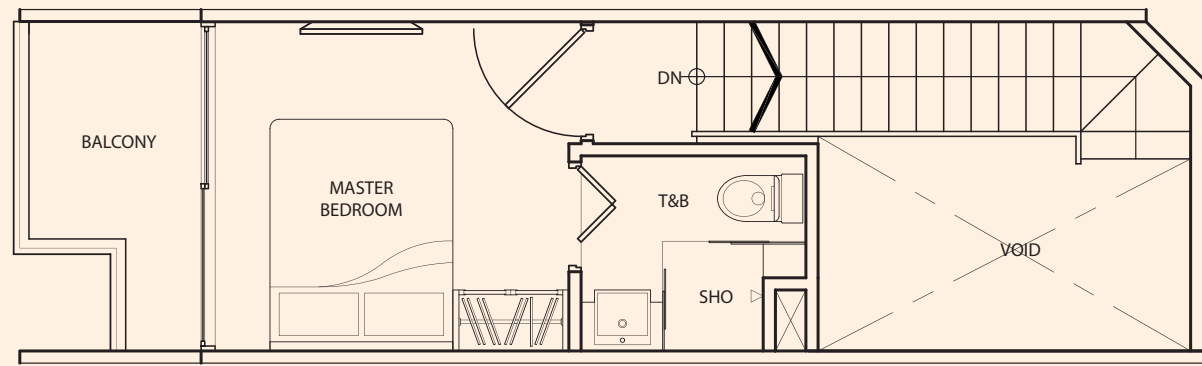

upper floor

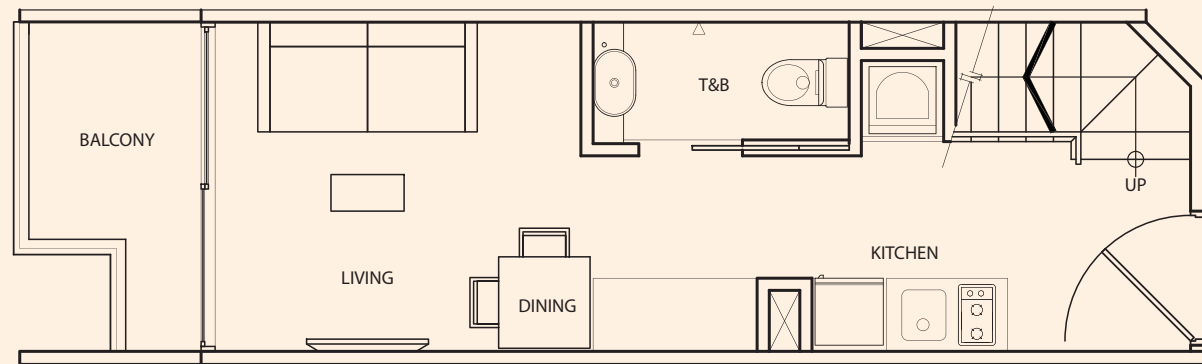

lower floor



TYPE **A-3N**

1 Bedroom  
+ 2 Bathroom  
57 sq m / 613 sq ft

#03-25

Inclusive of Balcony, AC Ledge

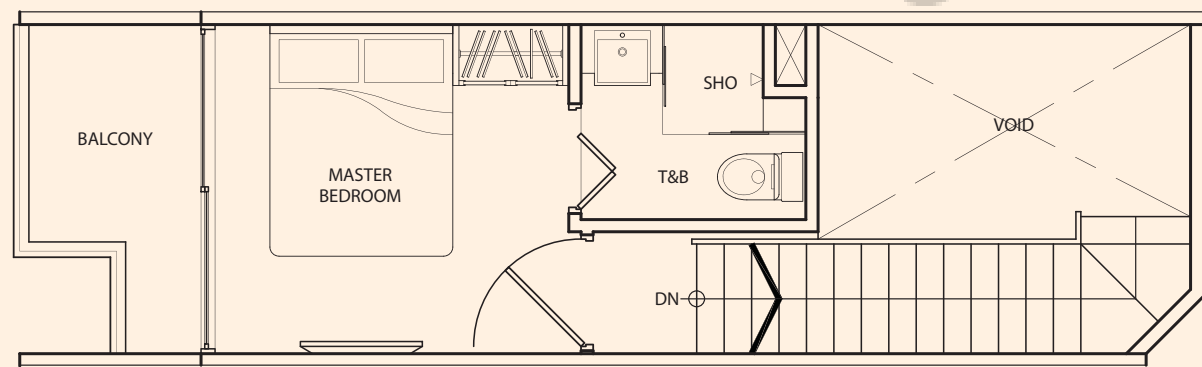

upper floor

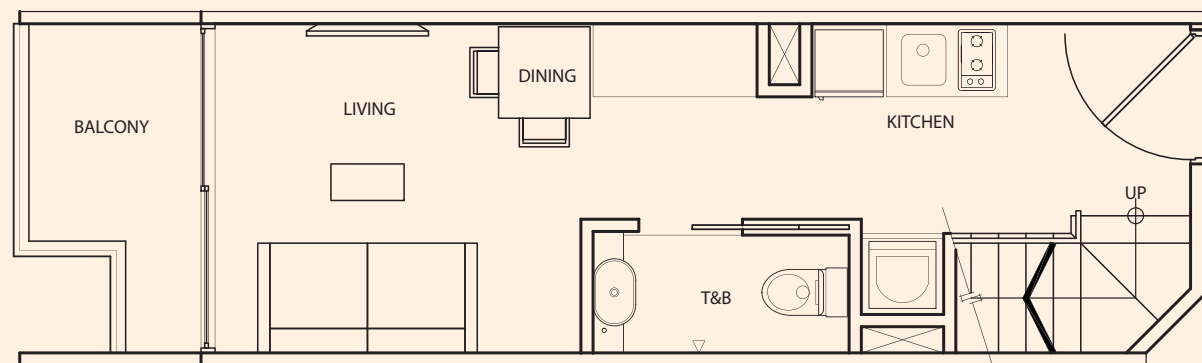

lower floor

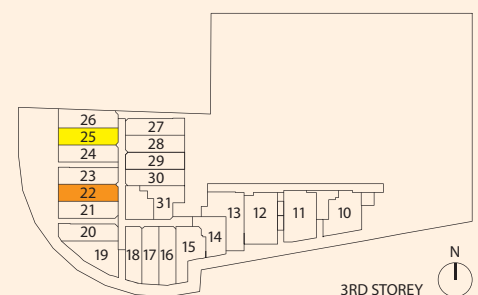

3RD STOREY

TYPE **A-30**

1 Bedroom  
+ 2 Bathroom  
59 sq m / 635 sq ft

#03-26

Inclusive of Balcony, AC Ledge

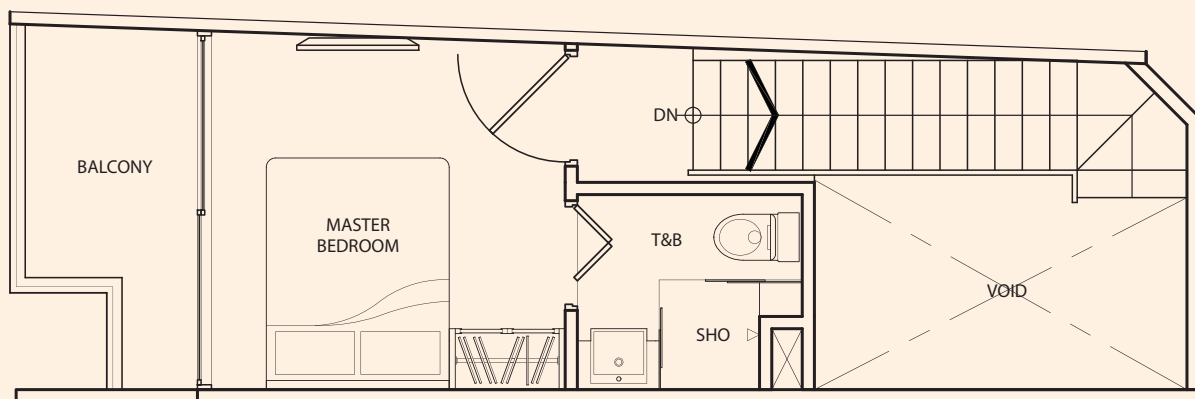

upper floor

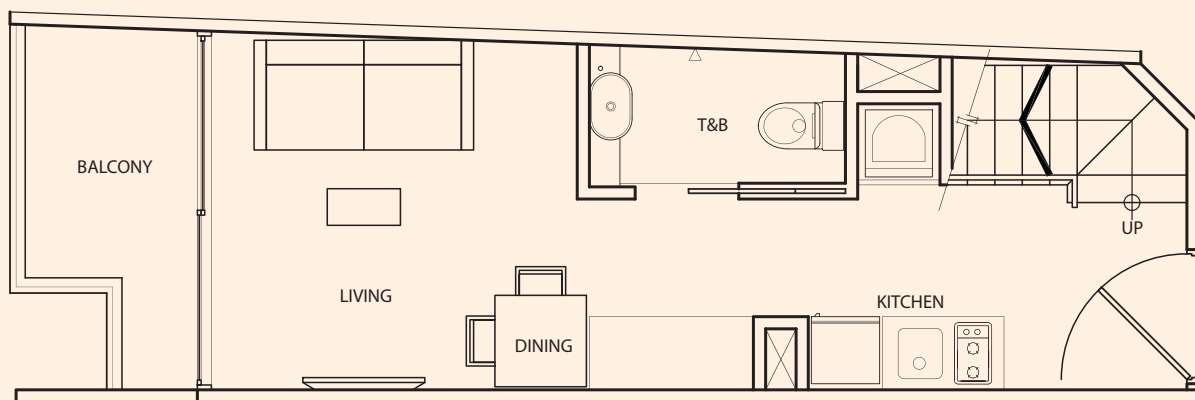

lower floor



TYPE **A-3P**

1 Bedroom  
+ 2 Bathroom  
57 sq m / 613 sq ft

#03-27

Inclusive of Balcony, AC Ledge

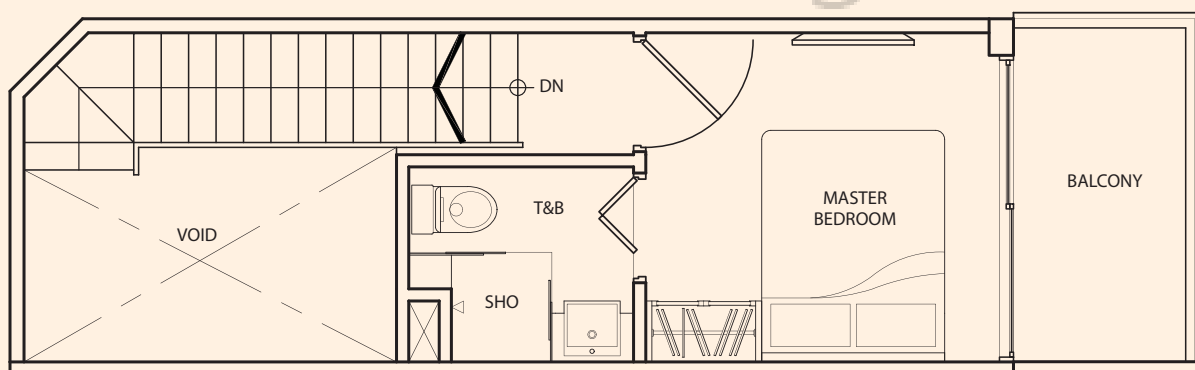

upper floor

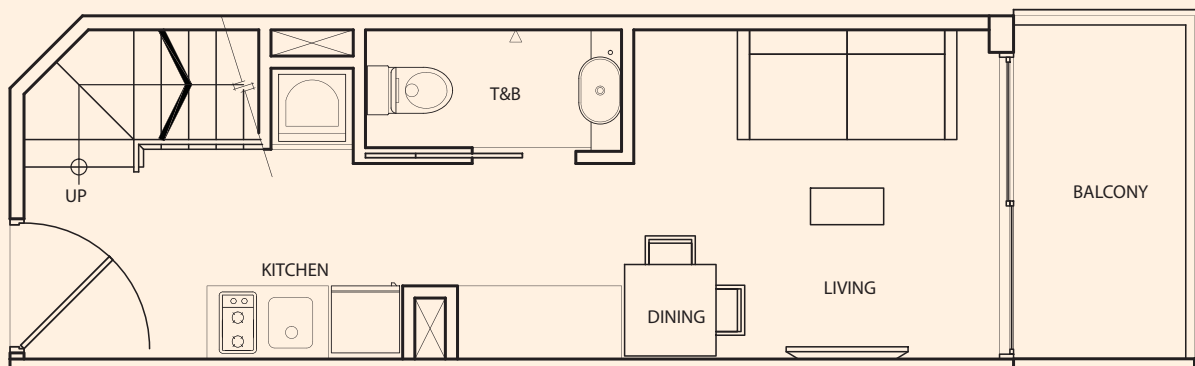

lower floor

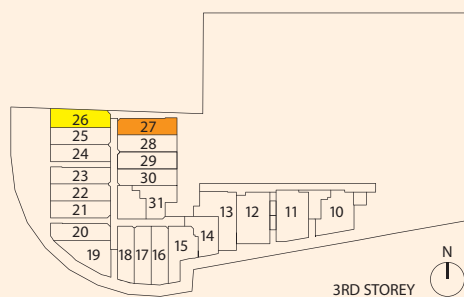

TYPE A-3Q

1 Bedroom  
+ 2 Bathroom  
57 sq m / 613 sq ft

#03-28  
#03-30

Inclusive of Balcony, AC Ledge

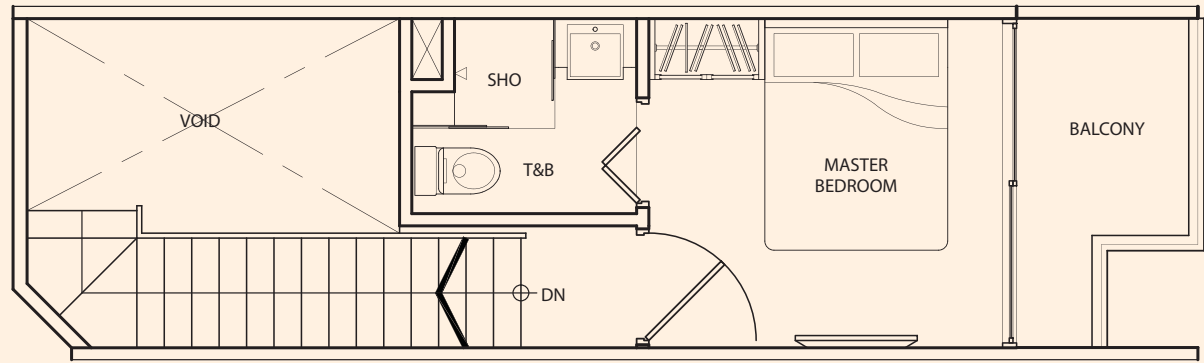

upper floor

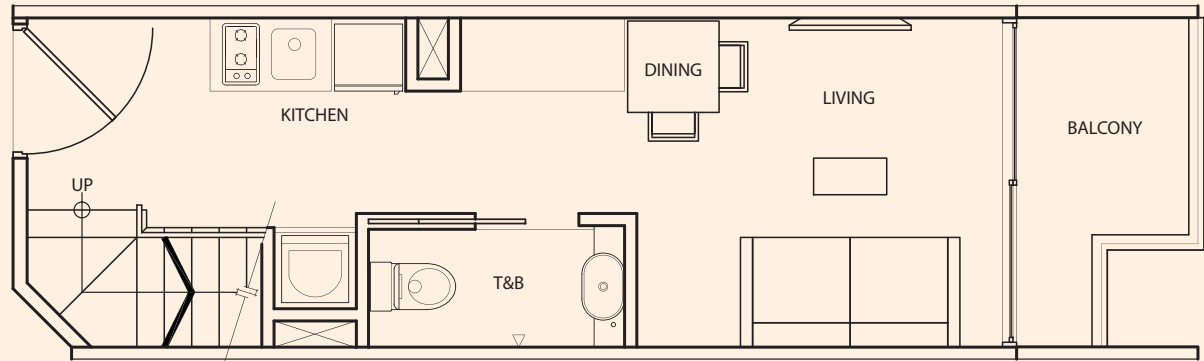

lower floor



TYPE A-3R

1 Bedroom  
+ 2 Bathroom  
57 sq m / 613 sq ft

#03-29

Inclusive of Balcony, AC Ledge

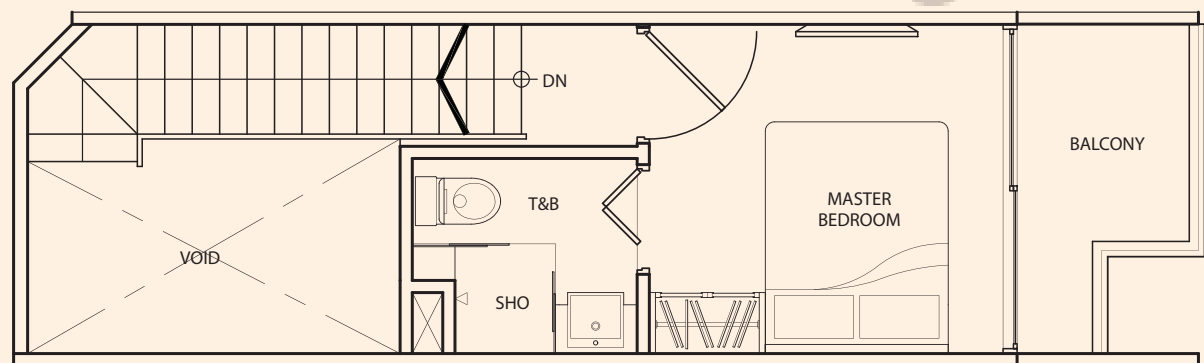

upper floor

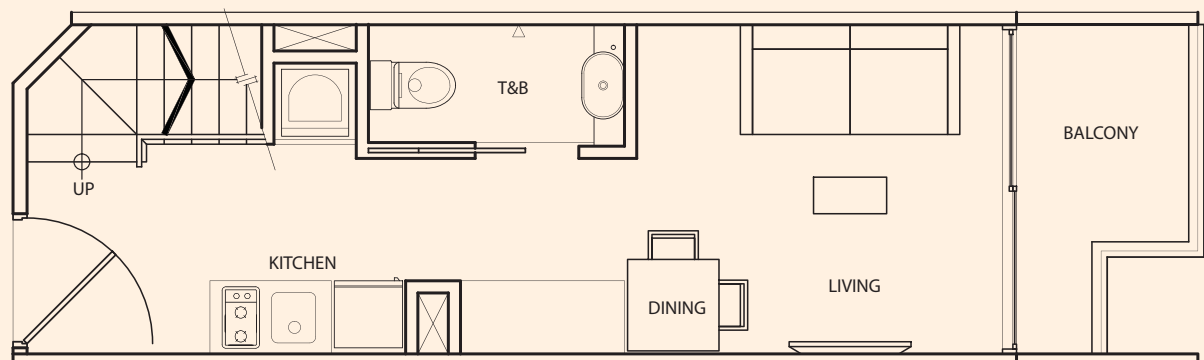

lower floor

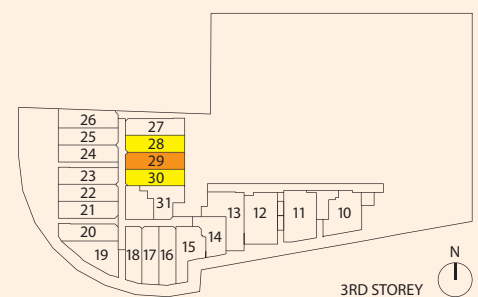

TYPE **A-3S**

1 Bedroom  
+ 2 Bathroom  
55 sq m / 592 sq ft

#03-31

Inclusive of Balcony, AC Ledge

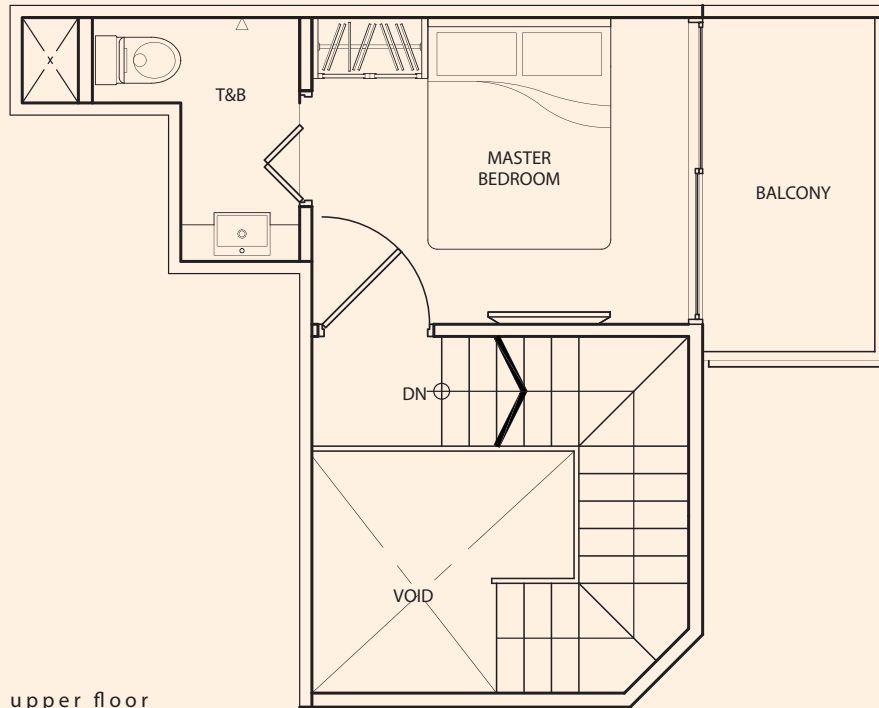

upper floor

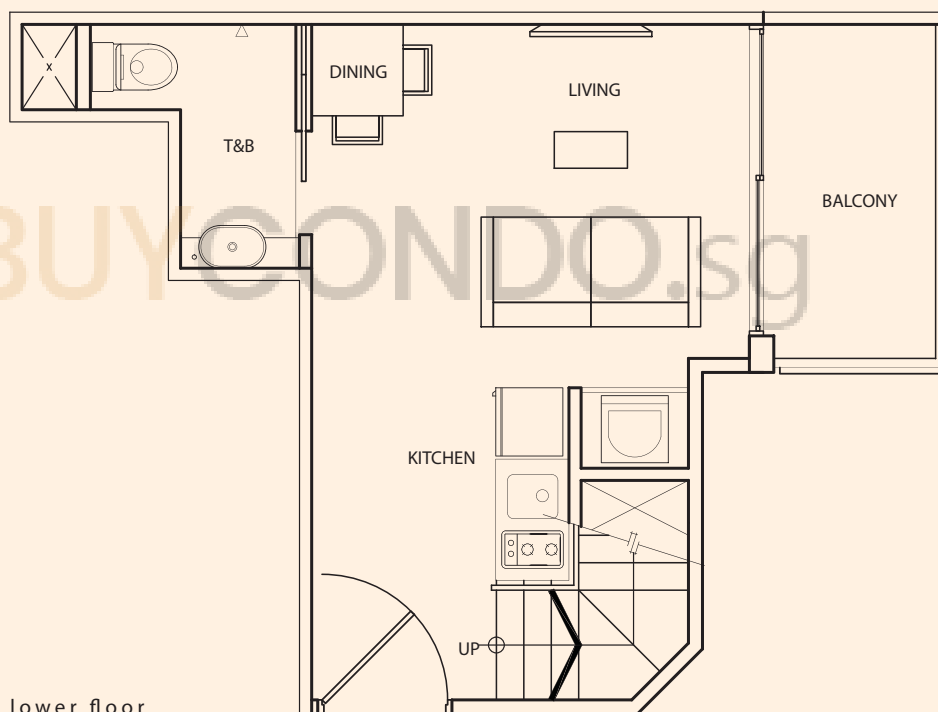

lower floor

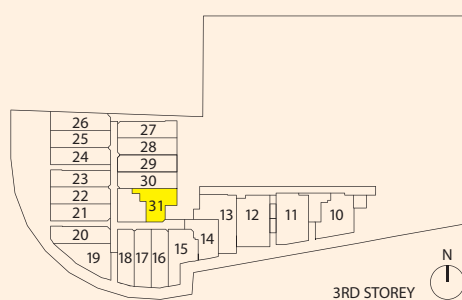



# BLOCK A

## TYPE A-P5E

1 Bedroom  
+ 2 Bathroom  
48 sq m / 517 sq ft

#05-14

Inclusive of Roof Terrace,  
AC Ledge

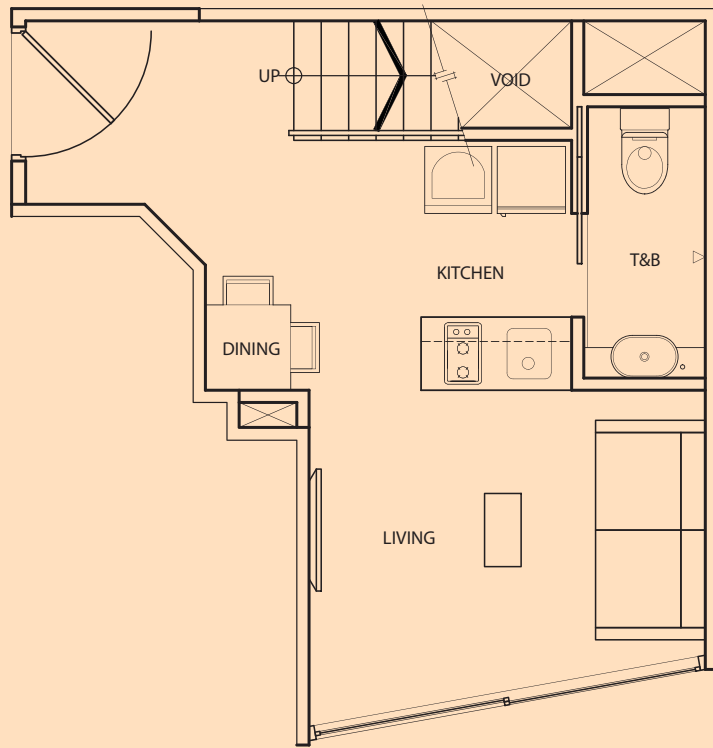

lower floor

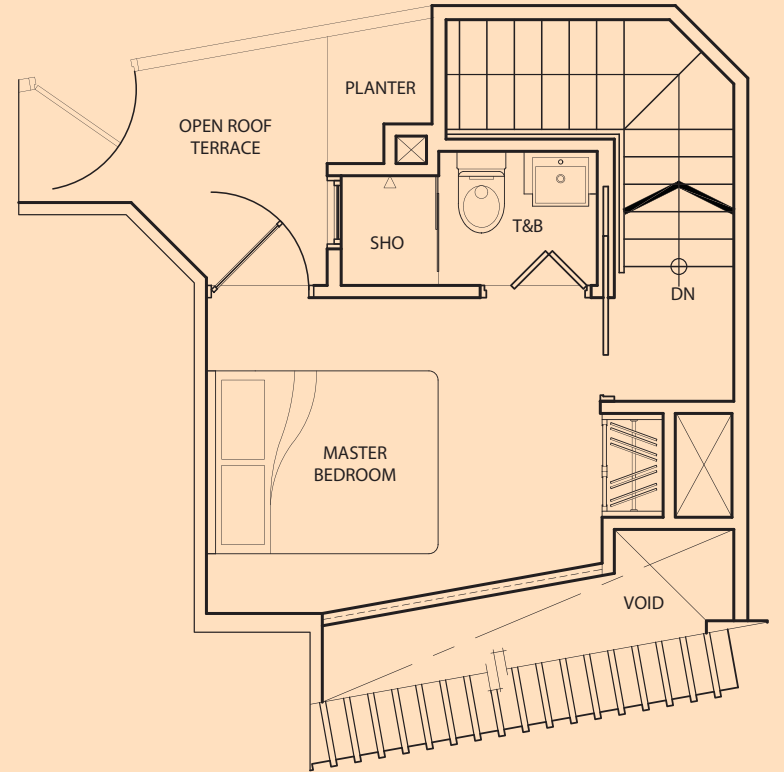

upper floor

## TYPE A-P5F

1 Bedroom  
+ 2 Bathroom  
49 sq m / 527 sq ft

#05-15

Inclusive of Roof Terrace,  
Balcony, AC Ledge

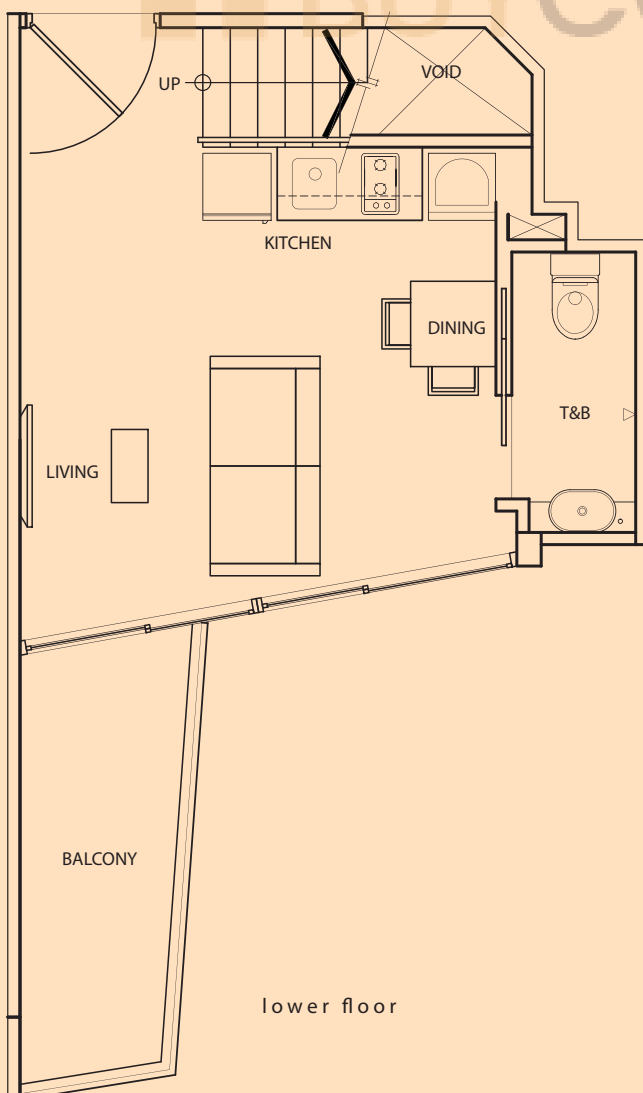

lower floor

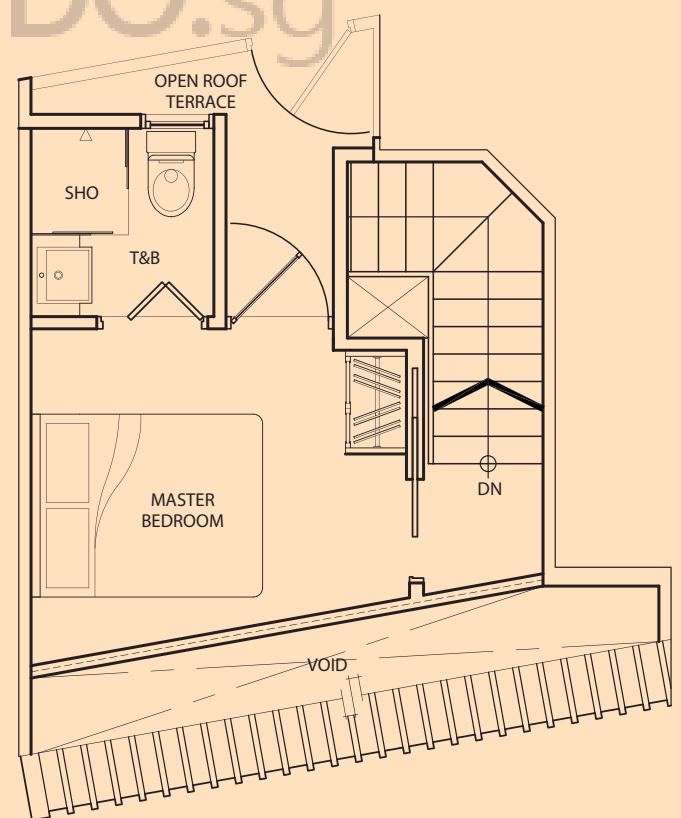

upper floor

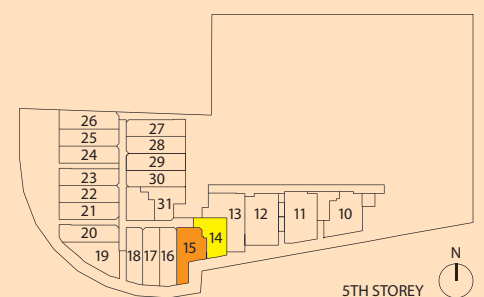

TYPE **A-P5G**

1 Bedroom  
+ 2 Bathroom  
48 sq m / 517 sq ft

#05-16

Inclusive of Roof Terrace,  
Balcony, AC Ledge



lower floor

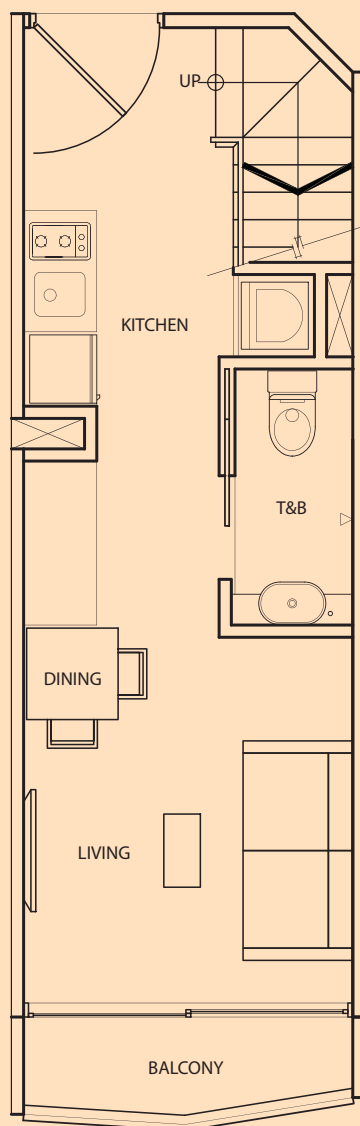

upper floor

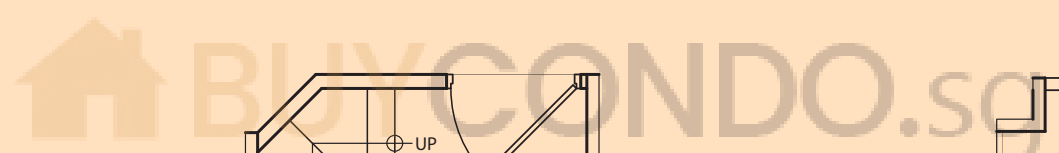
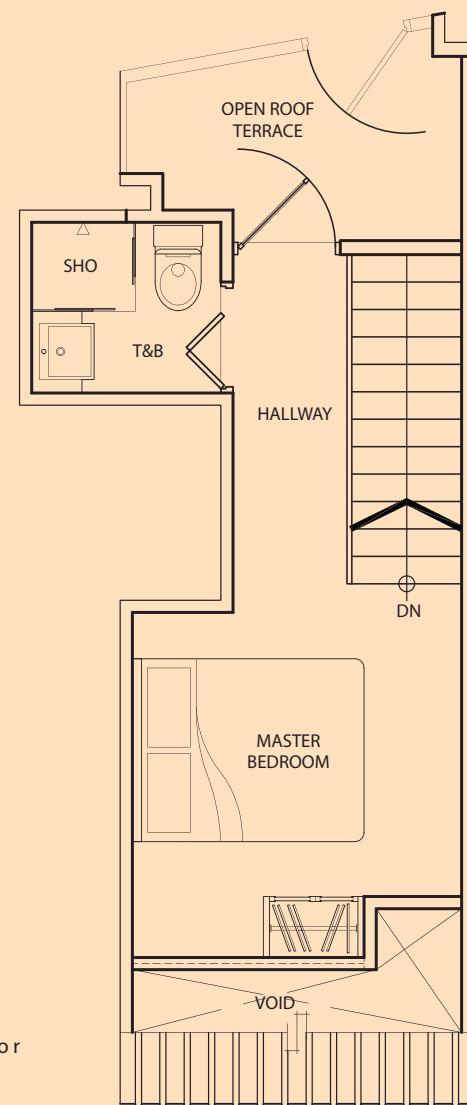

TYPE **A-P5H**

1 Bedroom  
+ 2 Bathroom  
48 sq m / 517 sq ft

#05-17

Inclusive of Roof Terrace,  
Balcony, AC Ledge



lower floor

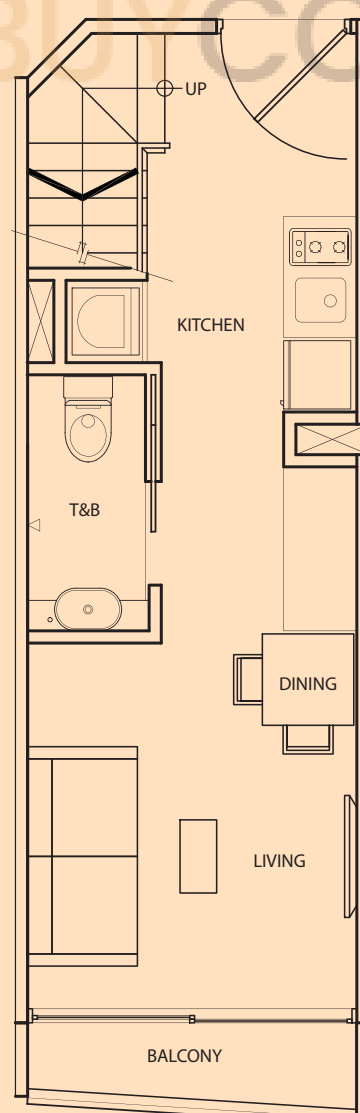

upper floor

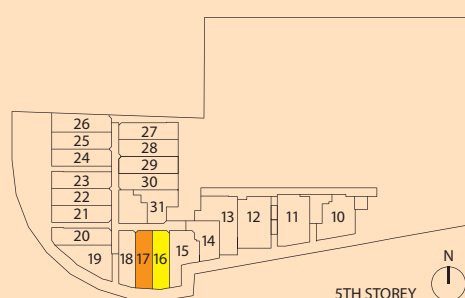
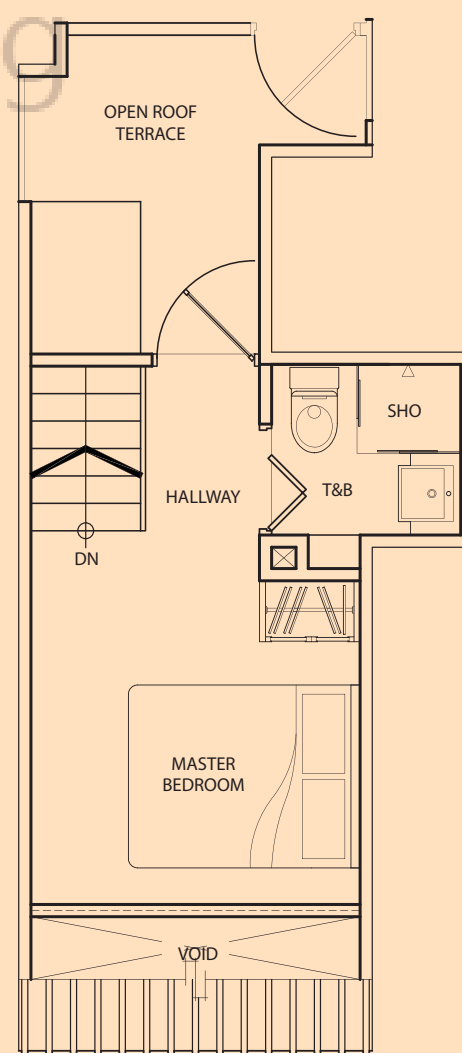

# BLOCK A

## TYPE A-P5I

1 Bedroom  
+ 2 Bathroom  
47 sq m / 506 sq ft

#05-18

Inclusive of Roof Terrace,  
Balcony, AC Ledge



lower floor

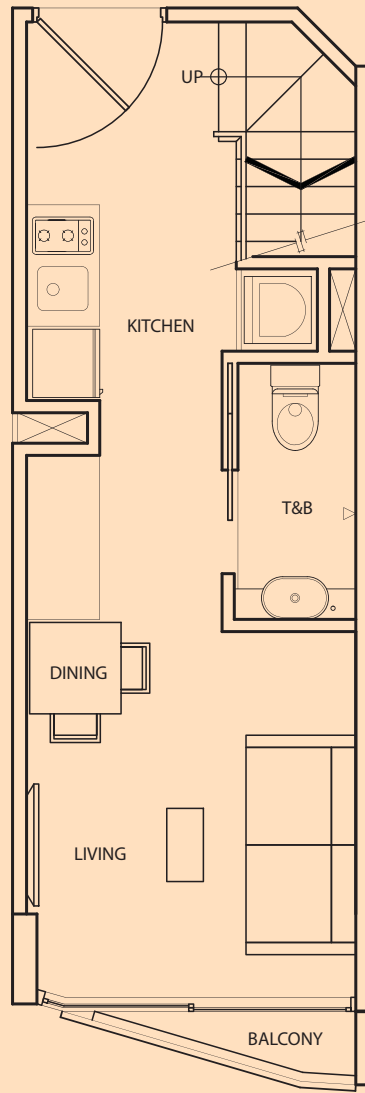

upper floor

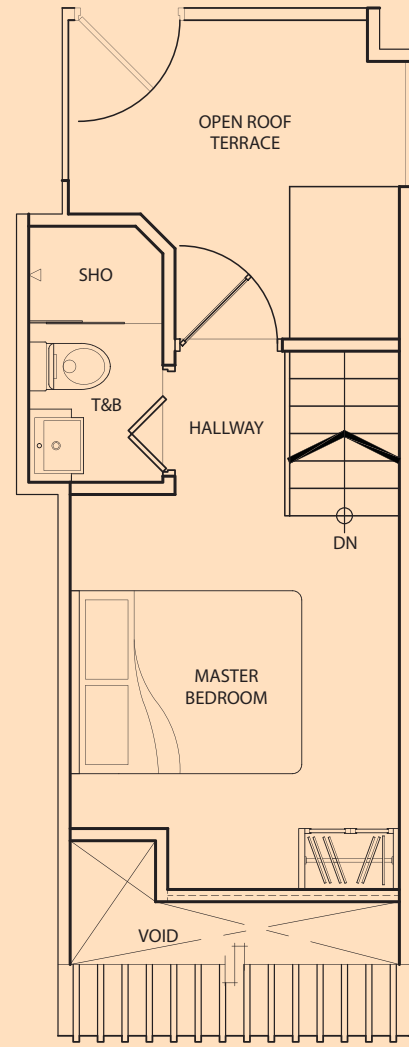

## TYPE A-P5J

1 Bedroom  
+ 2 Bathroom  
52 sq m / 560 sq ft

#05-19

Inclusive of Roof Terrace,  
Balcony, AC Ledge



lower floor

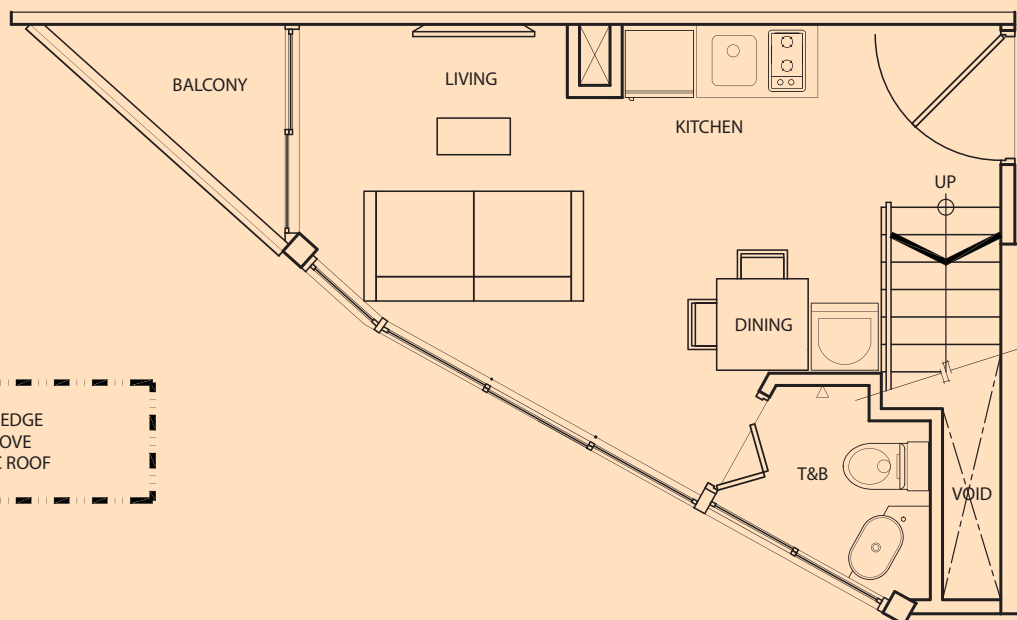

upper floor

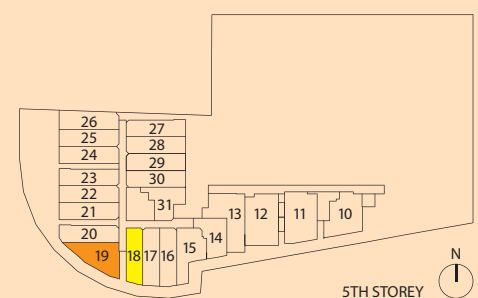
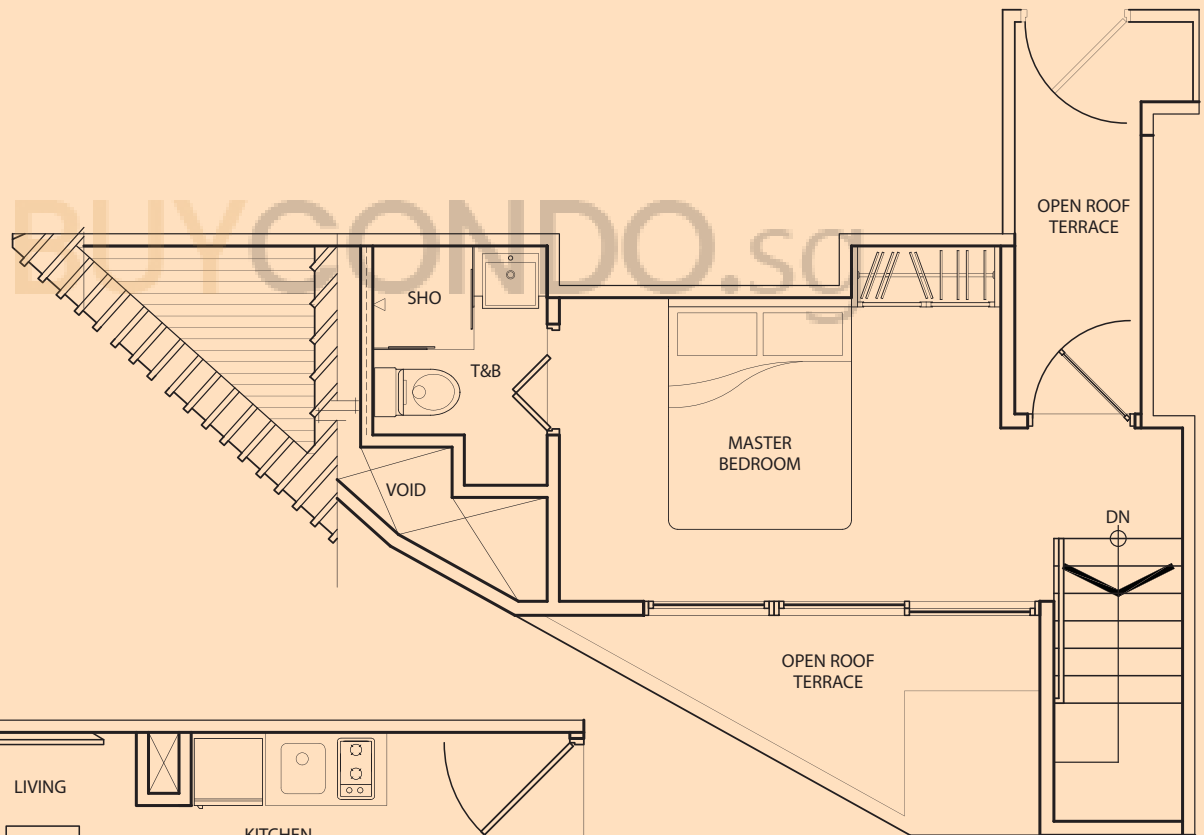

TYPE **A-P5K**

1 Bedroom  
+ 2 Bathroom  
50 sq m / 538 sq ft

#05-20

Inclusive of Roof Terrace,  
Balcony, AC Ledge

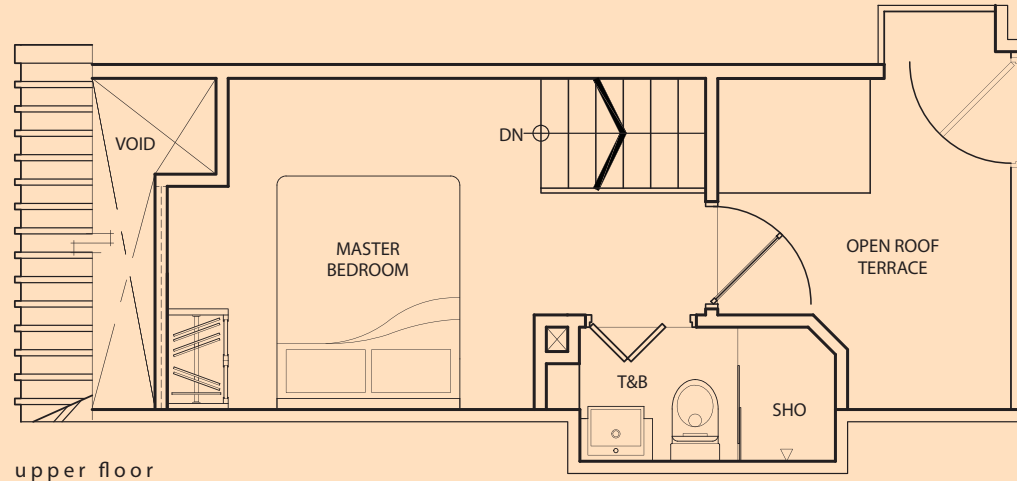

upper floor

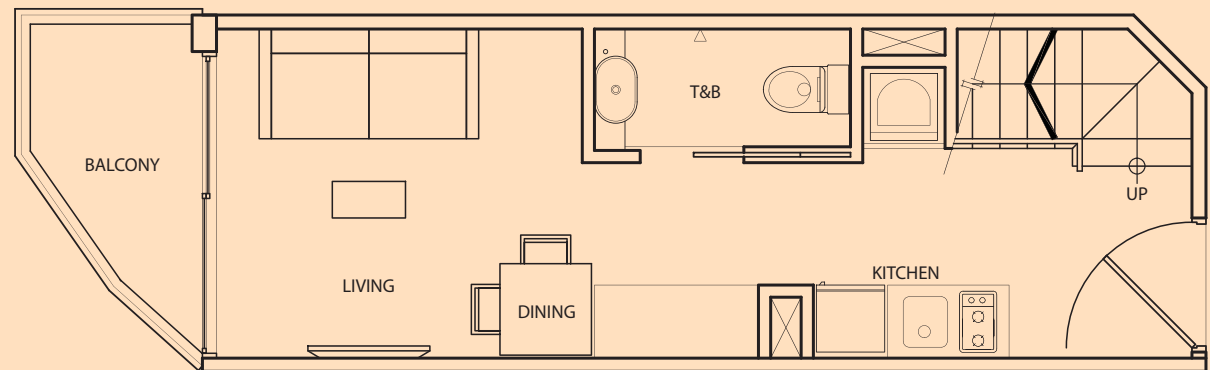

lower floor



TYPE **A-P5L**

1 Bedroom  
+ 2 Bathroom  
51 sq m / 549 sq ft

#05-21

Inclusive of Roof Terrace,  
Balcony, AC Ledge

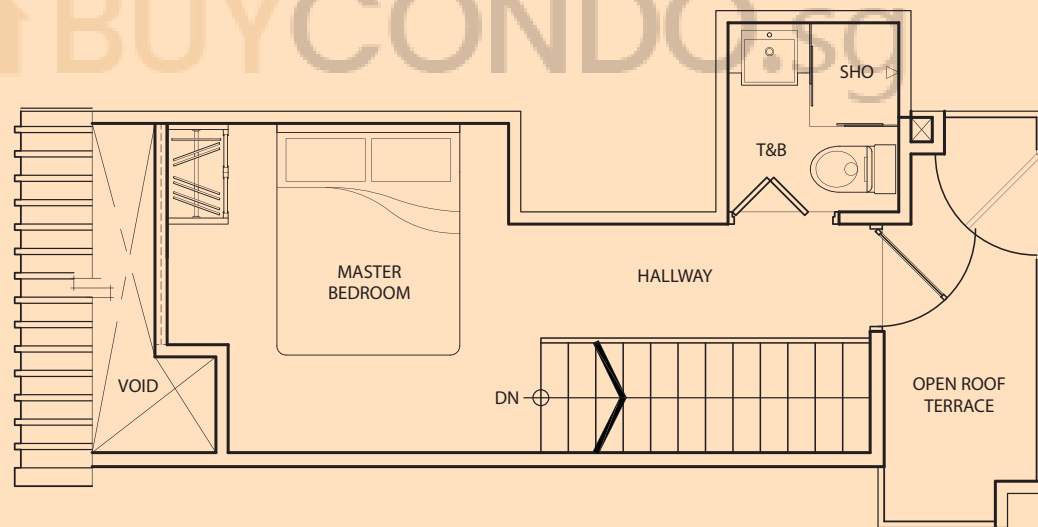

upper floor

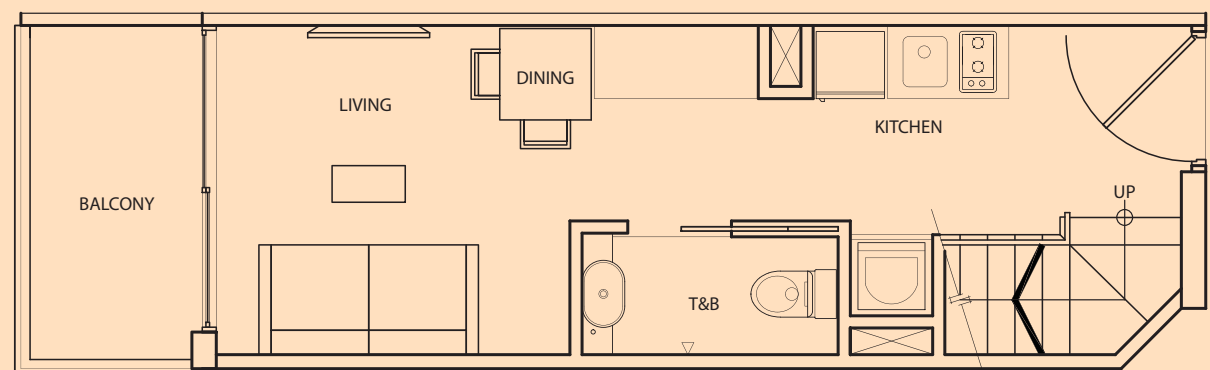

lower floor

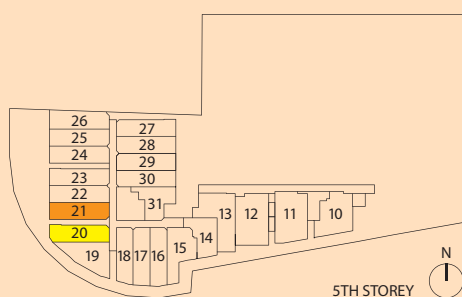

# BLOCK A

## TYPE A-P5M

1 Bedroom  
+ 2 Bathroom  
51 sq m / 549 sq ft

#05-22

Inclusive of Roof Terrace,  
Balcony, AC Ledge

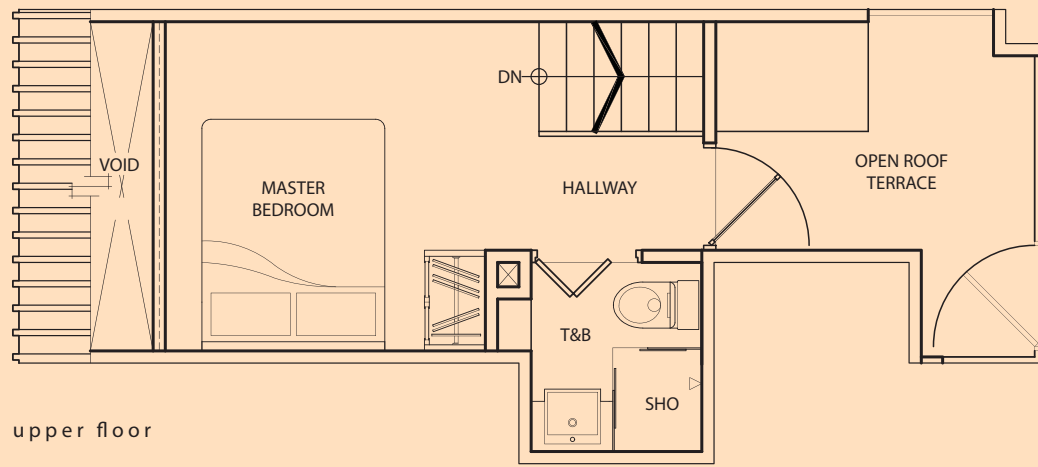

upper floor

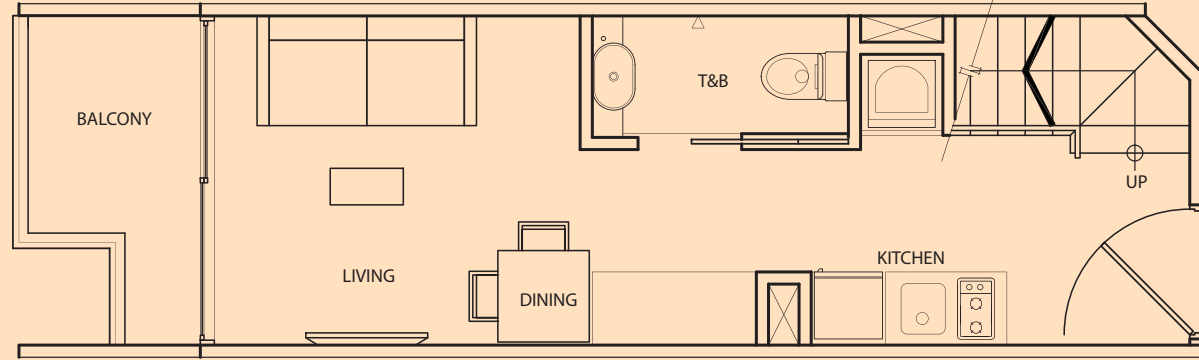

lower floor



## TYPE A-P5MA

1 Bedroom  
+ 2 Bathroom  
52 sq m / 560 sq ft

#05-23

#05-24

Inclusive of Roof Terrace,  
Balcony, AC Ledge

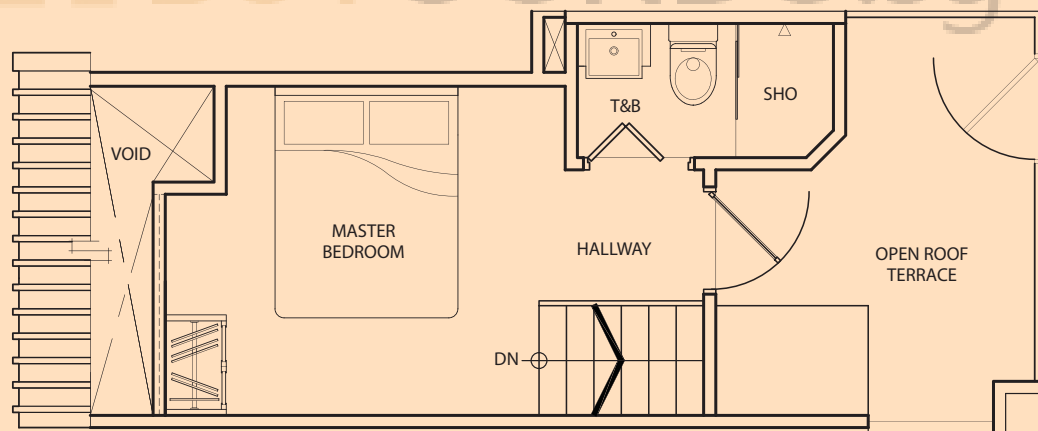

upper floor

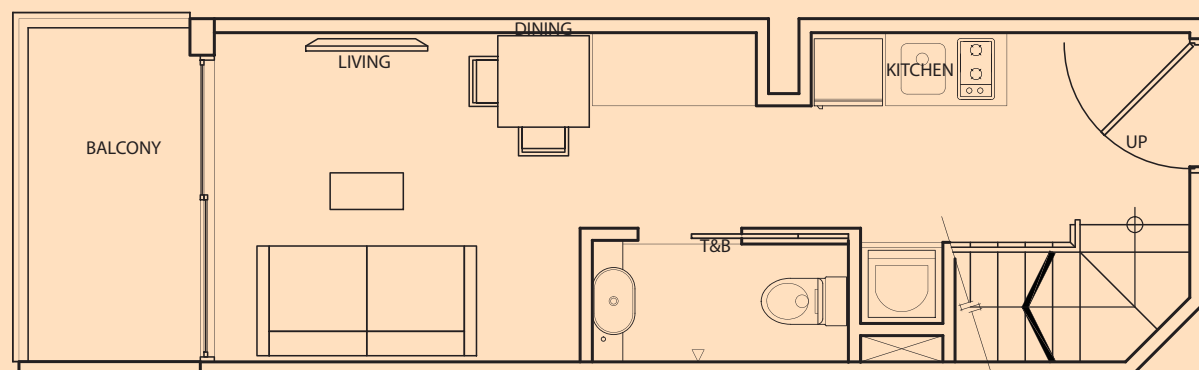

lower floor

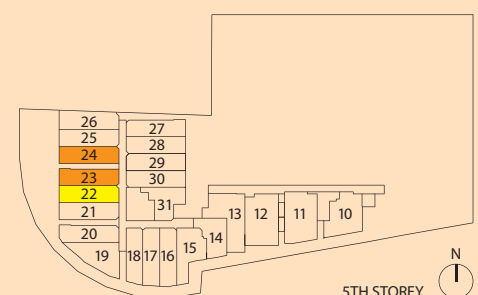

TYPE **A-P5N**

1 Bedroom  
+ 2 Bathroom  
51 sq m / 549 sq ft

#05-25

Inclusive of Roof Terrace,  
Balcony, AC Ledge

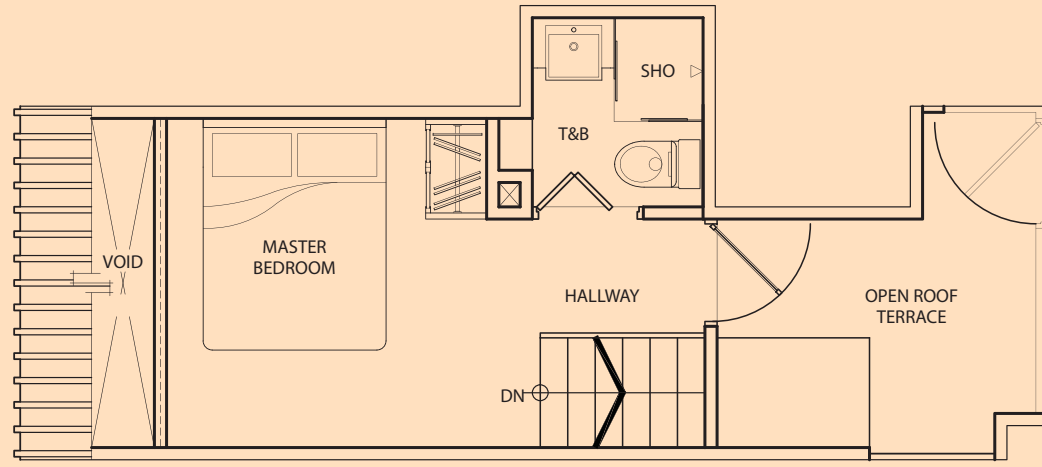

upper floor

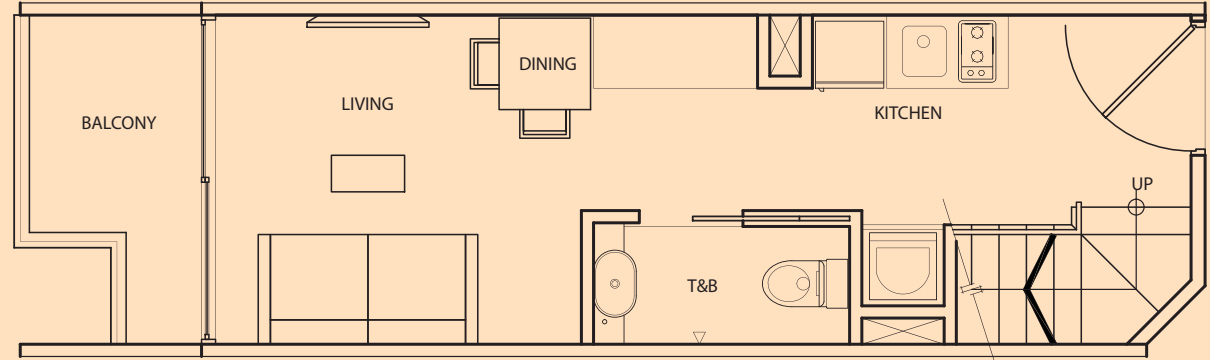

lower floor



TYPE **A-P50**

1 Bedroom  
+ 2 Bathroom  
53 sq m / 570 sq ft

#05-26

Inclusive of Roof Terrace,  
Balcony, AC Ledge

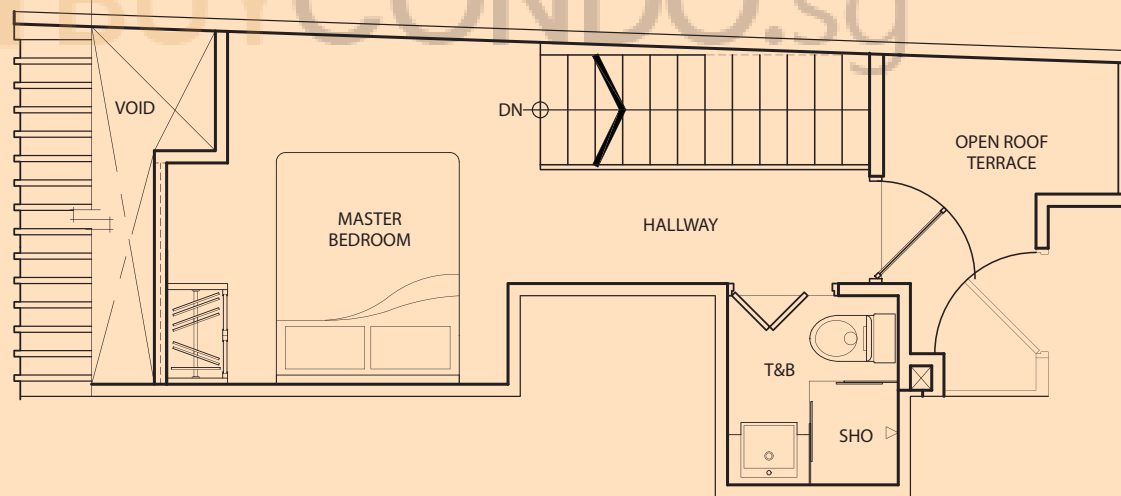

upper floor

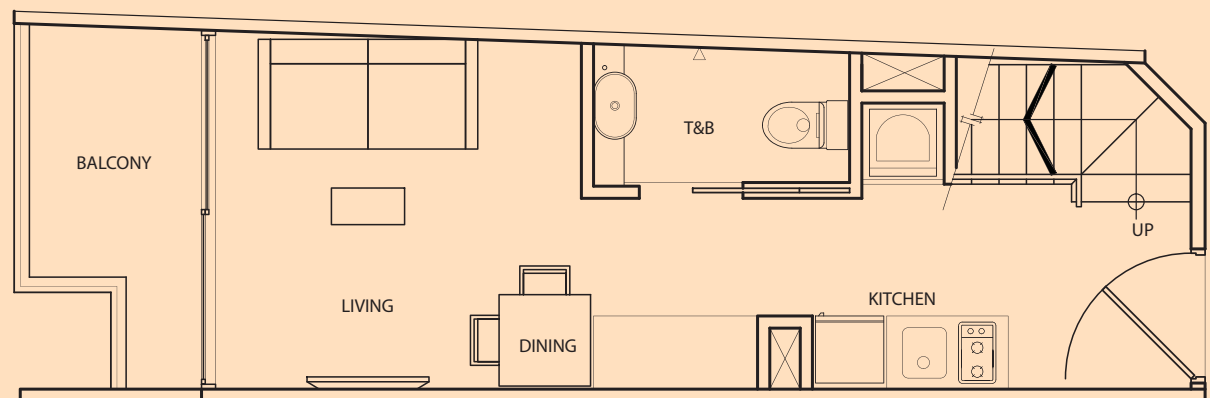

lower floor

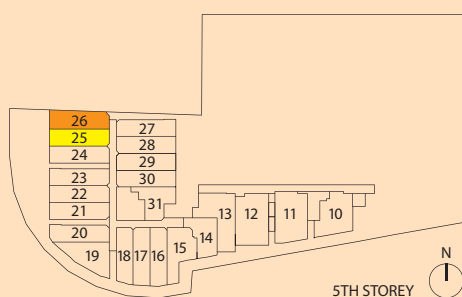

# BLOCK A

## TYPE A-P5P

1 Bedroom  
+ 2 Bathroom  
54 sq m / 581 sq ft

#05-27

Inclusive of Roof Terrace,  
Balcony, AC Ledge

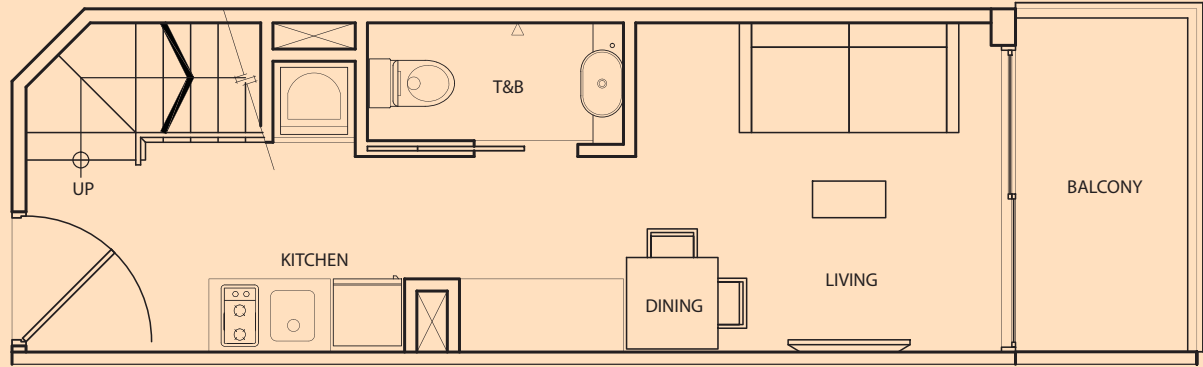
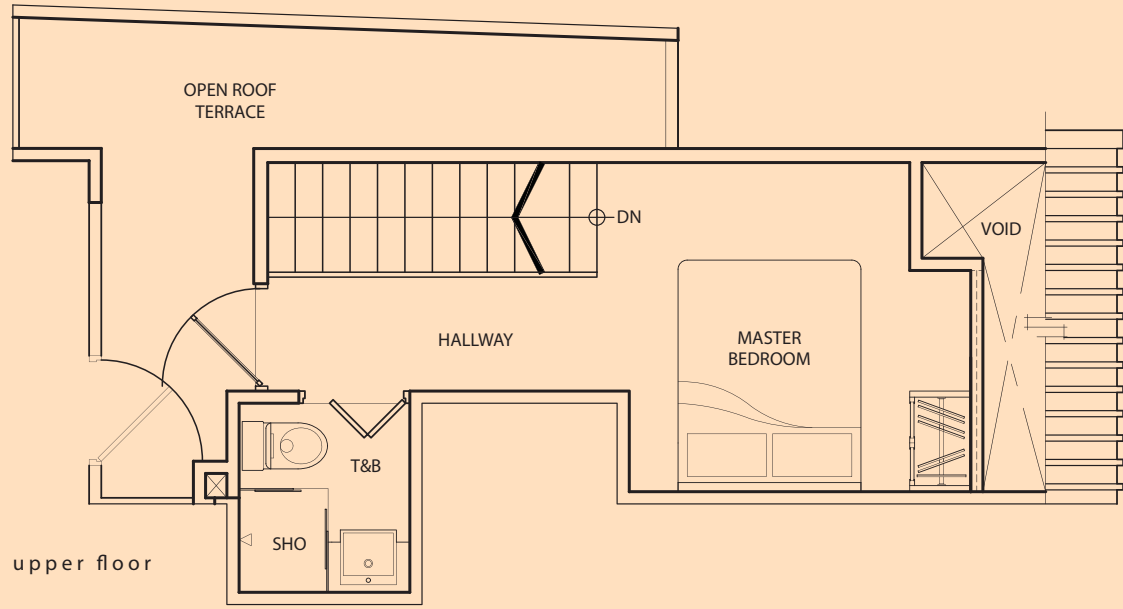

lower floor

## TYPE A-P5Q

1 Bedroom  
+ 2 Bathroom  
51 sq m / 549 sq ft

#05-28

#05-30

Inclusive of Roof Terrace,  
Balcony, AC Ledge

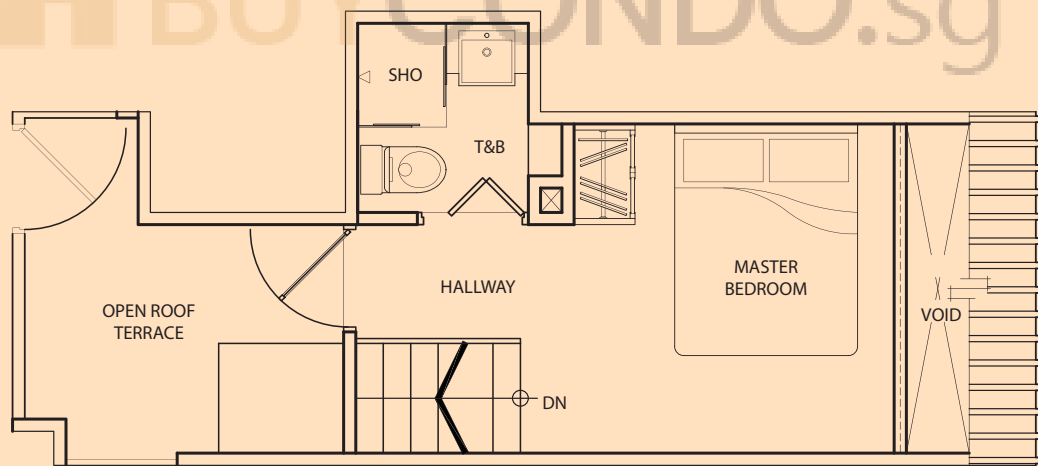

upper floor

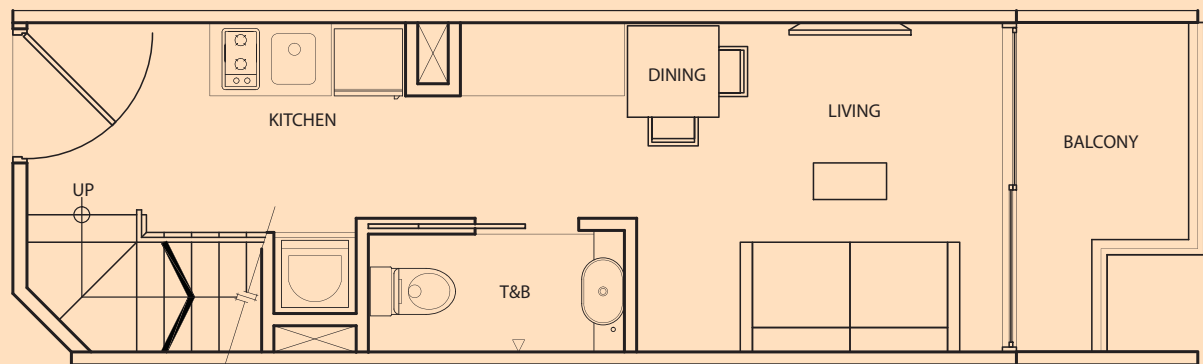

lower floor

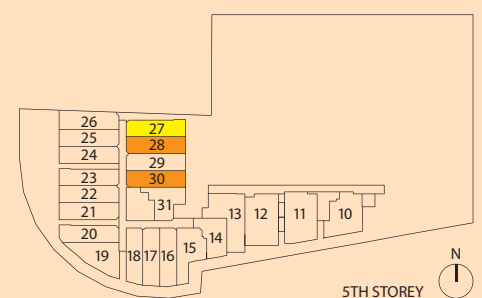

TYPE **A-P5R**

1 Bedroom  
+ 2 Bathroom  
51 sq m / 549 sq ft

#05-29

Inclusive of Roof Terrace,  
Balcony, AC Ledge

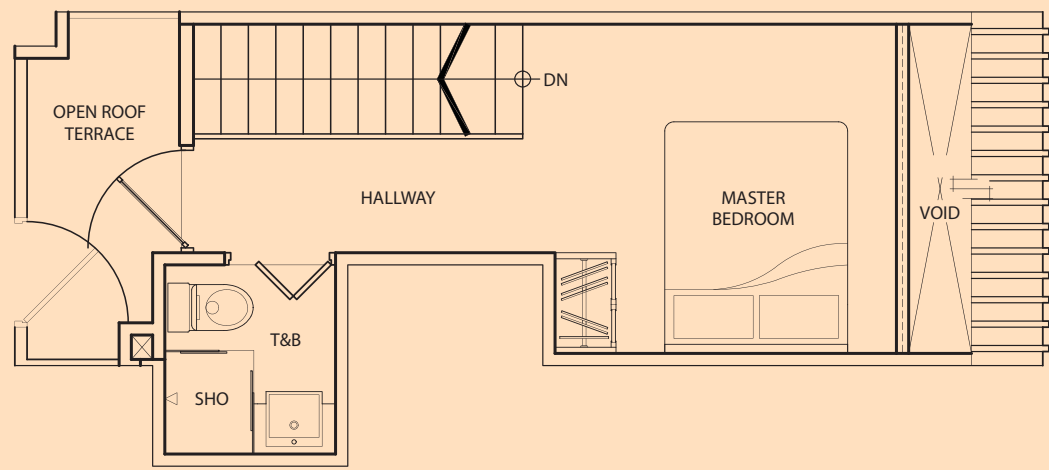

upper floor

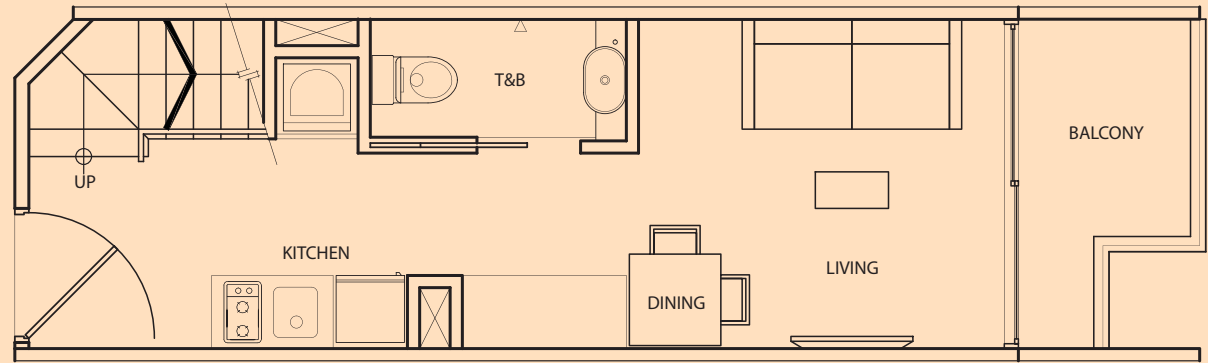

lower floor



TYPE **A-P5S**

1 Bedroom  
+ 2 Bathroom  
50 sq m / 538 sq ft

#05-31

Inclusive of Roof Terrace,  
Balcony, AC Ledge

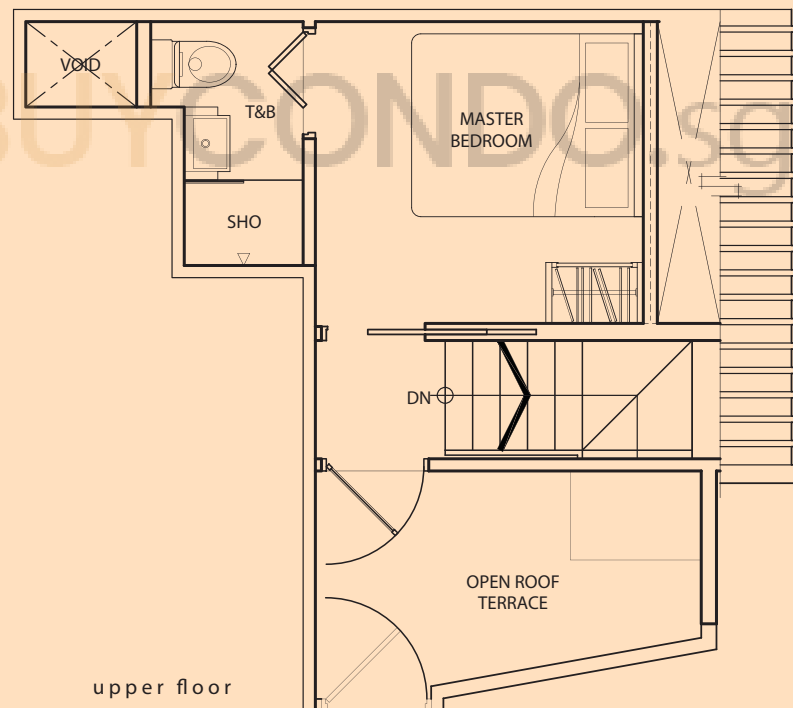

upper floor

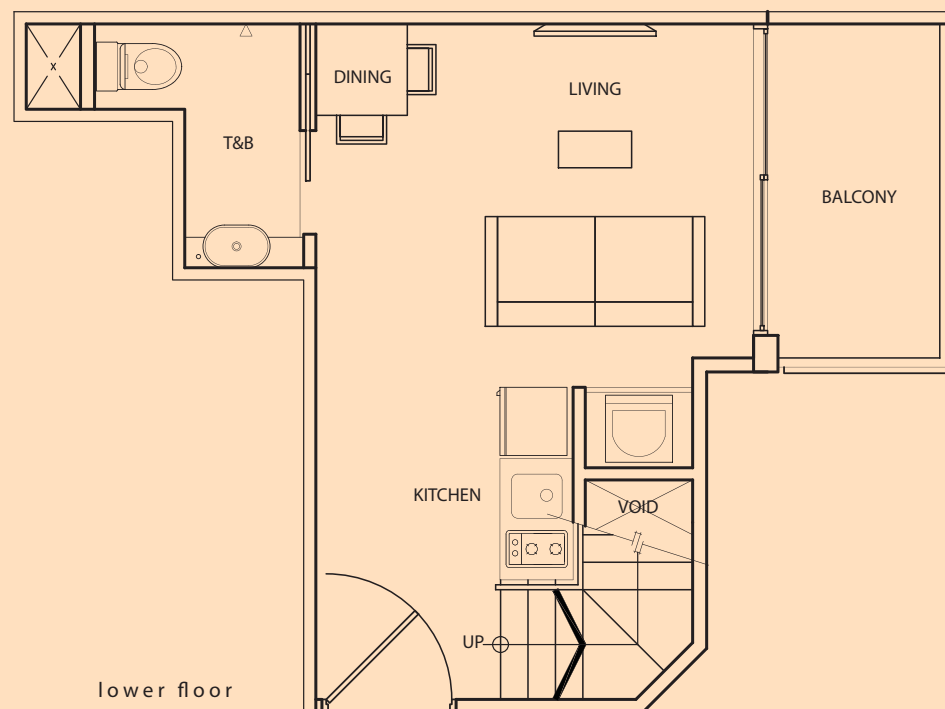

lower floor

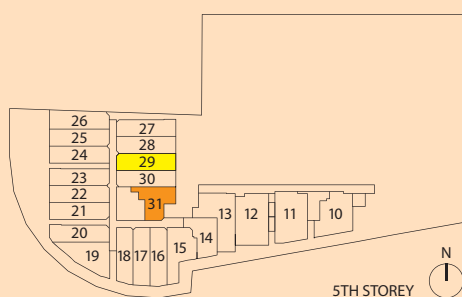



TYPE **B-1A**

1 Bedroom  
+ 2 Bathroom  
44 sq m / 474 sq ft

#01-10

Inclusive of PES, AC Ledge

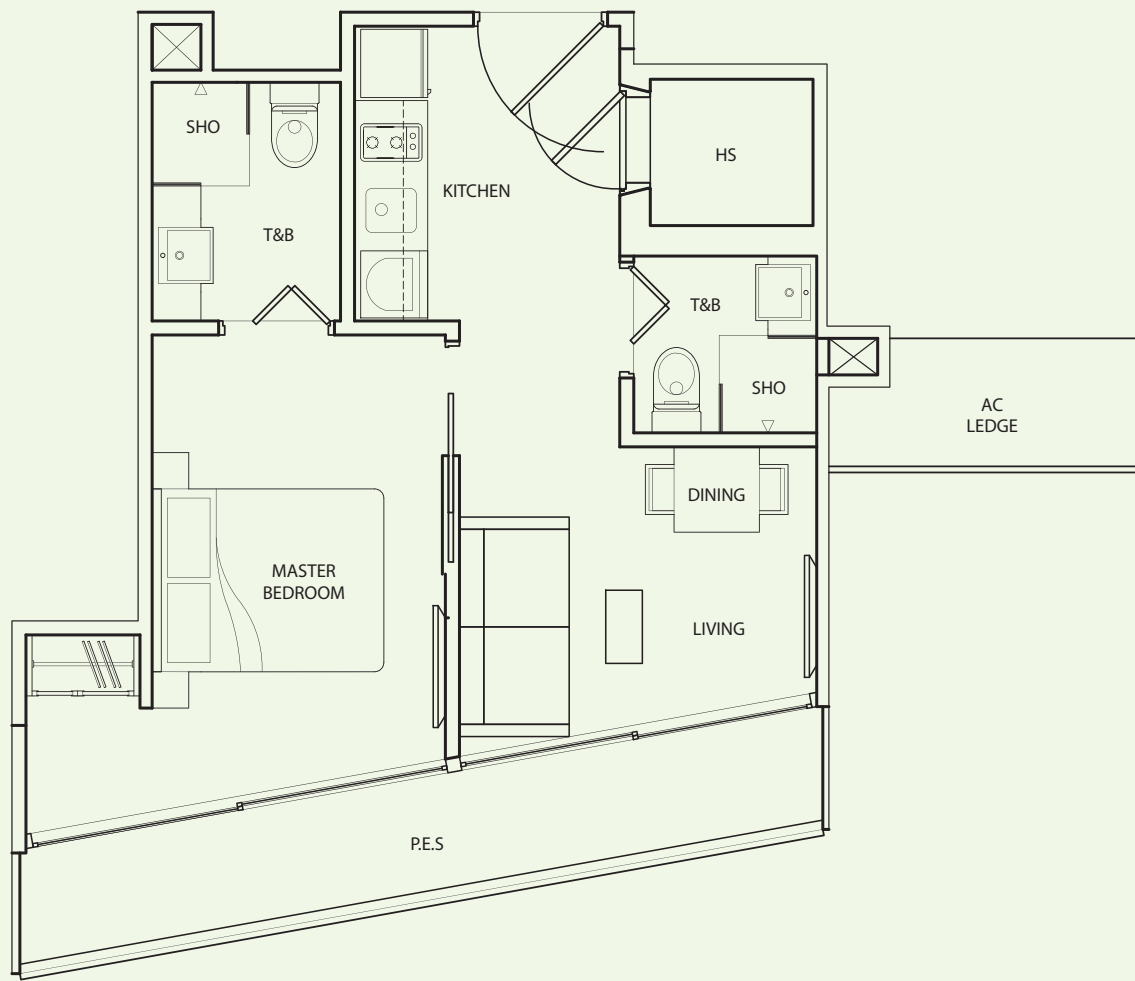

TYPE **B-1B**

1 Bedroom  
+ 2 Bathroom  
49 sq m / 527 sq ft

#01-11

Inclusive of PES, AC Ledge

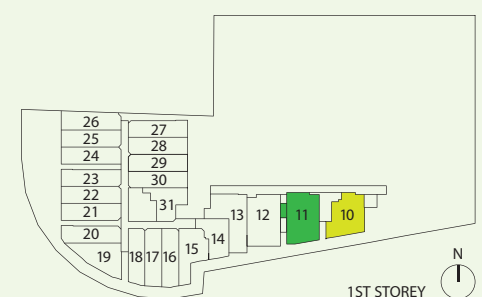
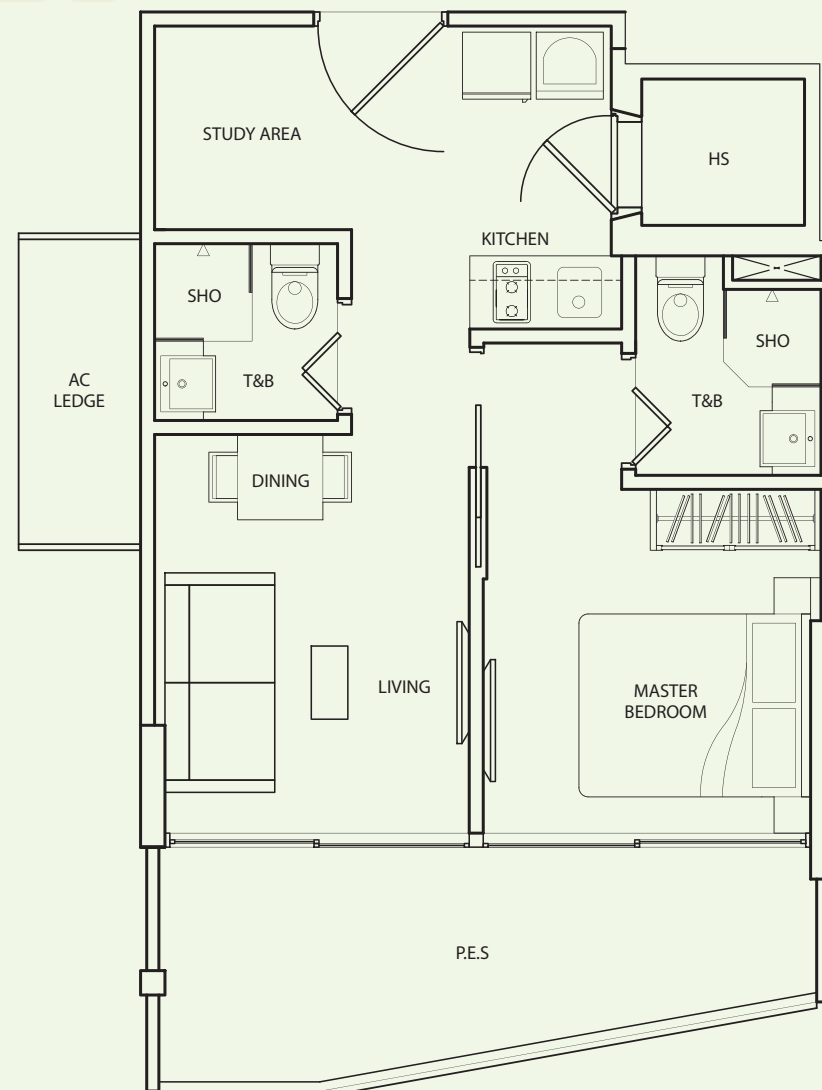

TYPE **A-1C**

1 Bedroom  
+ 2 Bathroom  
52 sq m / 560 sq ft

#01-12

Inclusive of PES, AC Ledge

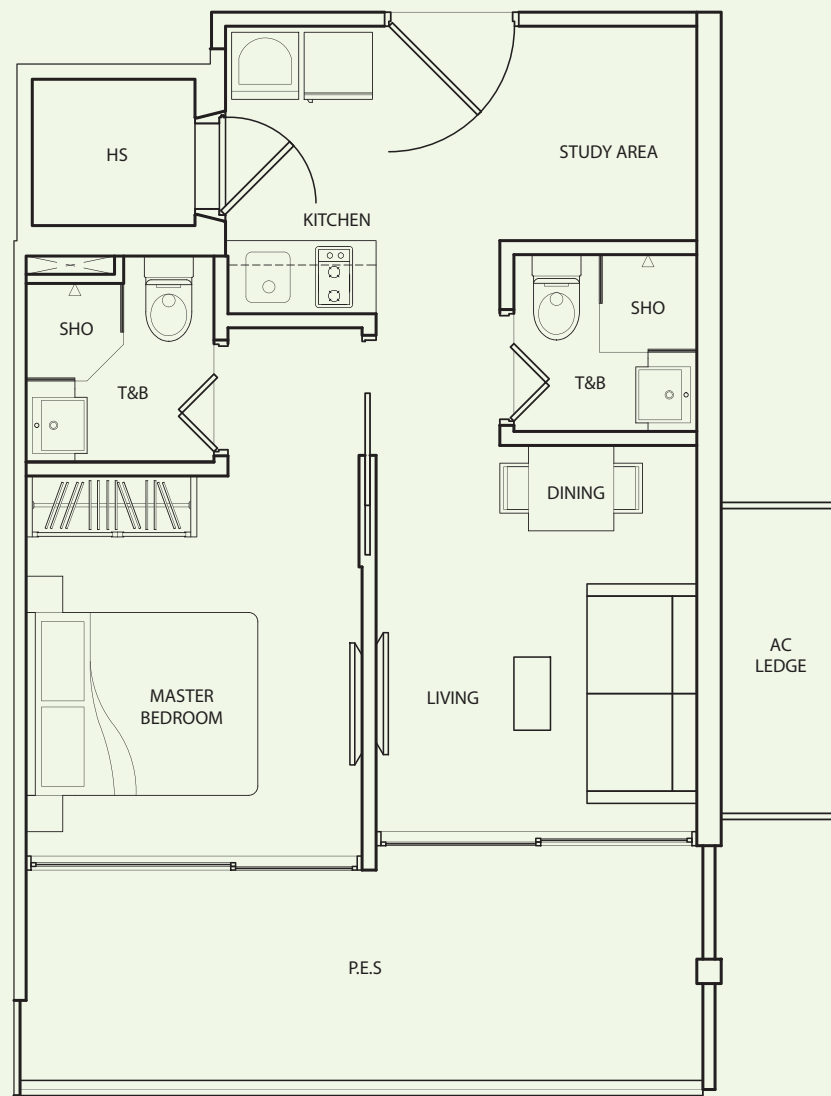

TYPE **B-1D**

1 Bedroom  
+ 2 Bathroom  
47 sq m / 506 sq ft

#01-13

Inclusive of PES, AC Ledge

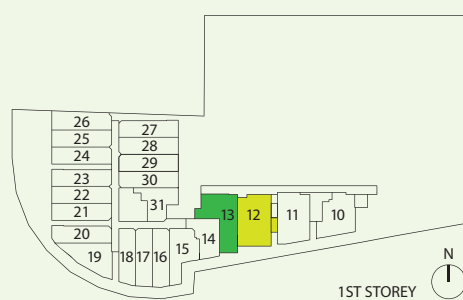

1ST STOREY

TYPE B-2A

1 Bedroom  
+ 2 Bathroom  
53 sq m / 570 sq ft

#02-01

Inclusive of PES, AC Ledge

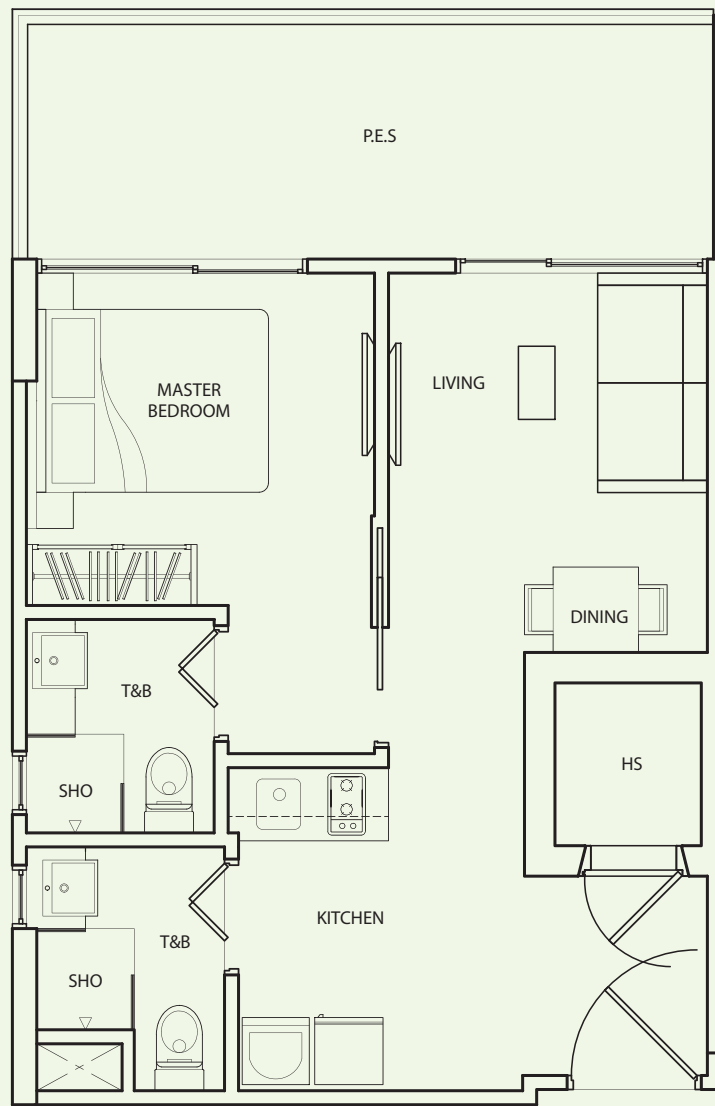

TYPE B-2B

1 Bedroom  
+ 2 Bathroom  
50 sq m / 538 sq ft

#02-02

Inclusive of PES, AC Ledge

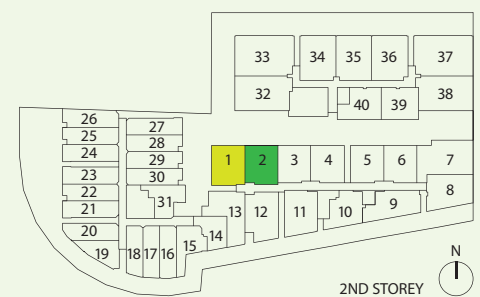
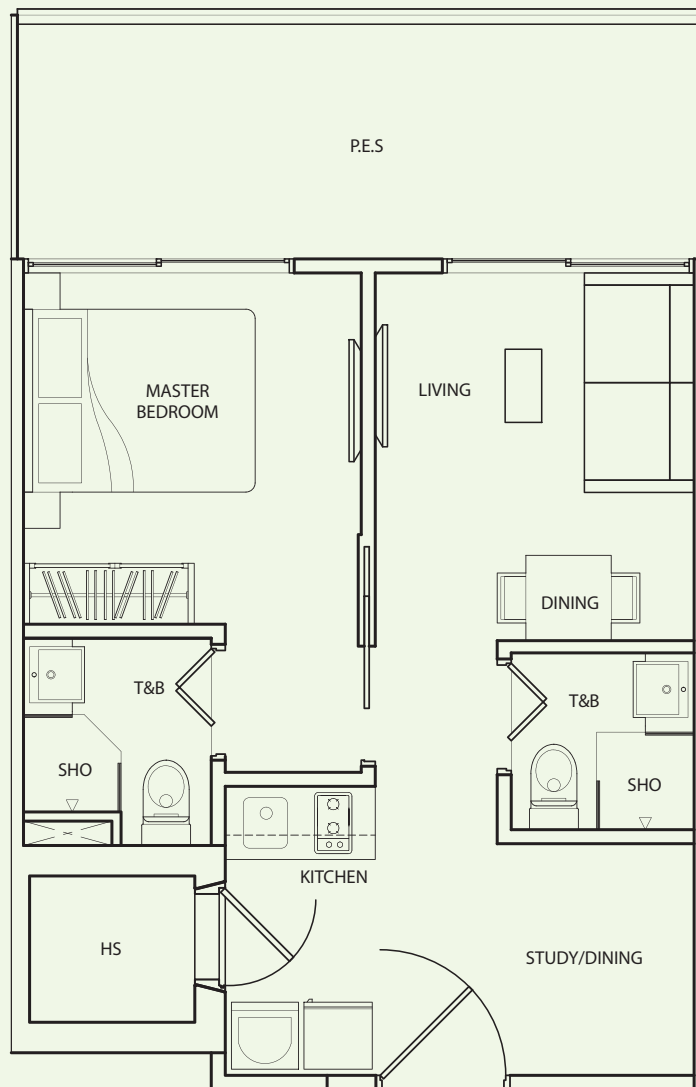

TYPE B-2C

1 Bedroom  
+ 2 Bathroom  
49 sq m / 527 sq ft

#02-03

Inclusive of PES, AC Ledge

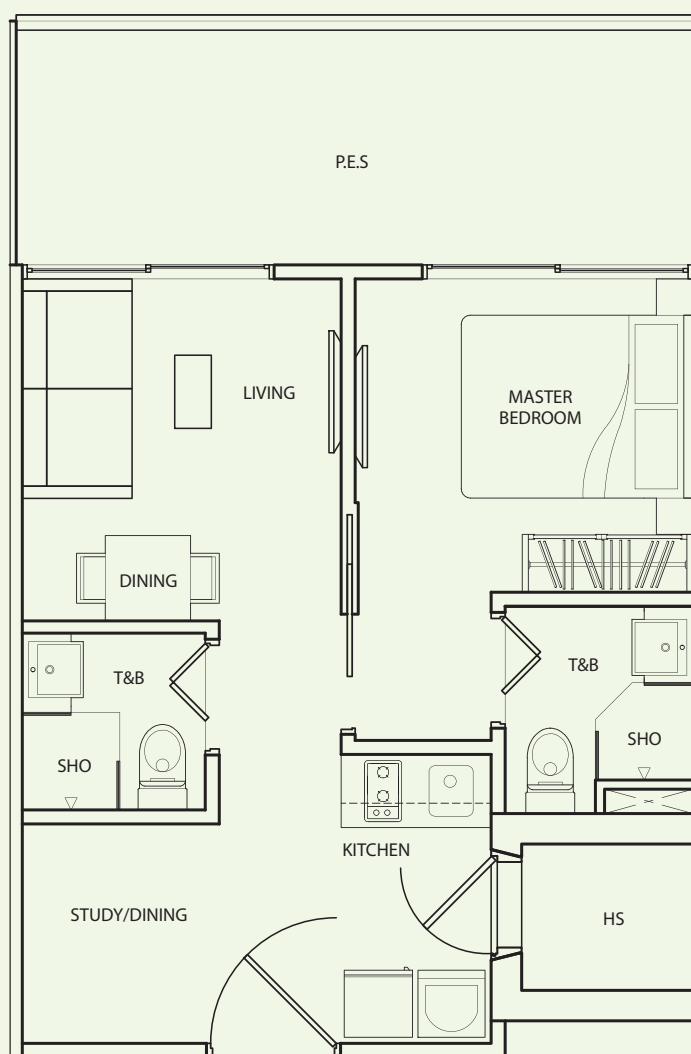

TYPE B-2D

1 Bedroom  
+ 2 Bathroom  
49 sq m / 527 sq ft

#02-04

Inclusive of PES, AC Ledge

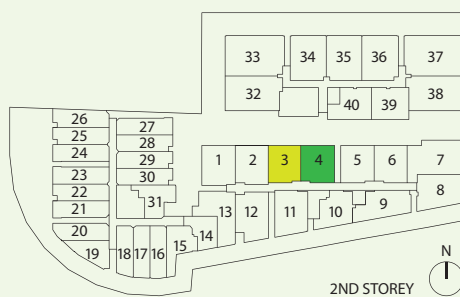
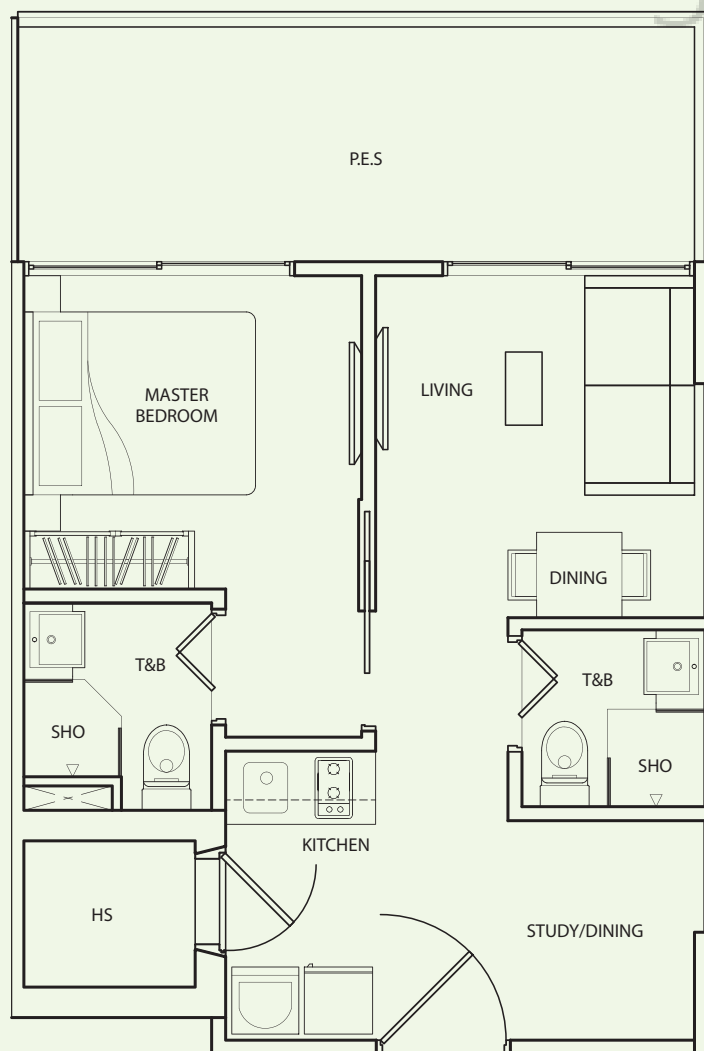

TYPE B-2C

1 Bedroom  
+ 2 Bathroom  
49 sq m / 527 sq ft

#02-05

Inclusive of PES, AC Ledge

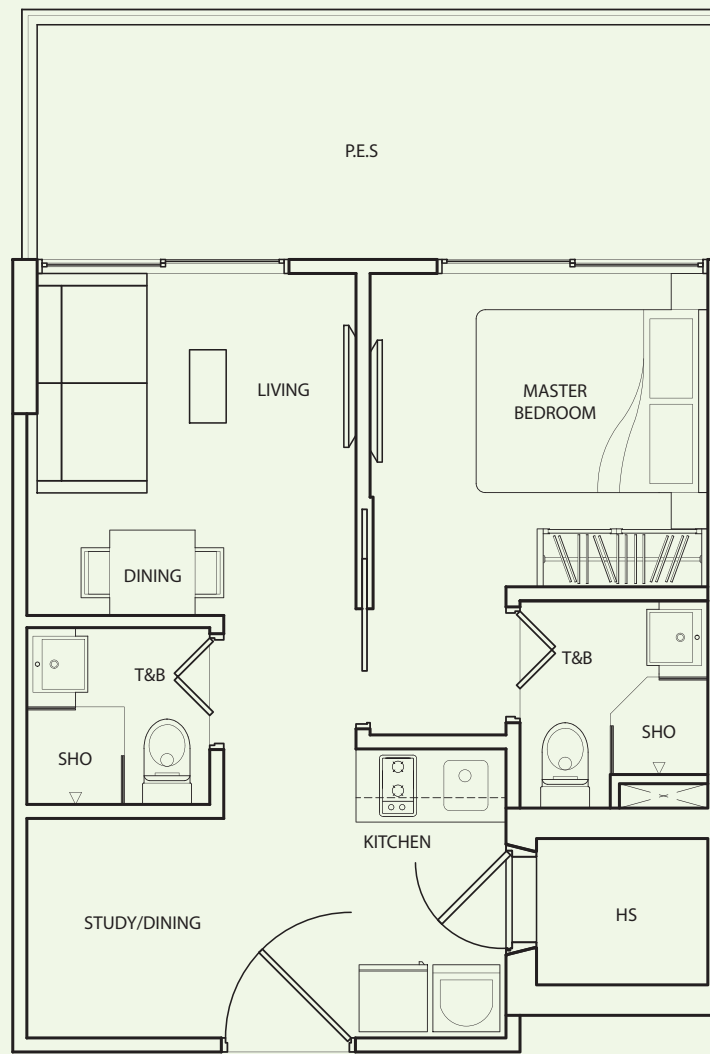

TYPE B-2D

1 Bedroom  
+ 2 Bathroom  
49 sq m / 527 sq ft

#02-06

Inclusive of PES, AC Ledge

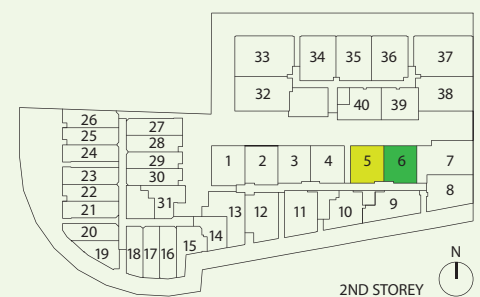
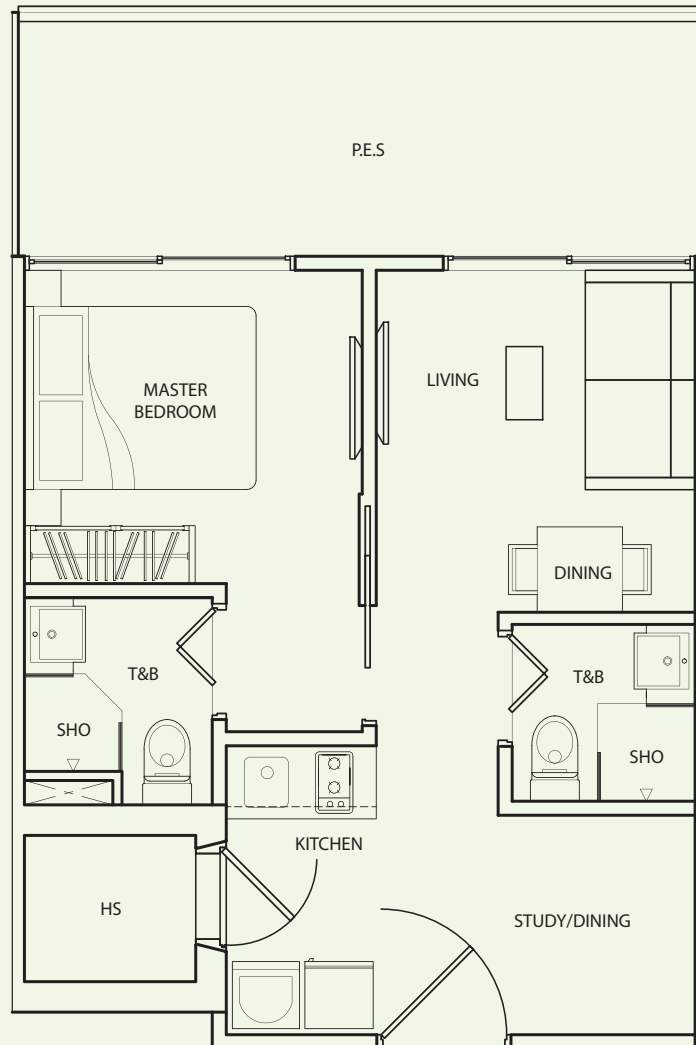

TYPE B-2E

2 Bedroom  
+ 2 Bathroom  
+ Study Room  
71 sq m / 764 sq ft

#02-07

Inclusive of PES, AC Ledge

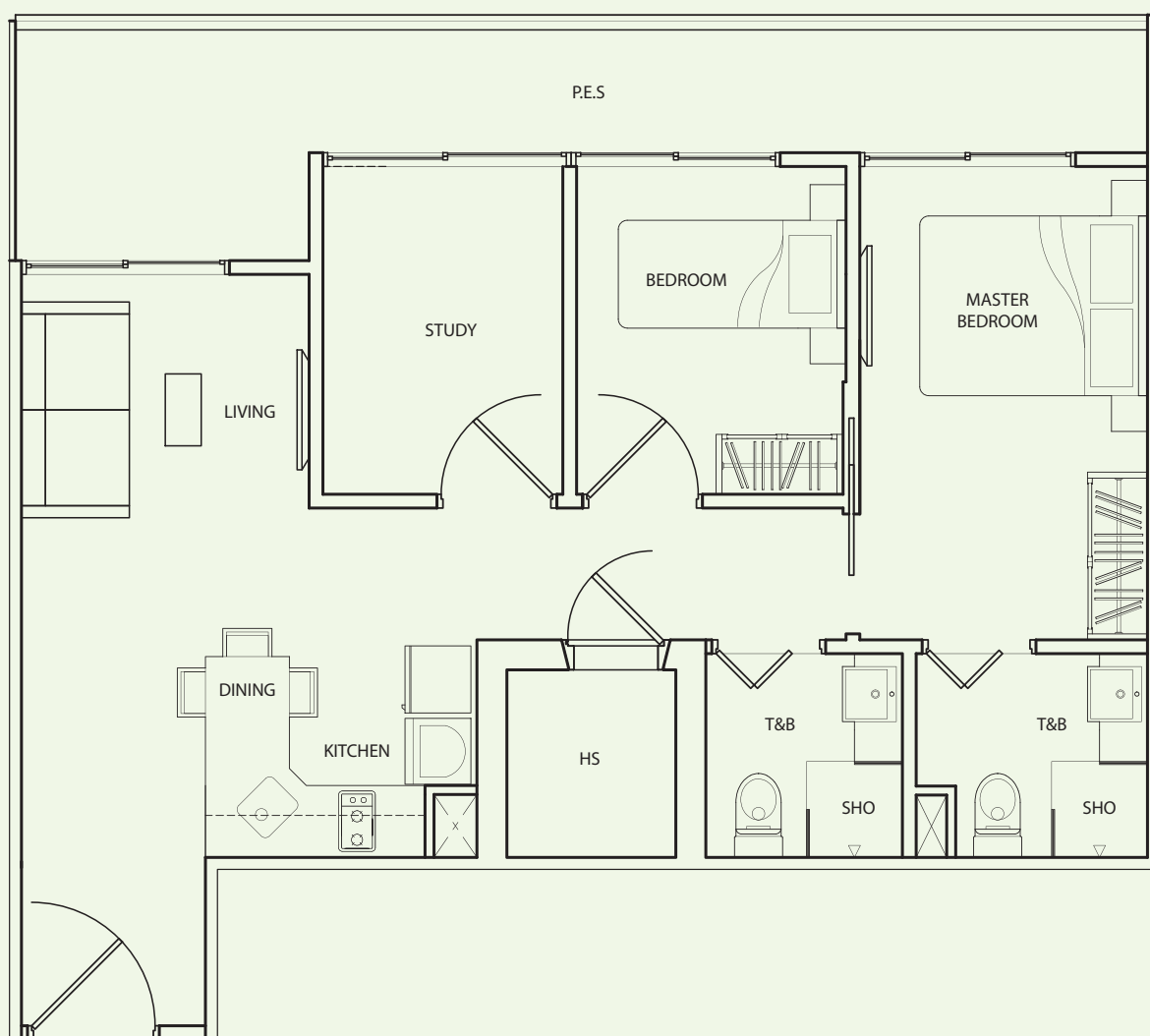

AC LEDGE  
ABOVE  
ATTIC ROOF



TYPE B-2F

2 Bedroom  
+ 2 Bathroom  
46 sq m / 495 sq ft

#02-08

Inclusive of AC Ledge

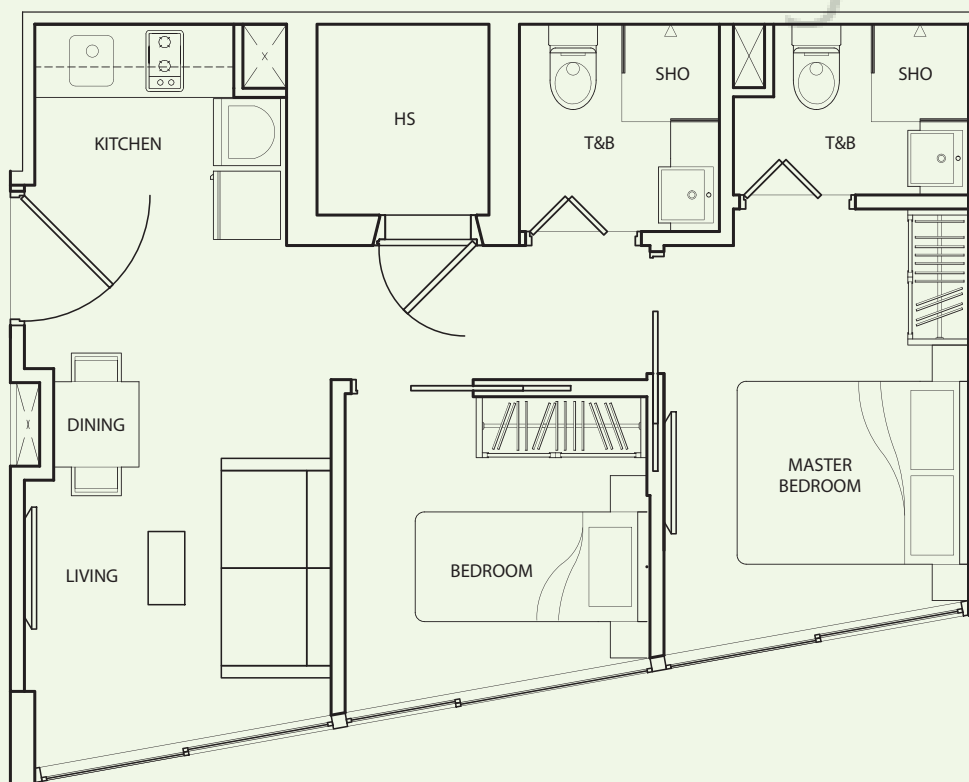

AC LEDGE  
ABOVE  
ATTIC ROOF

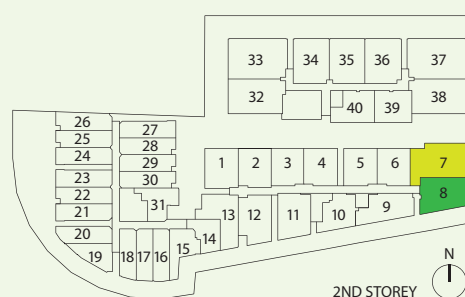

TYPE **B-2G**

2 Bedroom  
+ 2 Bathroom  
42 sq m / 452 sq ft

#02-09

Inclusive of AC Ledge

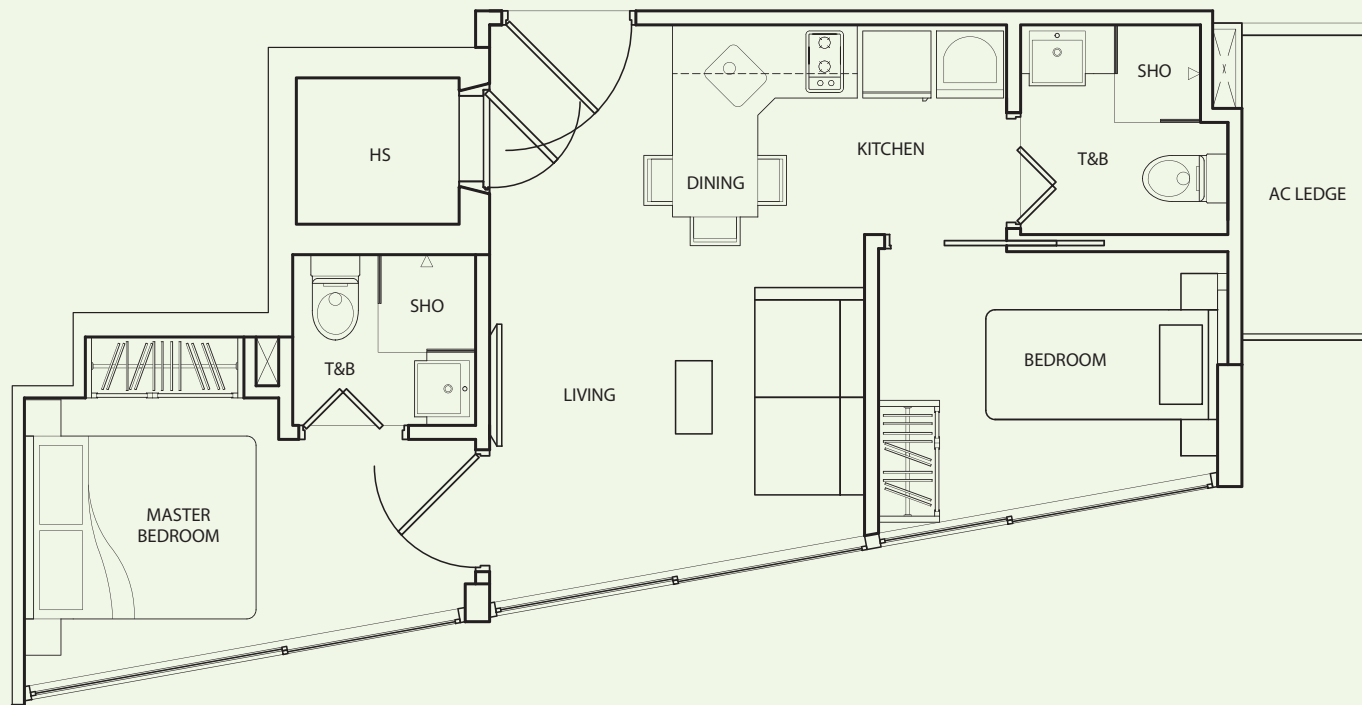

TYPE **B-2H**

1 Bedroom  
+ 2 Bathroom  
35 sq m / 377 sq ft

#02-10

Inclusive of AC Ledge

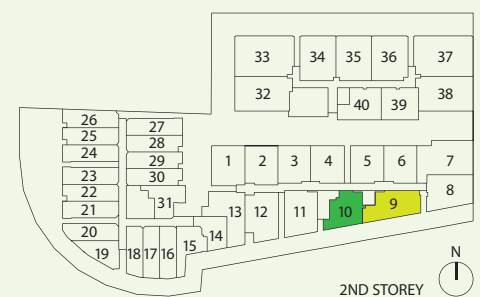
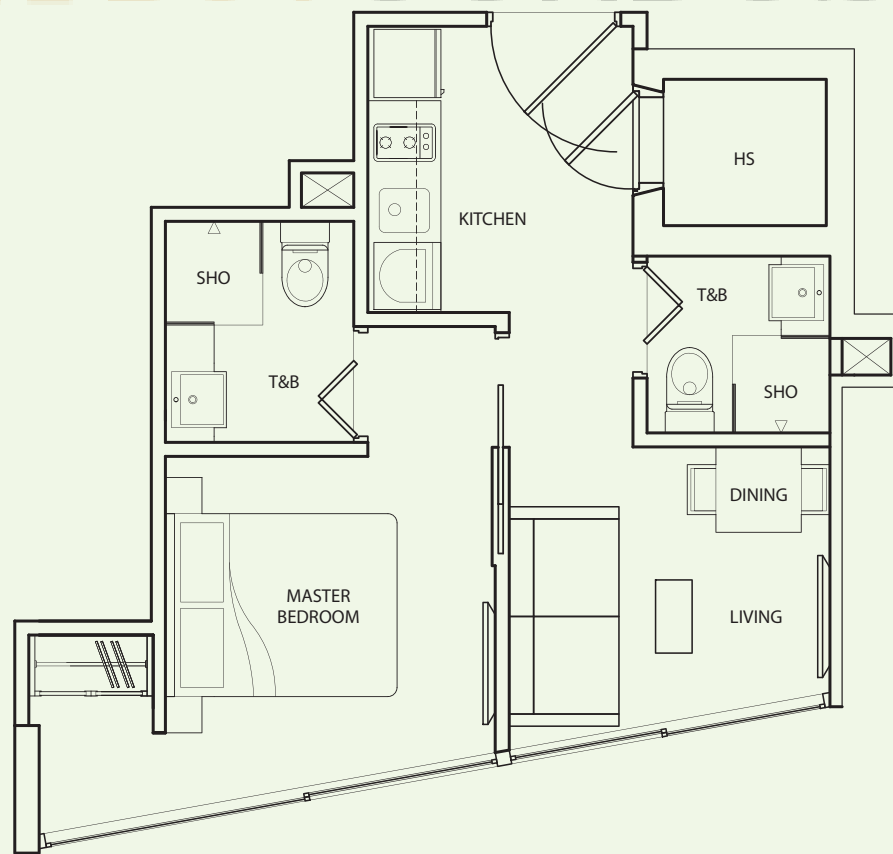

TYPE **B-2I**

1 Bedroom  
+ 2 Bathroom  
43 sq m / 463 sq ft

#02-11

Inclusive of Balcony, AC Ledge

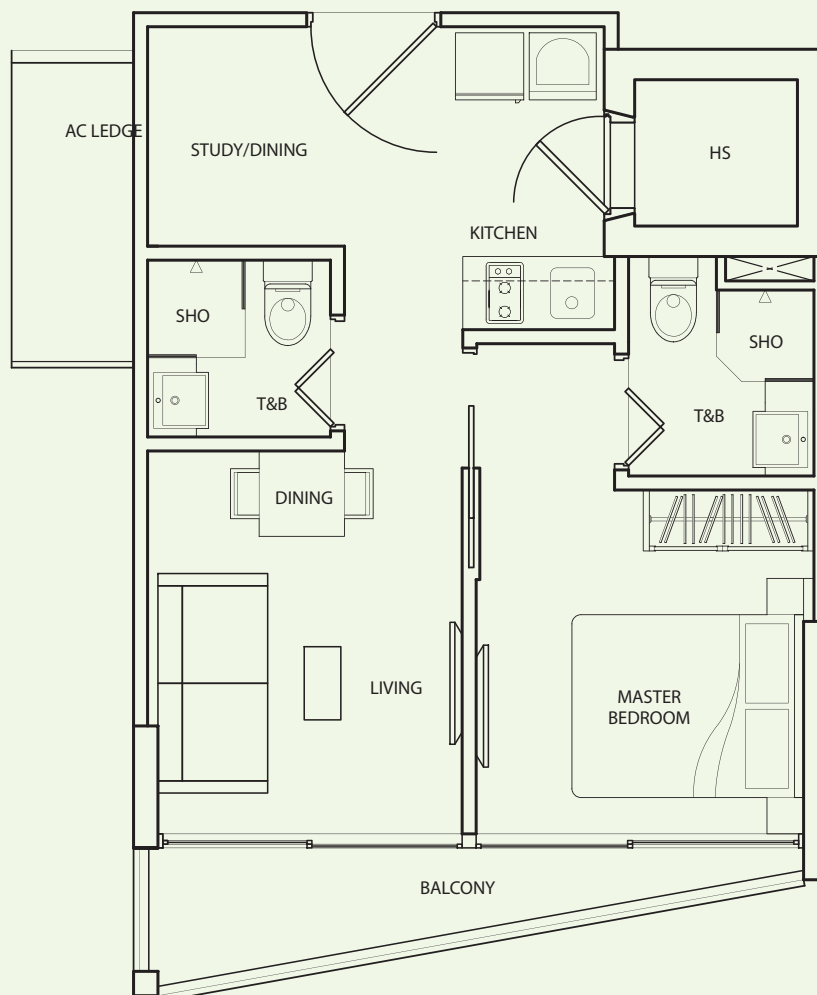

TYPE **B-2J**

1 Bedroom  
+ 2 Bathroom  
46 sq m / 495 sq ft

#02-12

Inclusive of Balcony, AC Ledge

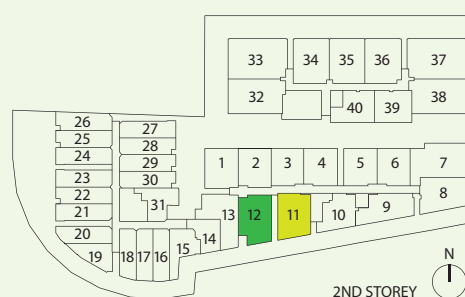
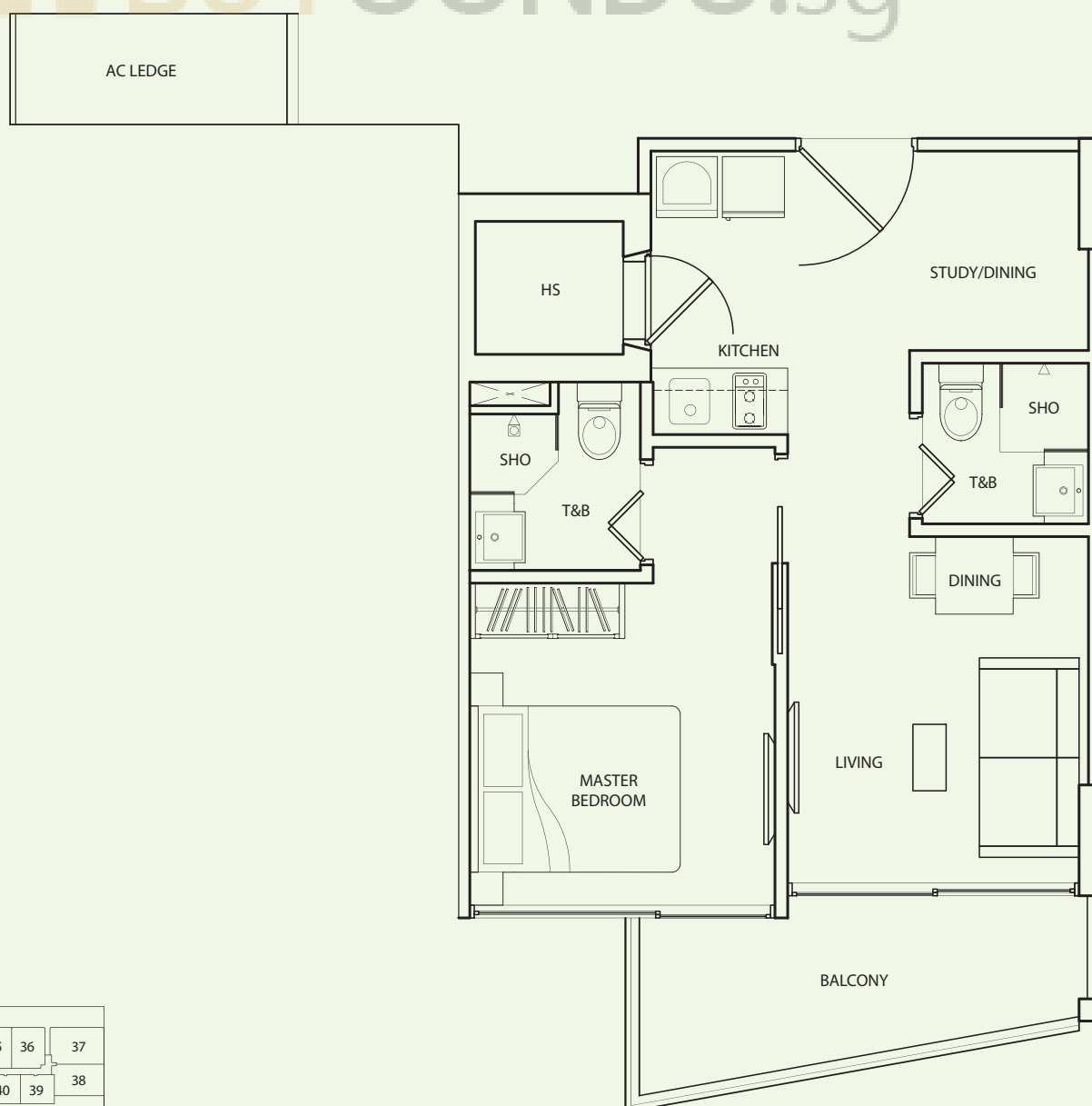



TYPE B-2K

1 Bedroom  
+ 2 Bathroom  
45 sq m / 484 sq ft

#02-13

Inclusive of AC Ledge

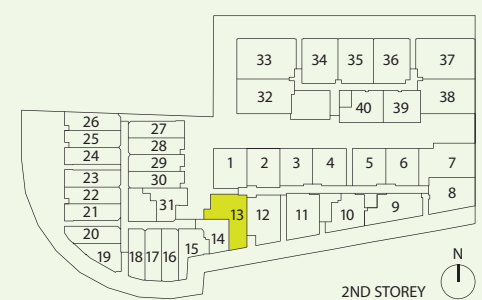
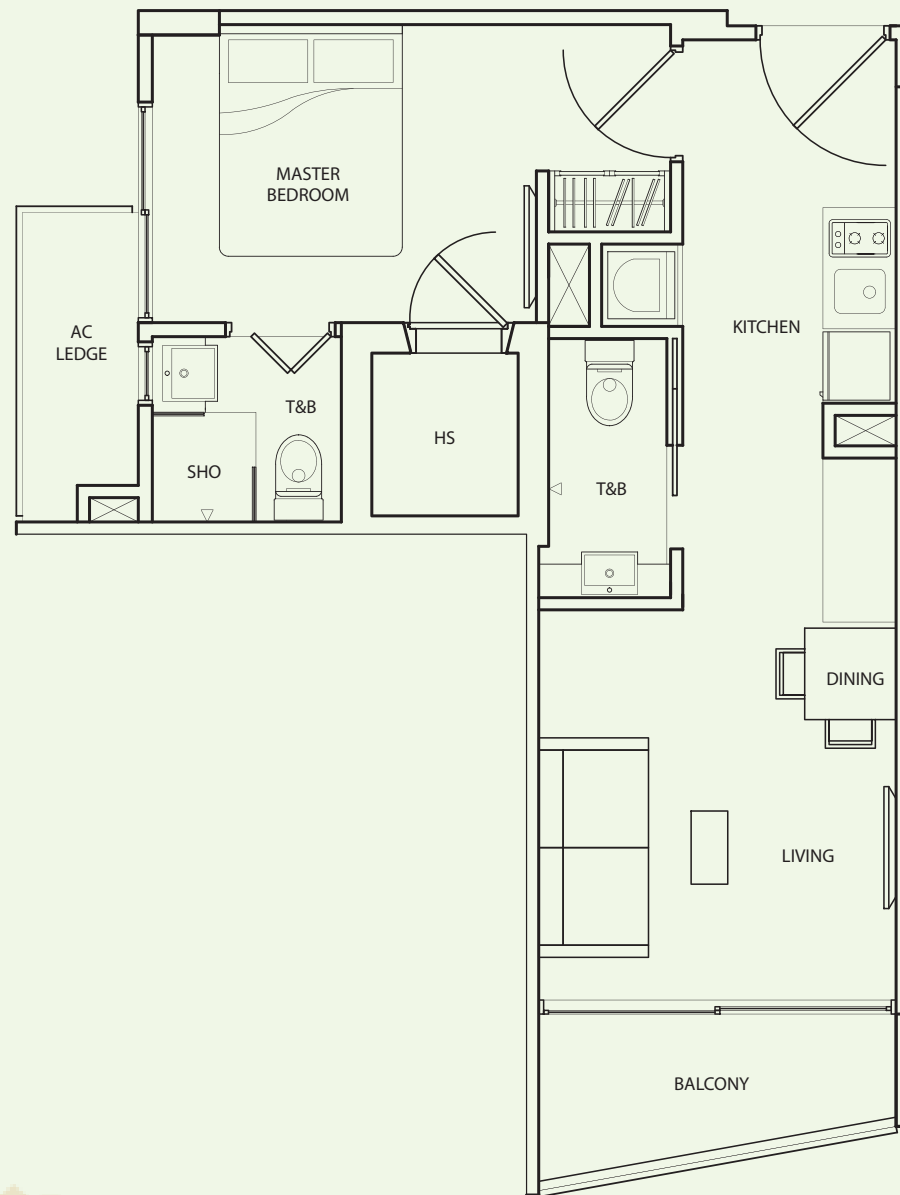

TYPE **B-3A**

1 Bedroom  
+ 2 Bathroom  
41 sq m / 441 sq ft

#03-01  
#04-01

Inclusive of AC Ledge

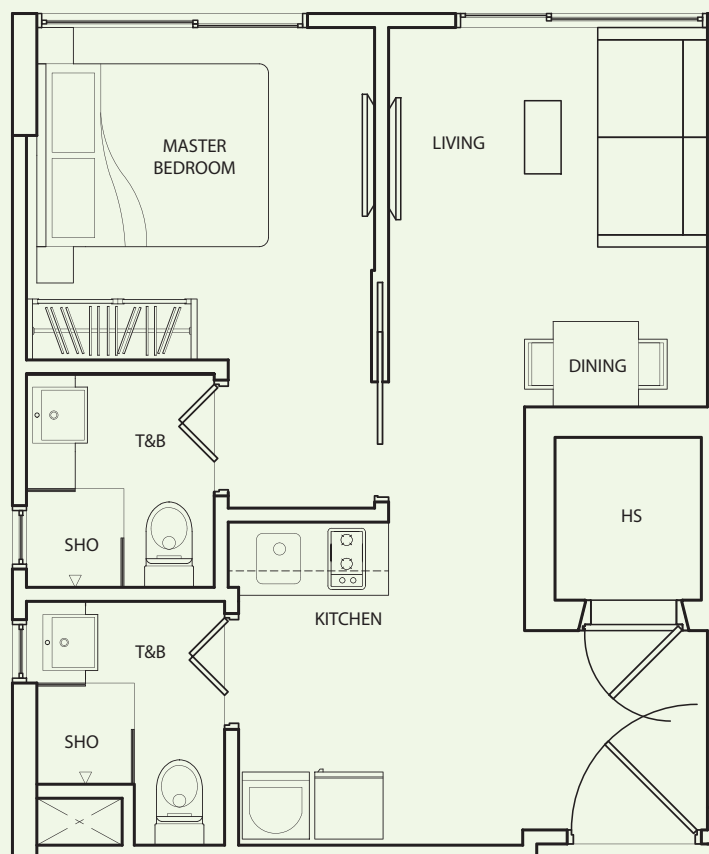

TYPE **B-3B**

1 Bedroom  
+ 2 Bathroom  
38 sq m / 409 sq ft

#03-02  
#04-02

Inclusive of AC Ledge

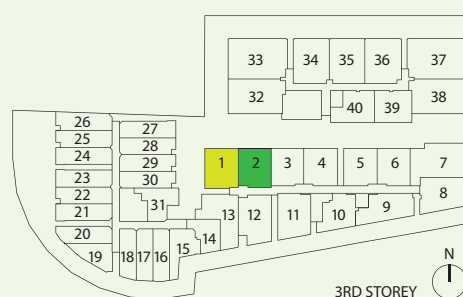
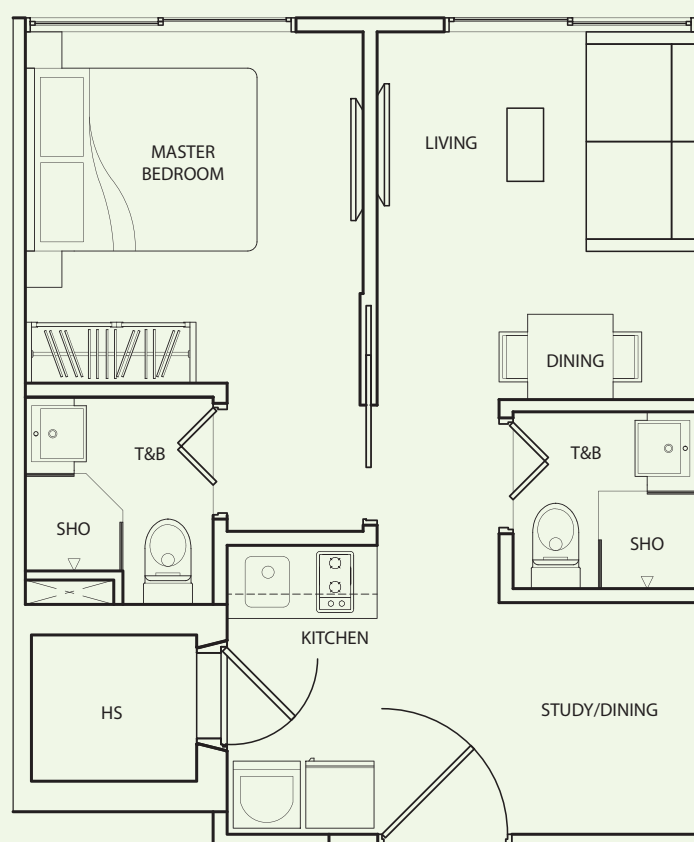

TYPE B-3C

1 Bedroom  
+ 2 Bathroom  
37 sq m / 398 sq ft

#03-03  
#04-03

Inclusive of AC Ledge

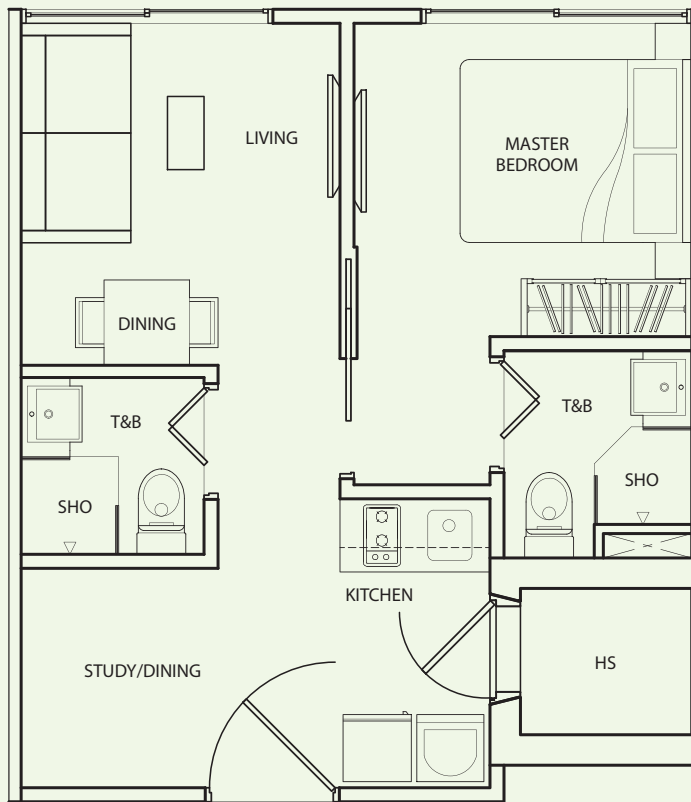

TYPE B-3D

1 Bedroom  
+ 2 Bathroom  
37 sq m / 398 sq ft

#03-04  
#04-04

Inclusive of AC Ledge

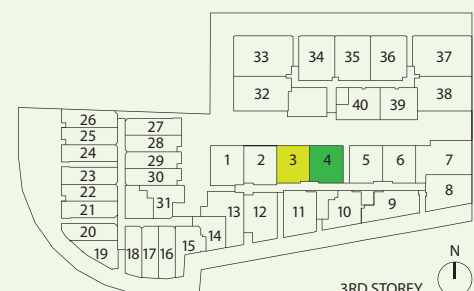
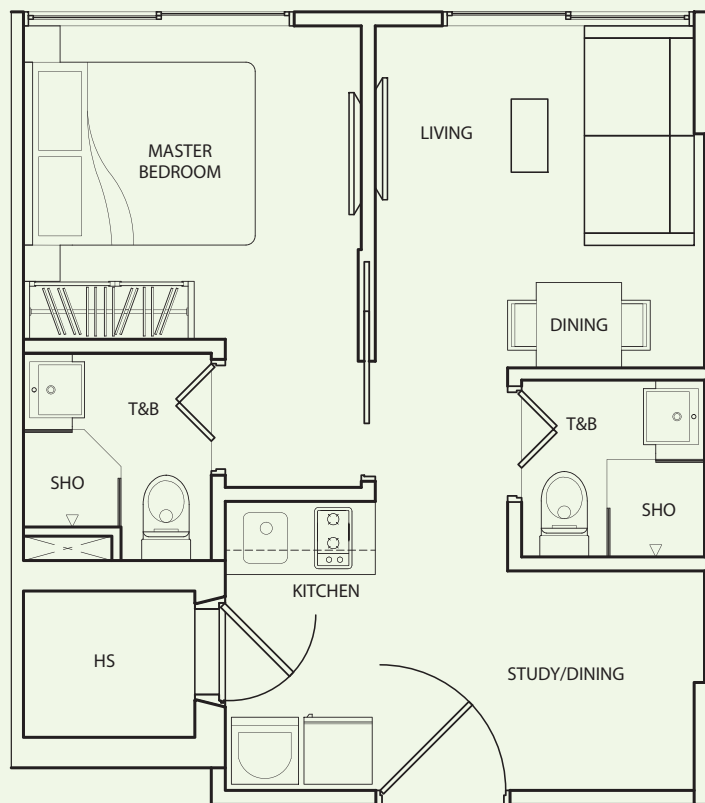

3RD STOREY

TYPE B-3C

1 Bedroom  
+ 2 Bathroom  
37 sq m / 398 sq ft

#03-05  
#04-05

Inclusive of AC Ledge

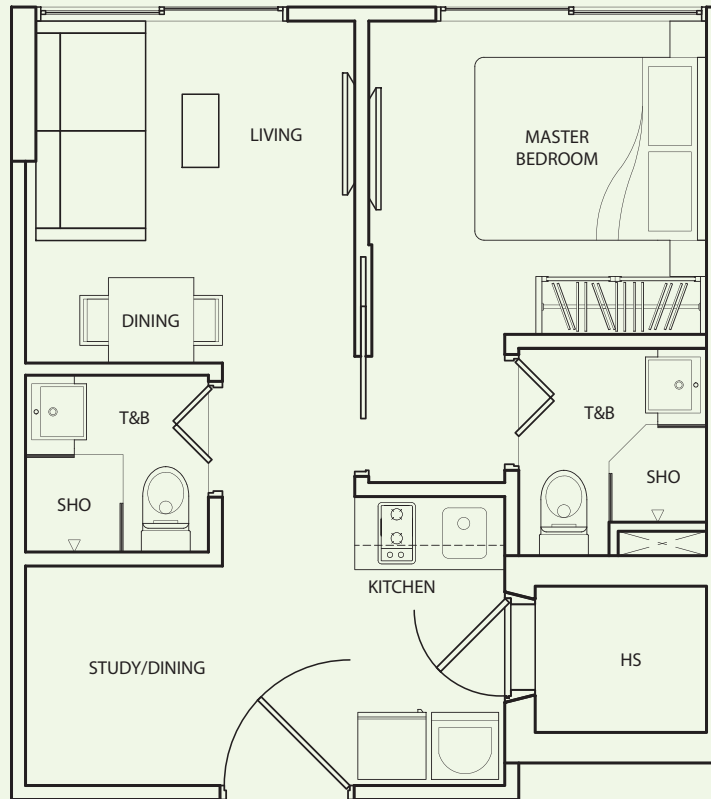

TYPE B-3D

1 Bedroom  
+ 2 Bathroom  
37 sq m / 398 sq ft

#03-06  
#04-06

Inclusive of AC Ledge

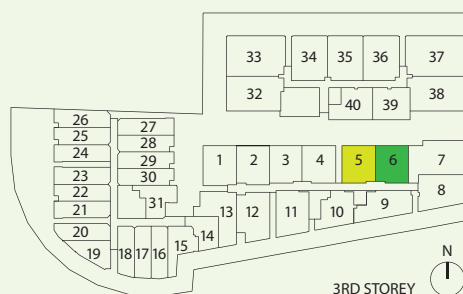
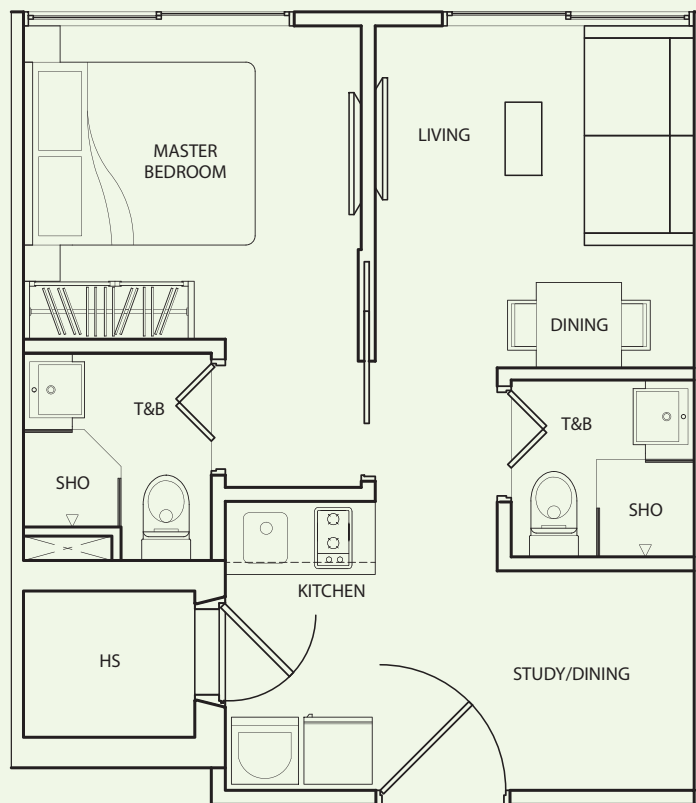

TYPE **B-3E**

2 Bedroom  
 + 2 Bathroom  
 + Study Room  
 58 sq m / 624 sq ft

#03-07

#04-07

Inclusive of AC Ledge

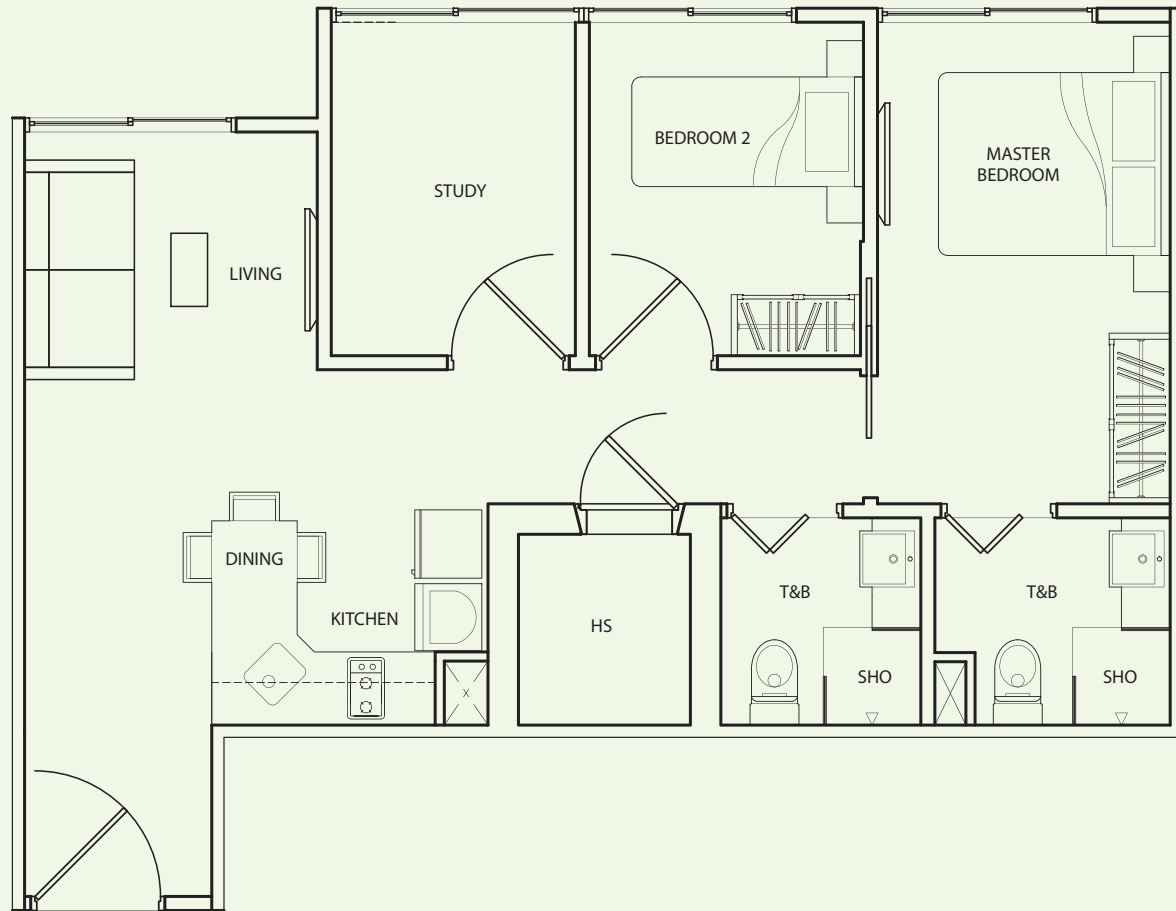

TYPE **B-2F**

2 Bedroom  
 + 2 Bathroom  
 46 sq m / 495 sq ft

#03-08

#04-08

#05-08

Inclusive of AC Ledge

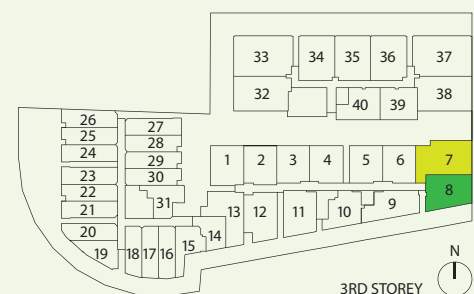
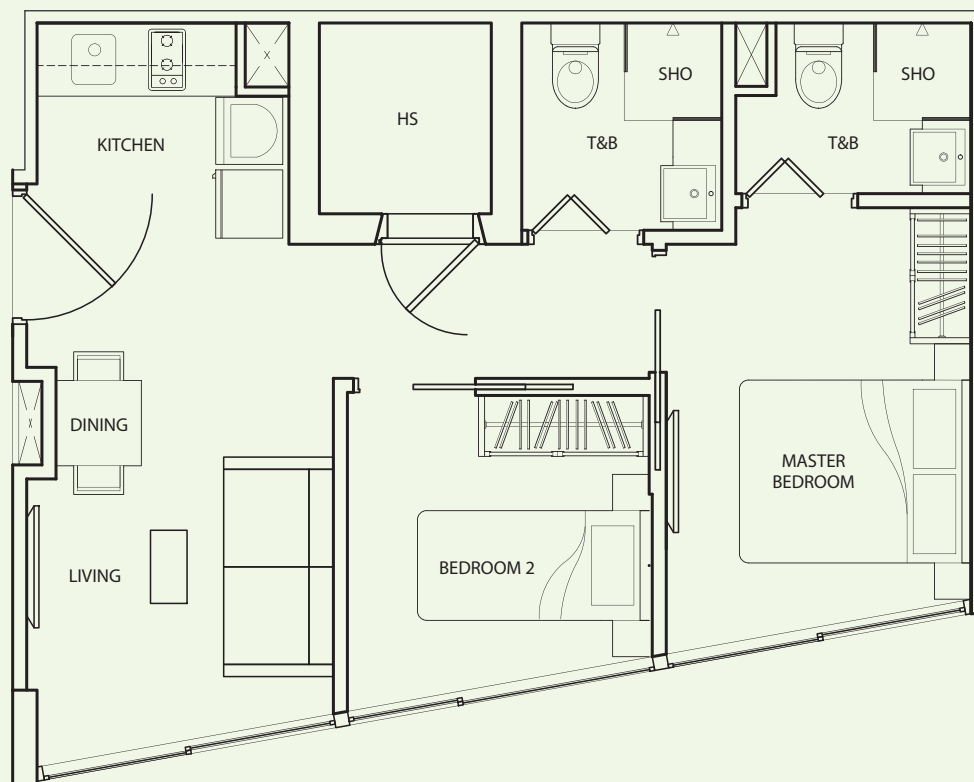

TYPE **B-2G**

2 Bedroom  
+ 2 Bathroom  
42 sq m / 452 sq ft

- #03-09
- #04-09
- #05-09

Inclusive of AC Ledge

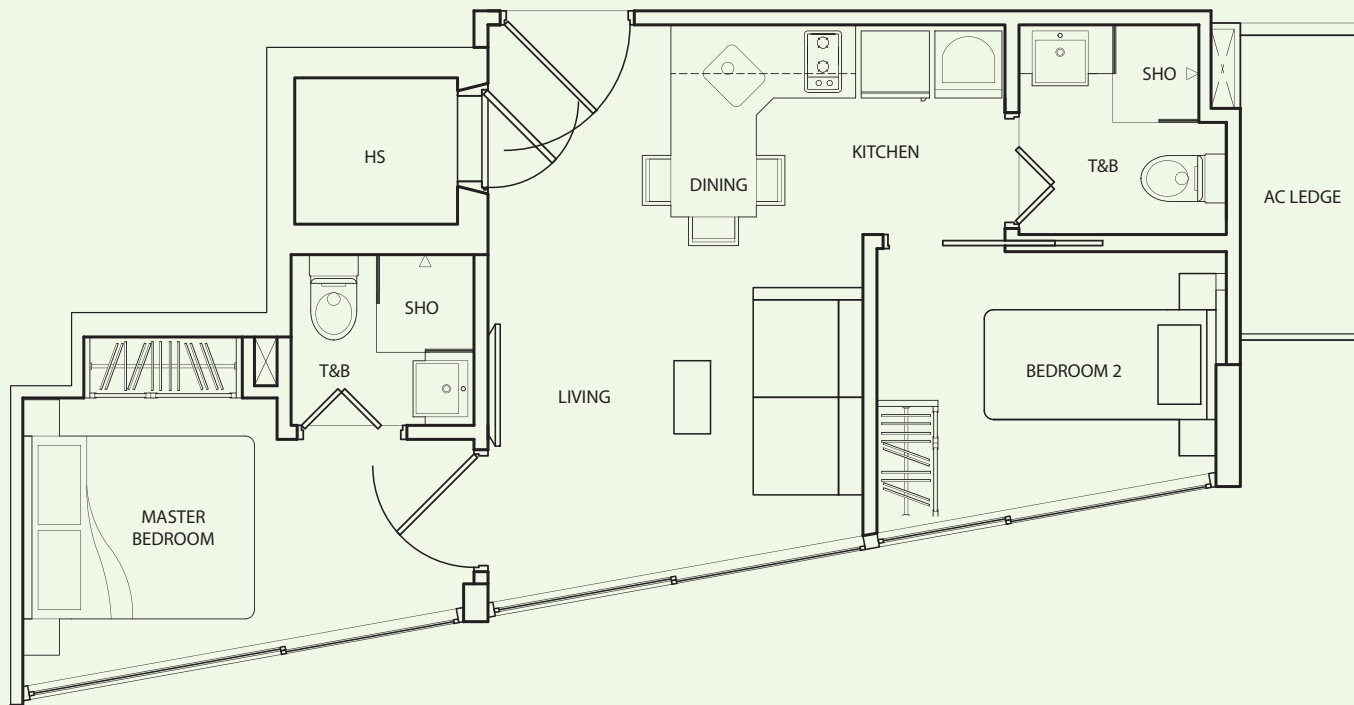

TYPE **B-2H**

1 Bedroom  
+ 2 Bathroom  
35 sq m / 377 sq ft

- #03-10
- #04-10
- #05-10

Inclusive of AC Ledge

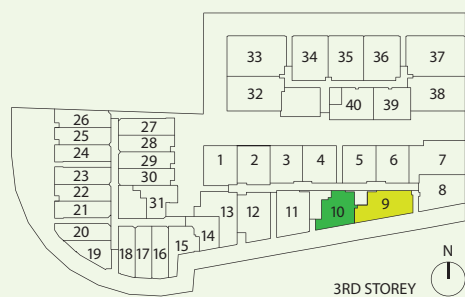
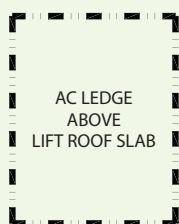
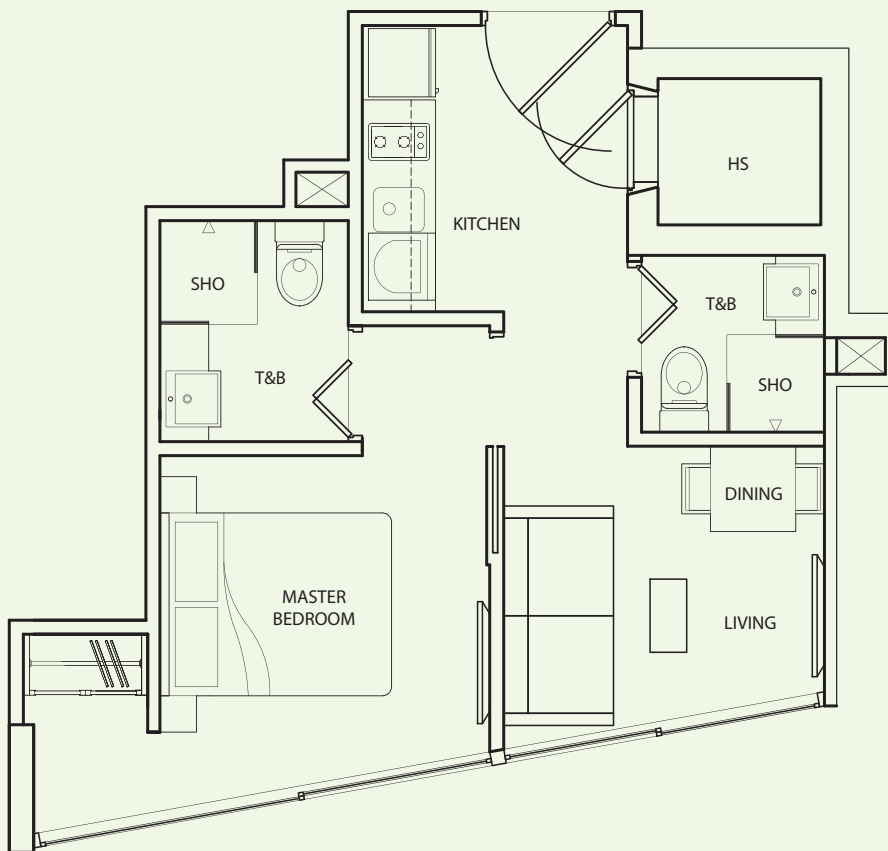

TYPE **B-2I**

1 Bedroom  
+ 2 Bathroom  
43 sq m / 463 sq ft

- #03-11
- #04-11
- #05-11

Inclusive of Balcony, AC Ledge

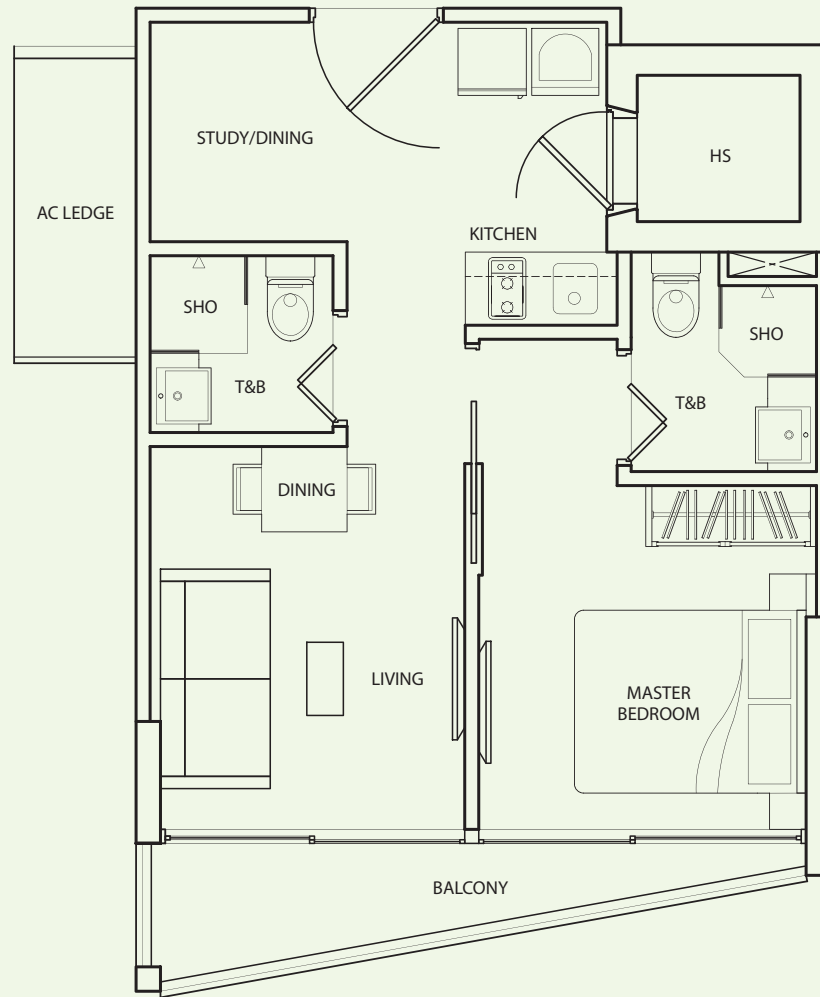

TYPE **B-2J**

1 Bedroom  
+ 2 Bathroom  
46 sq m / 495 sq ft

- #03-12
- #04-12
- #05-12

Inclusive of Balcony, AC Ledge

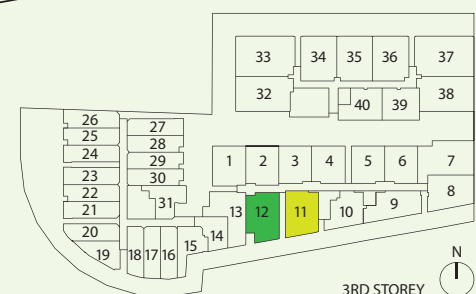
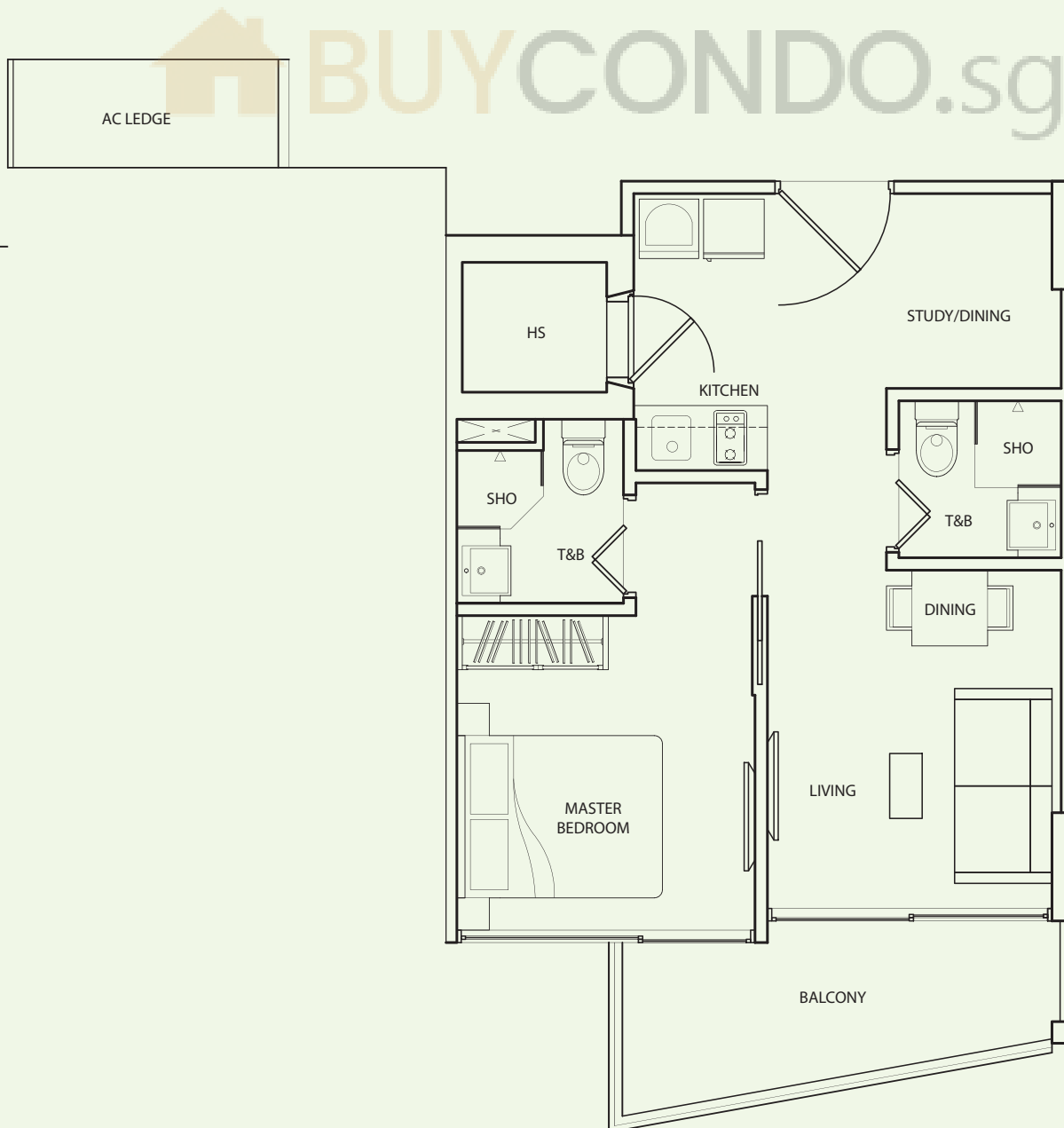

3RD STOREY

TYPE **B-2K**

1 Bedroom  
+ 2 Bathroom  
45 sq m / 484 sq ft

#03-13

#04-13

#05-13

Inclusive of Balcony, AC Ledge

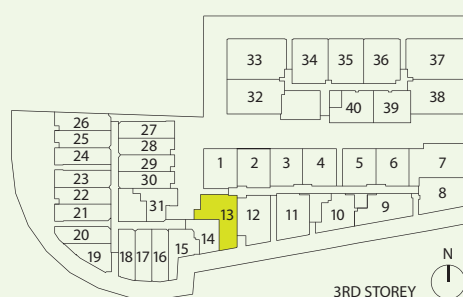
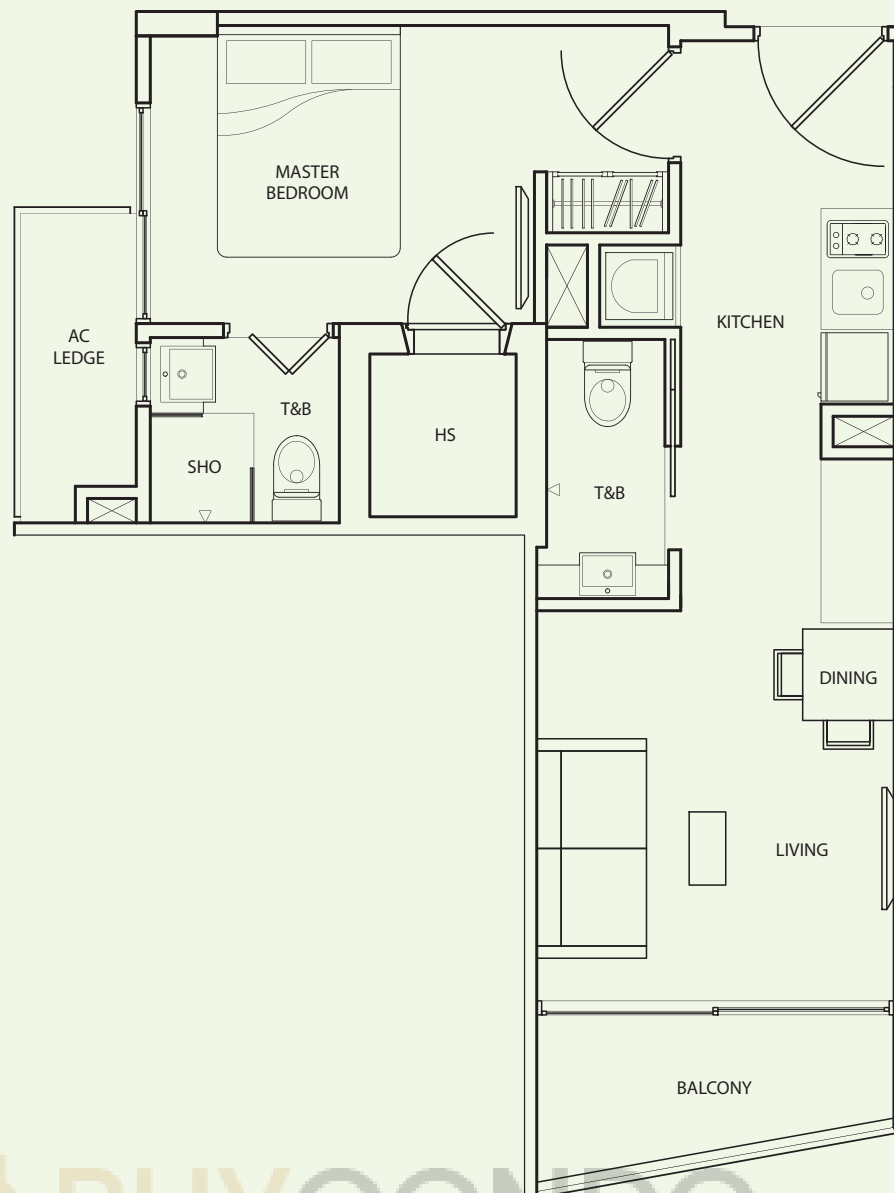



TYPE B-P5A

2 Bedroom  
+ 3 Bathroom  
74 sq m / 796 sq ft

#05-01

Inclusive of Roof Terrace,  
AC Ledge

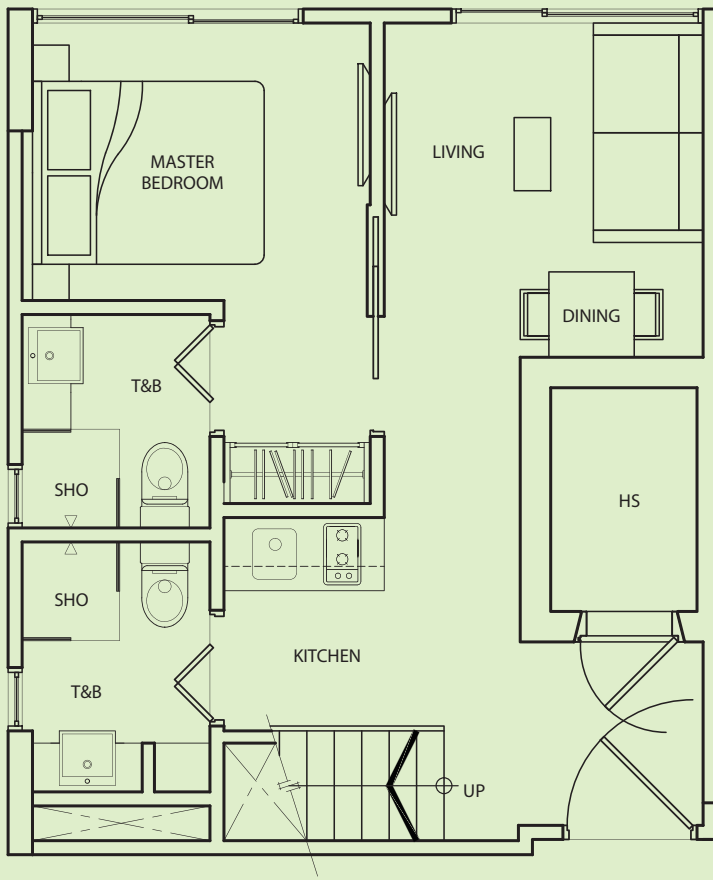

lower floor

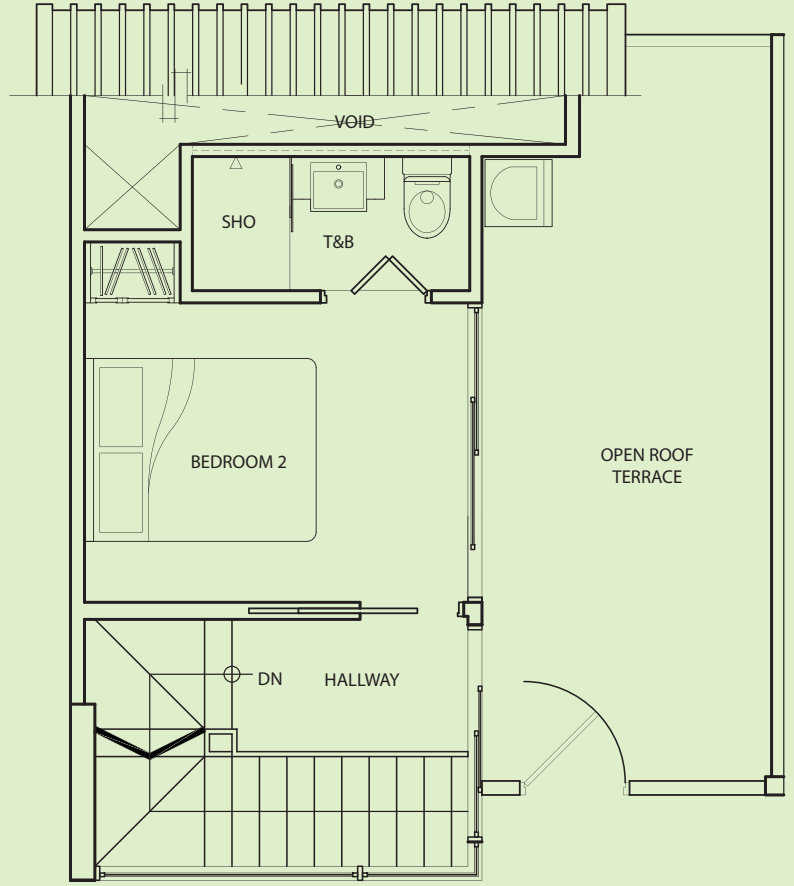

upper floor



AC LEDGE  
ABOVE  
ATTIC ROOF

TYPE B-P5B

2 Bedroom  
+ 3 Bathroom  
69 sq m / 743 sq ft

#05-02

Inclusive of Roof Terrace,  
AC Ledge

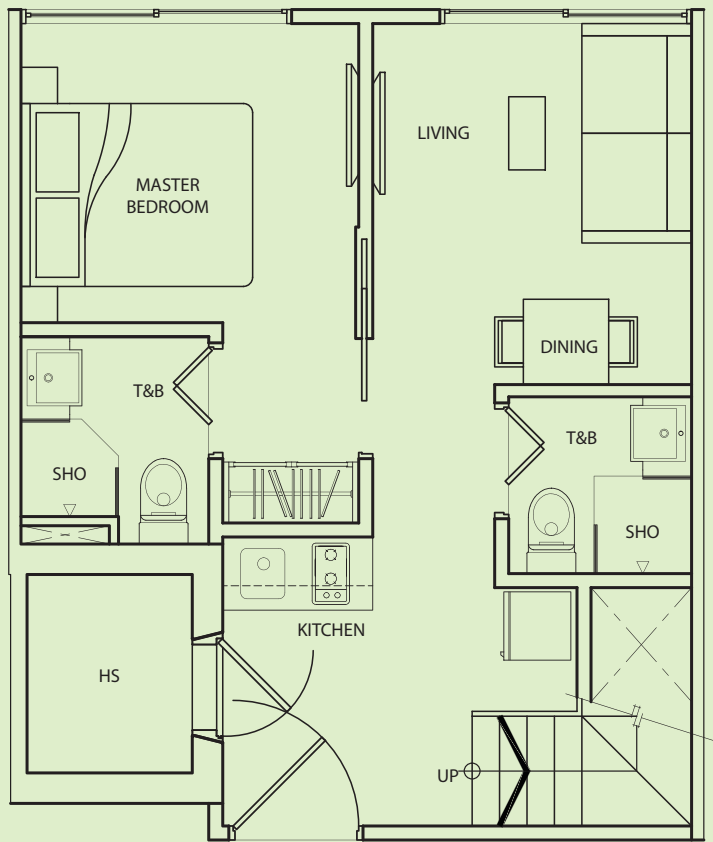

lower floor

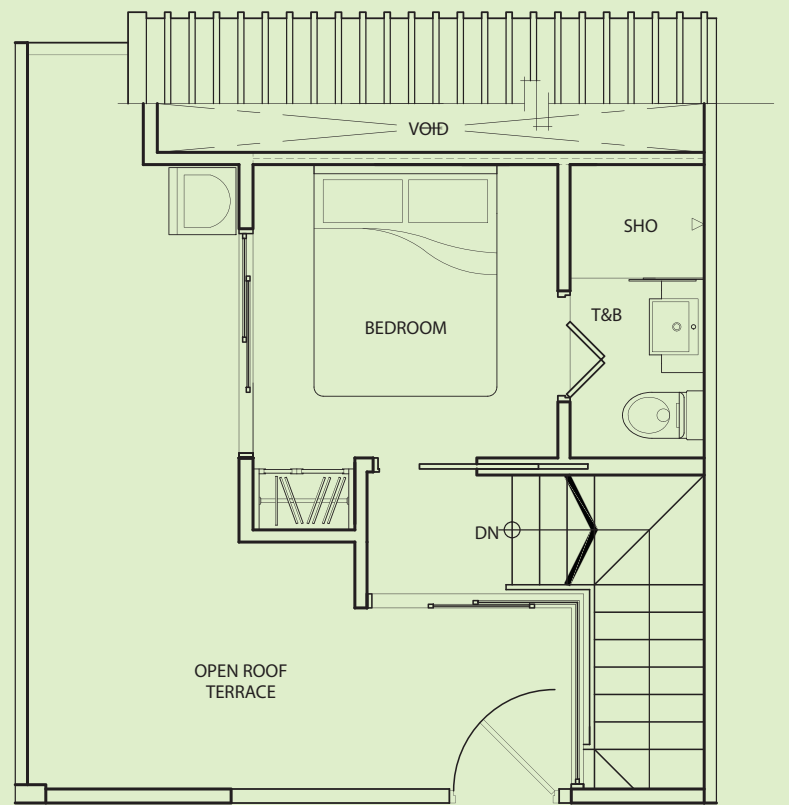

upper floor



AC LEDGE  
ABOVE  
ATTIC ROOF

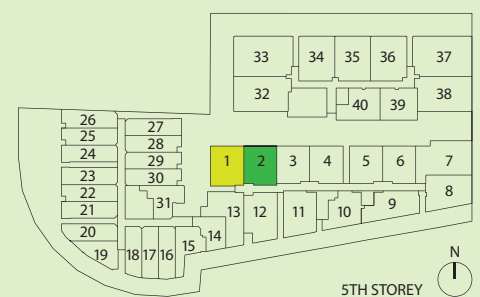

TYPE B-P5C

2 Bedroom  
+ 3 Bathroom  
66 sq m / 710 sq ft

#05-03

Inclusive of Roof Terrace,  
AC Ledge

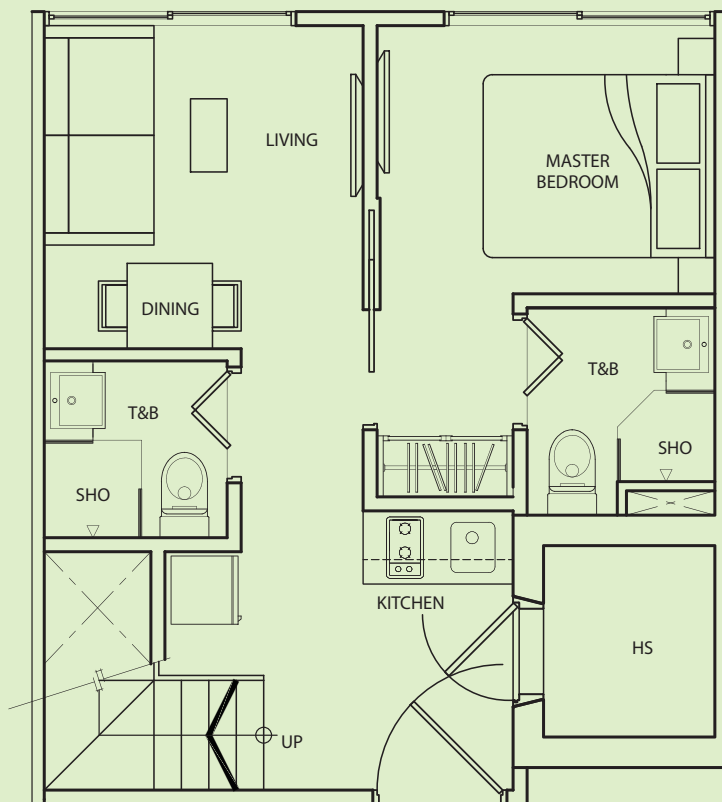

lower floor

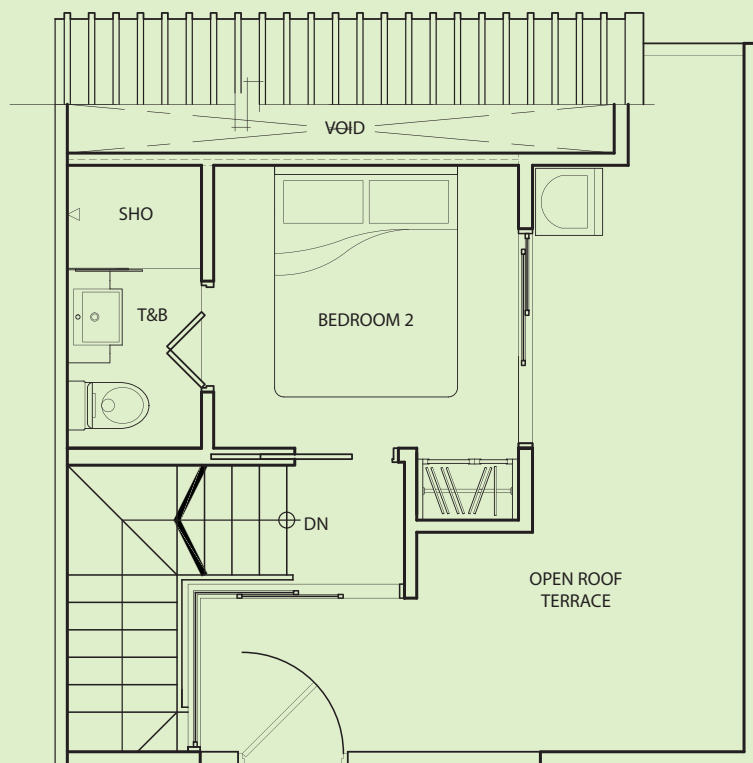

upper floor



TYPE B-P5D

2 Bedroom  
+ 3 Bathroom  
65 sq m / 700 sq ft

#05-04

Inclusive of Roof Terrace,  
AC Ledge

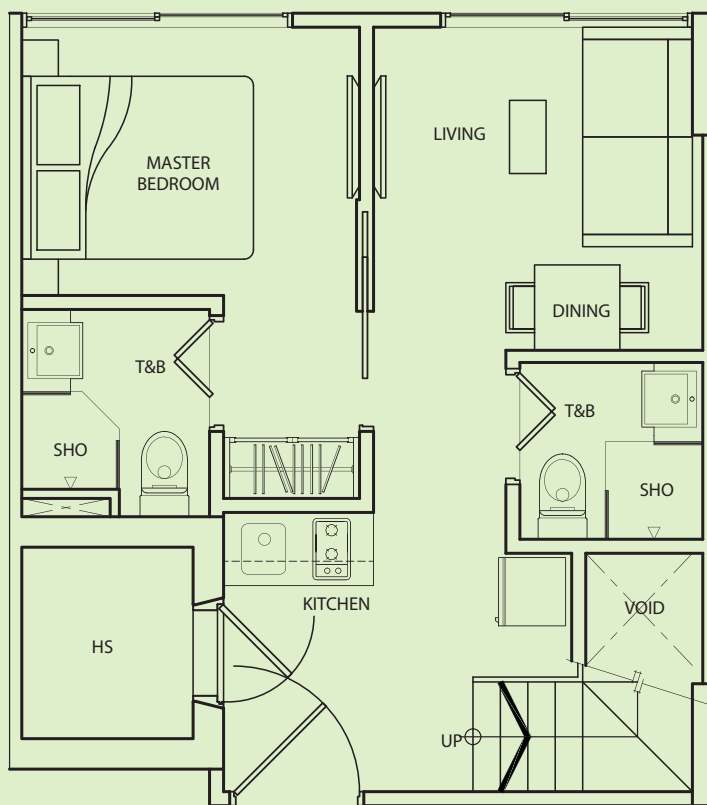

lower floor

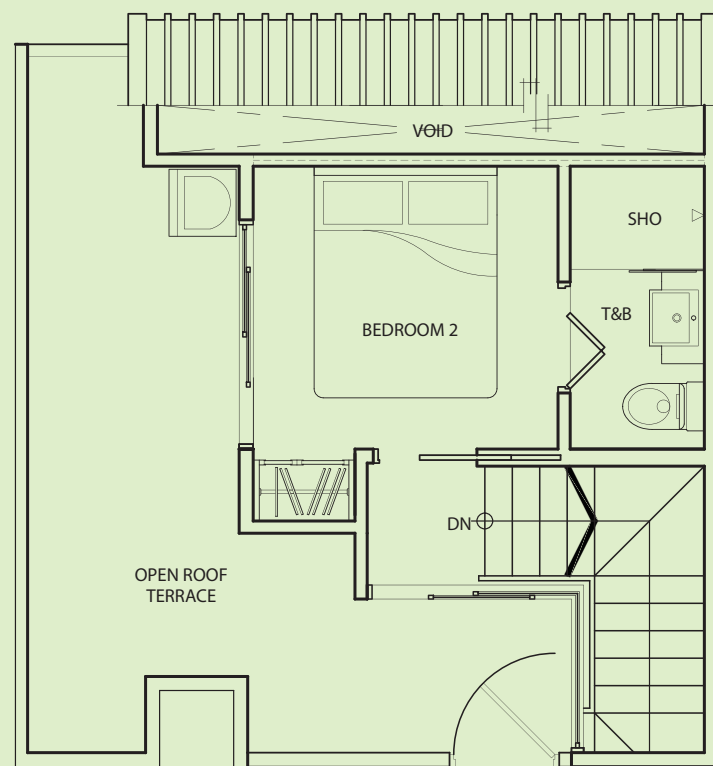

upper floor

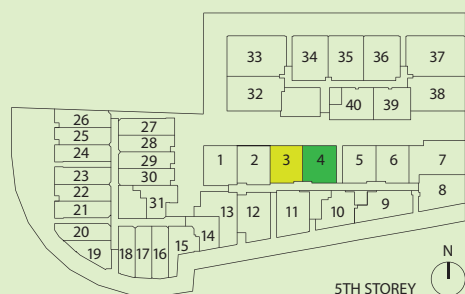

TYPE B-P5C

2 Bedroom  
+ 3 Bathroom  
66 sq m / 710 sq ft

#05-05

Inclusive of Roof Terrace,  
AC Ledge

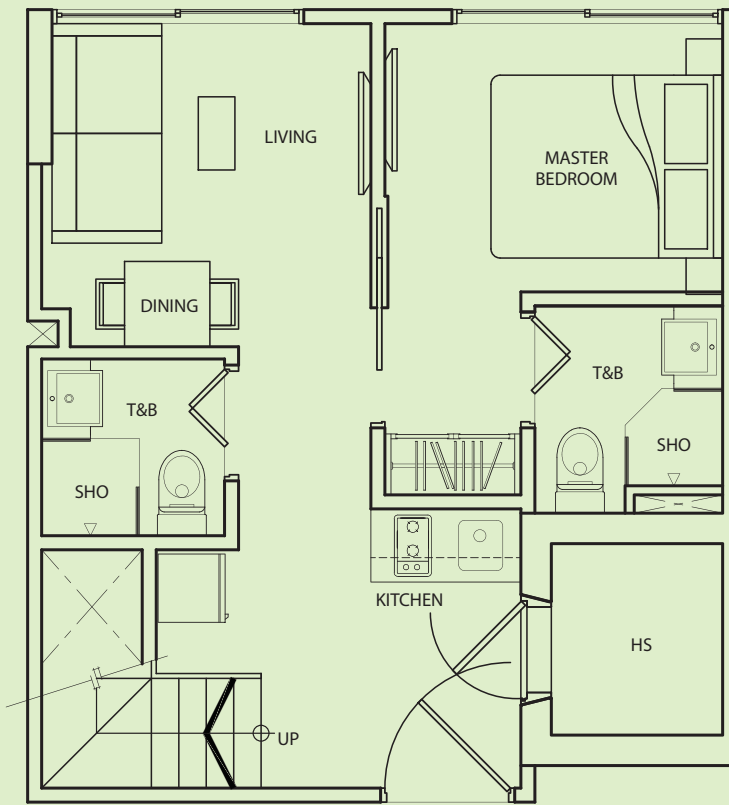

lower floor

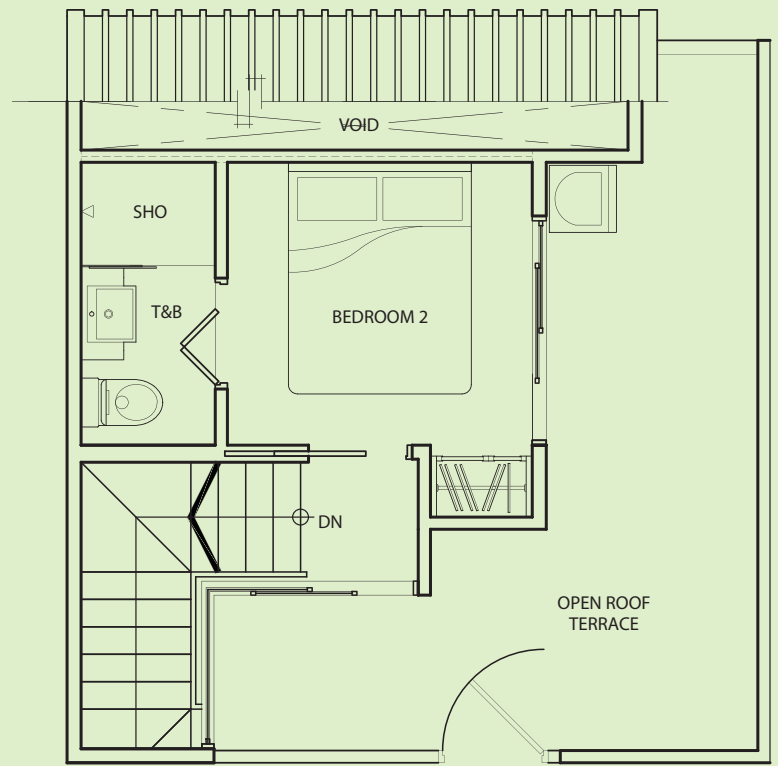

upper floor

TYPE B-P5D1

2 Bedroom  
+ 3 Bathroom  
66 sq m / 710 sq ft

#05-06

Inclusive of Roof Terrace,  
AC Ledge

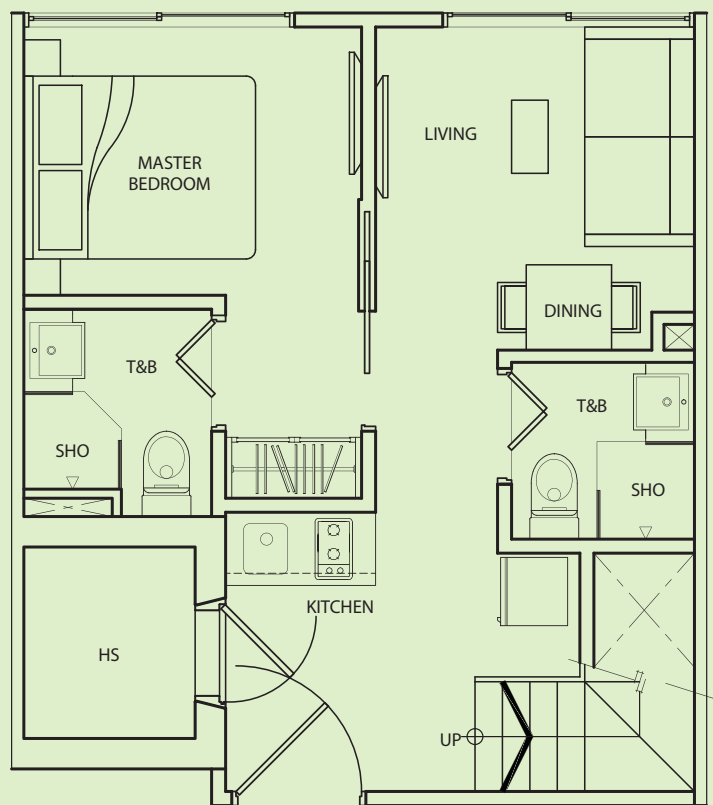

lower floor

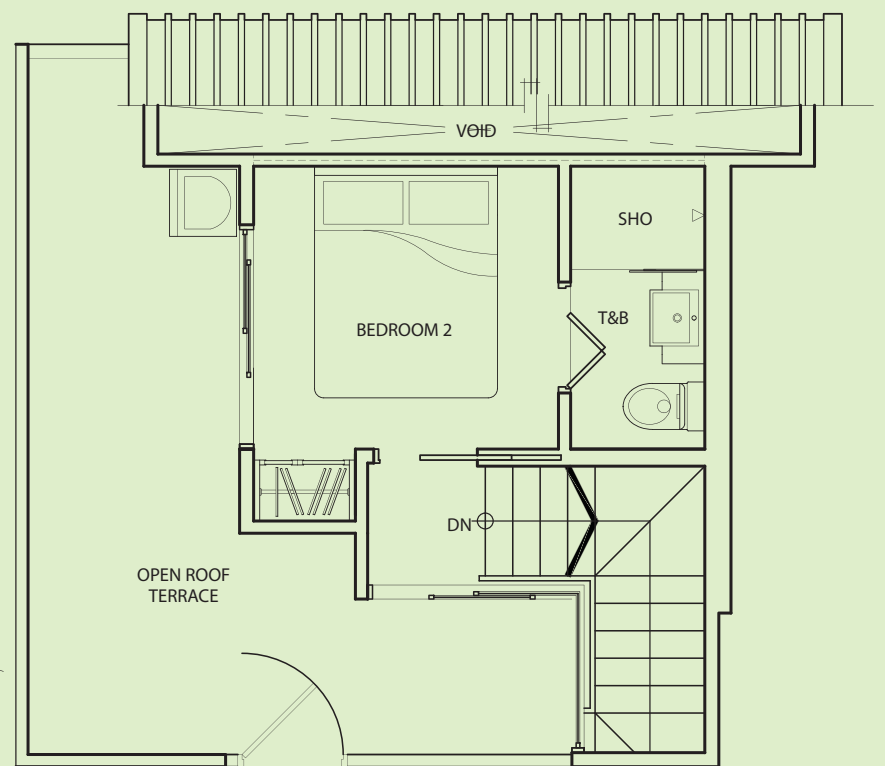

upper floor

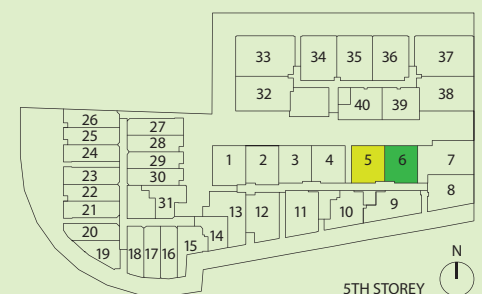

TYPE **B-P5E**

3 Bedroom  
 + 3 Bathroom  
 + Study Room  
 95 sq m / 1022 sq ft

#05-07

Inclusive of Roof Terrace, AC Ledge

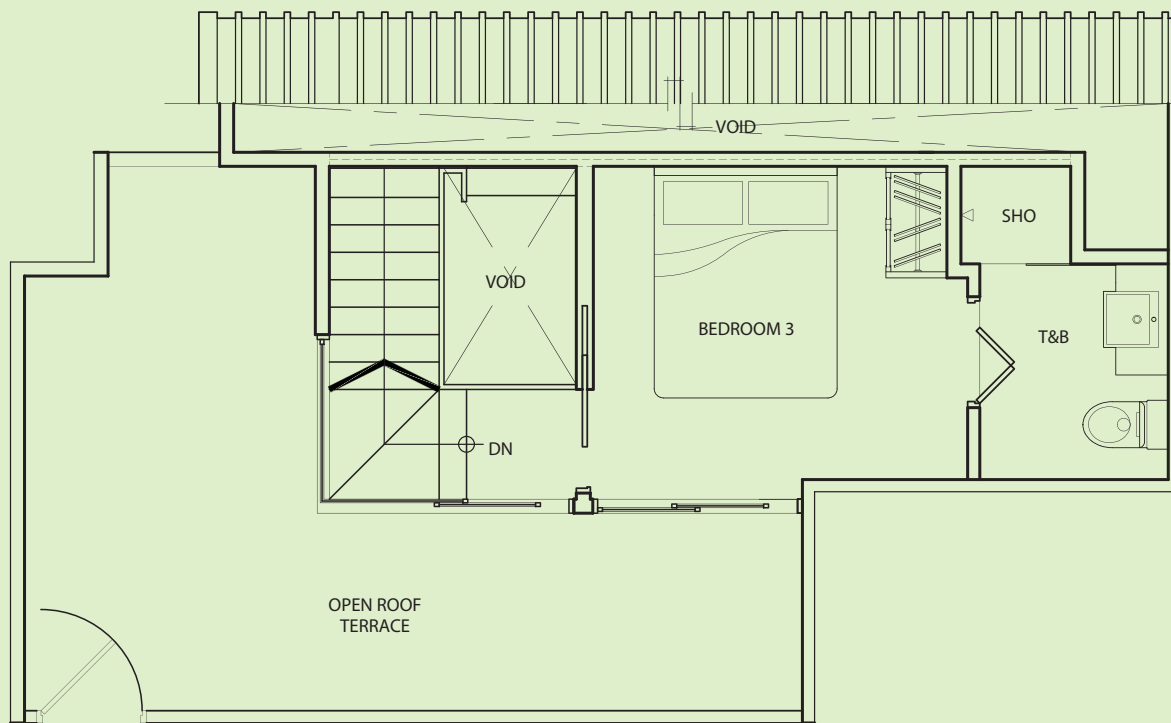

lower floor

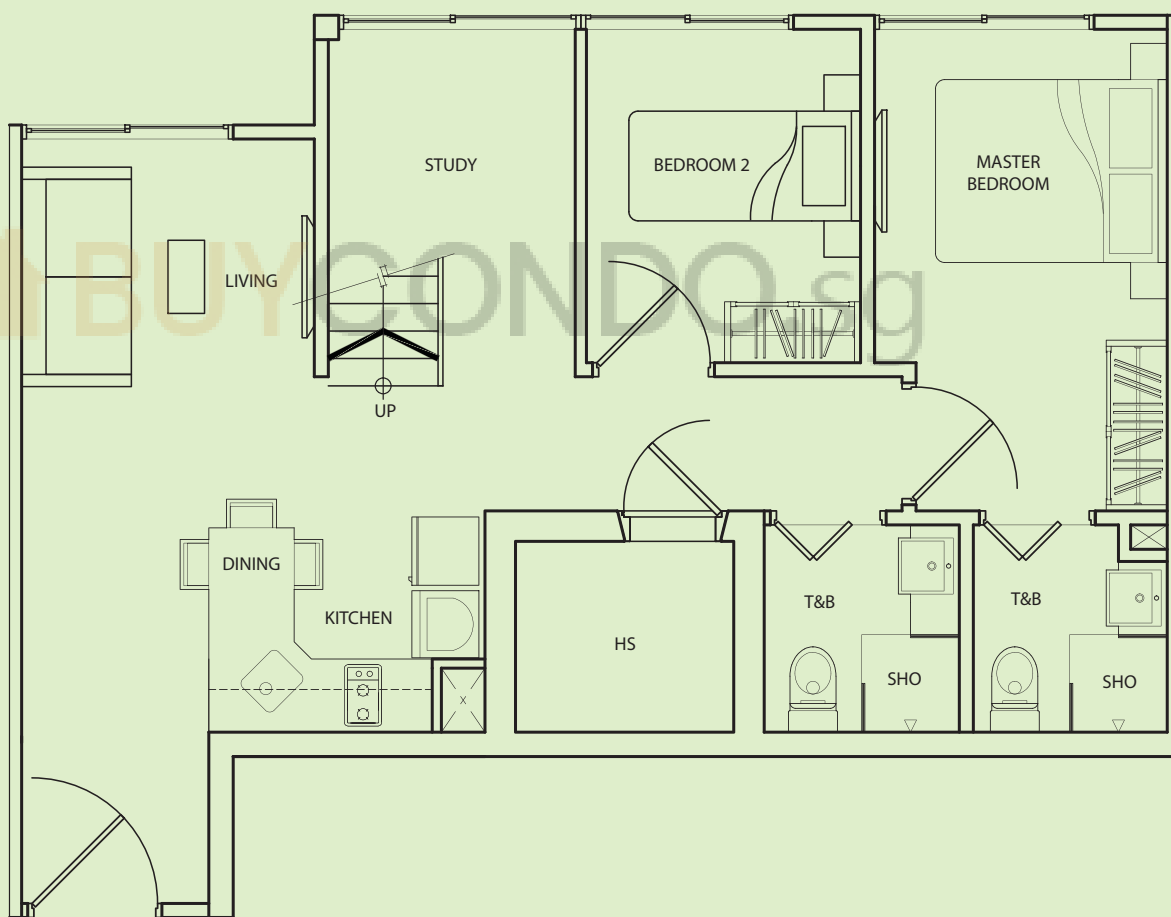

upper floor

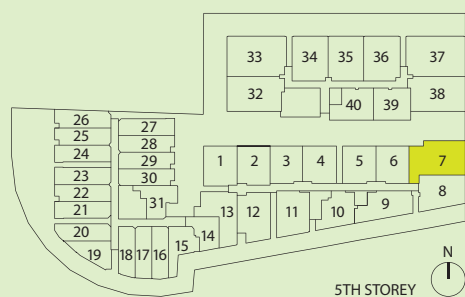

TYPE C-2A

2 Bedroom  
 + 2 Bathroom  
 + 1 Study Room  
 57 sq m / 818 sq ft

#02-32

Inclusive of PES, AC Ledge

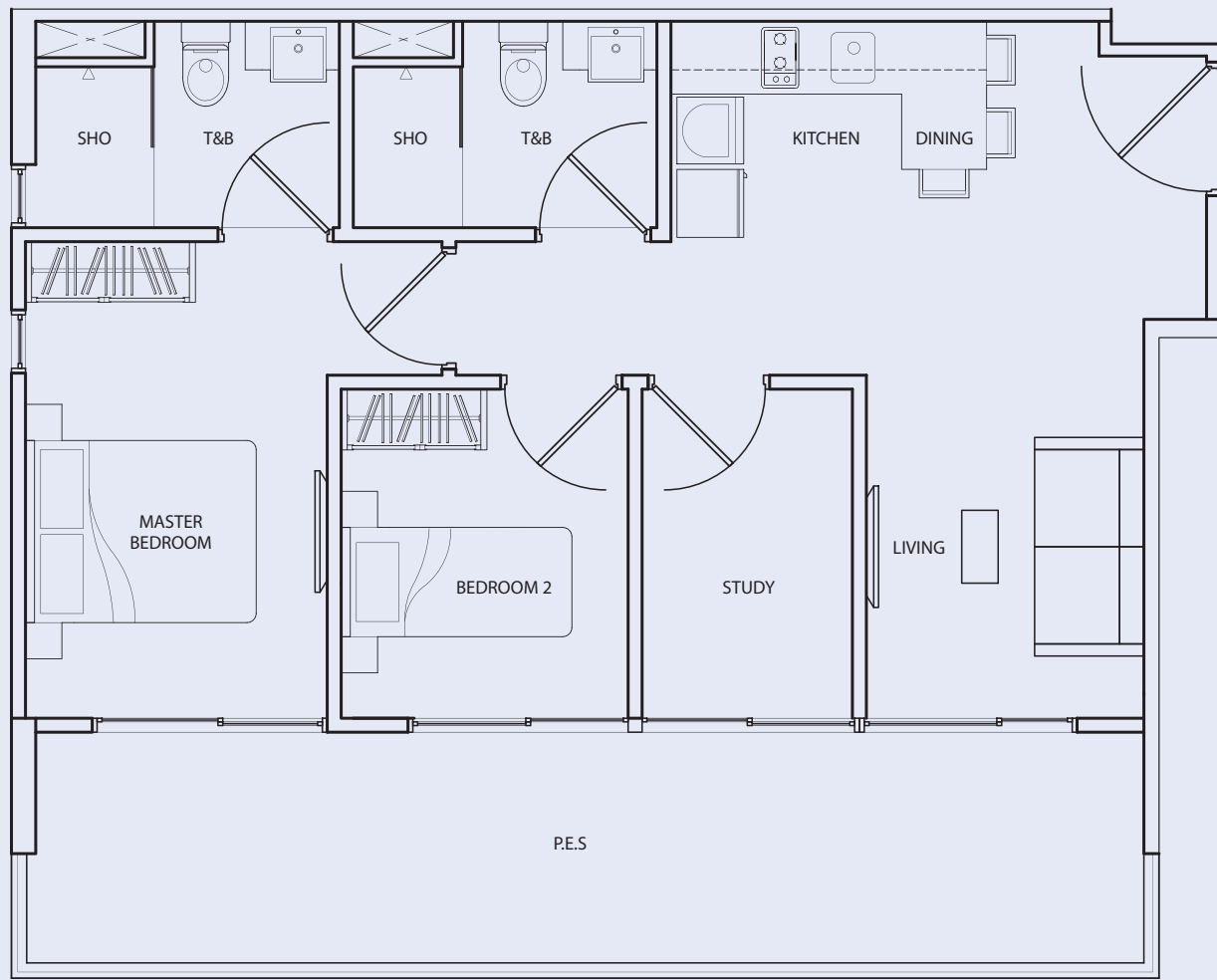

TYPE C-2B

3 Bedroom  
 + 2 Bathroom  
 71 sq m / 764 sq ft

#02-33

Inclusive of Balcony, AC Ledge

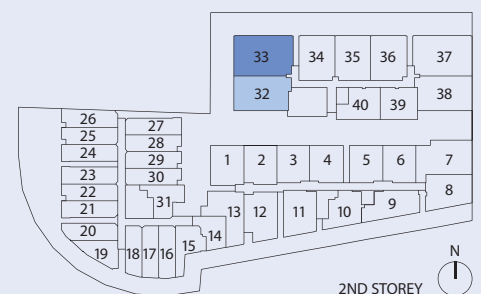
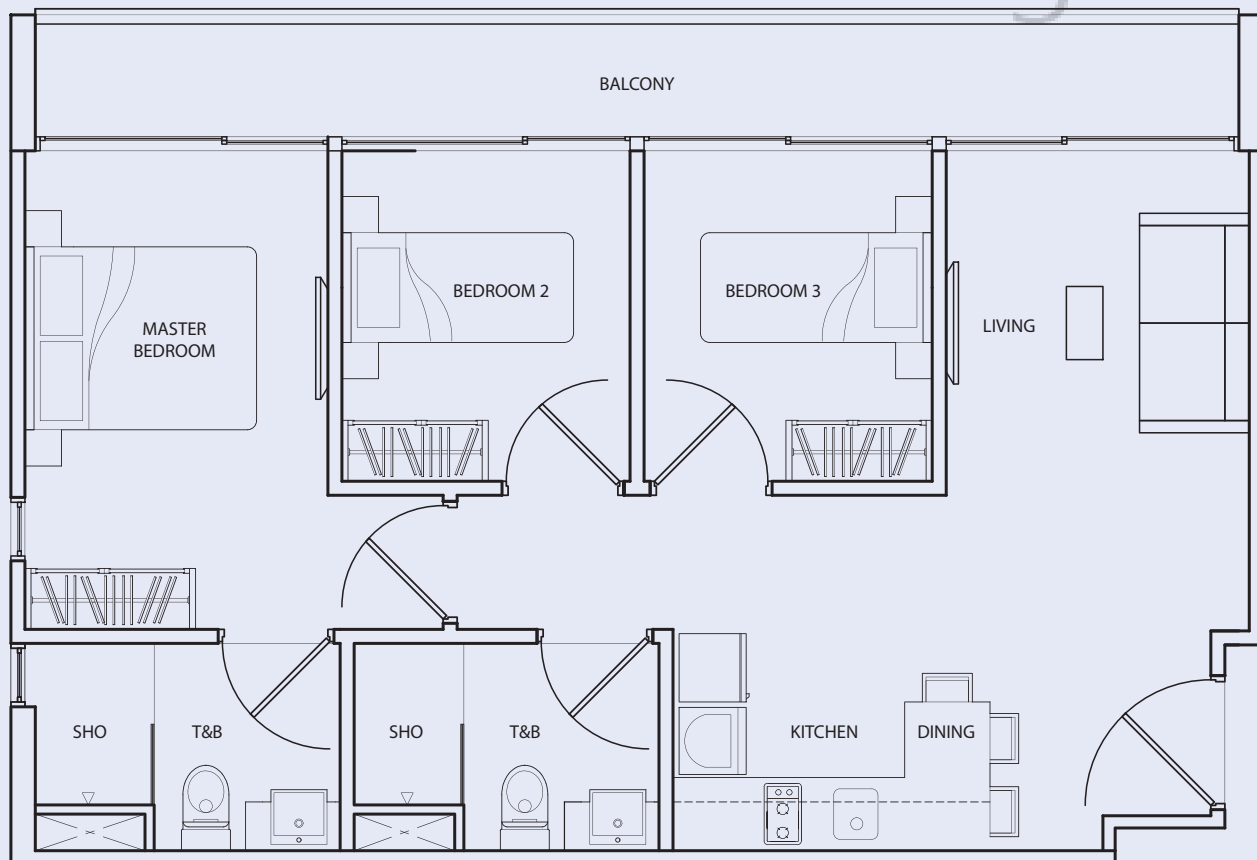

TYPE C-2C

1 Bedroom  
+ 2 Bathroom  
49 sq m / 527 sq ft

#02-34

Inclusive of Balcony, AC Ledge

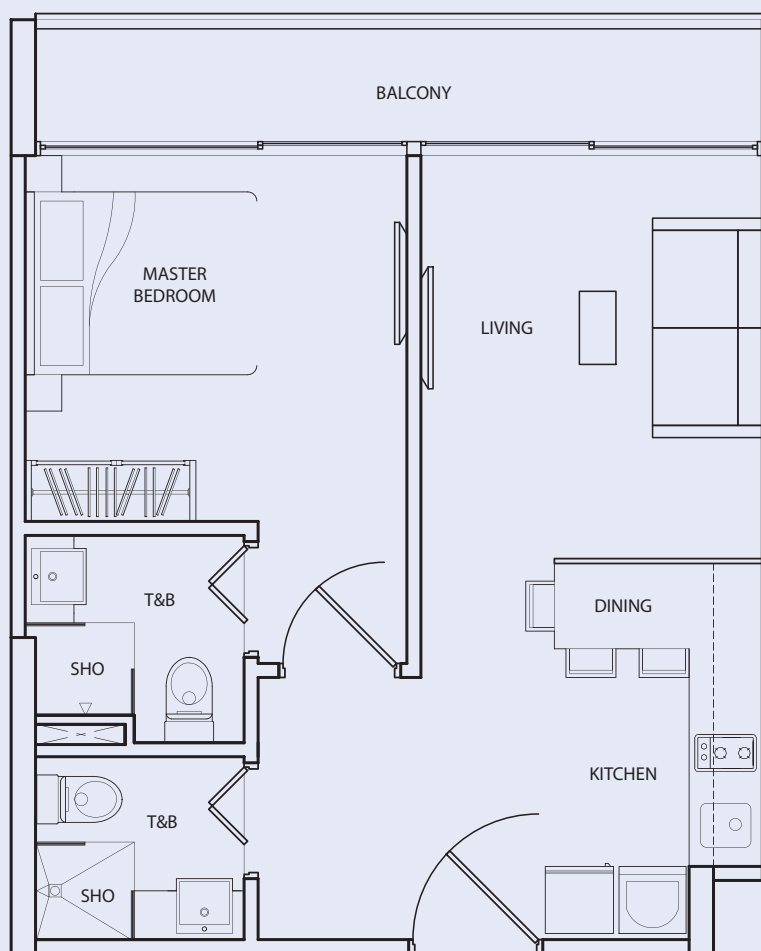

TYPE C-2D

1 Bedroom  
+ 2 Bathroom  
49 sq m / 527 sq ft

#02-35

Inclusive of Balcony, AC Ledge

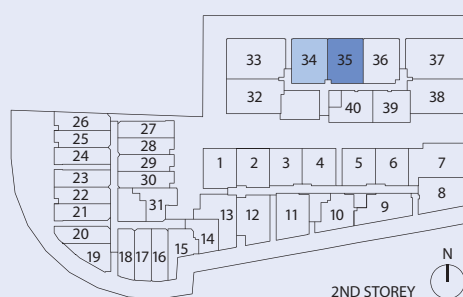
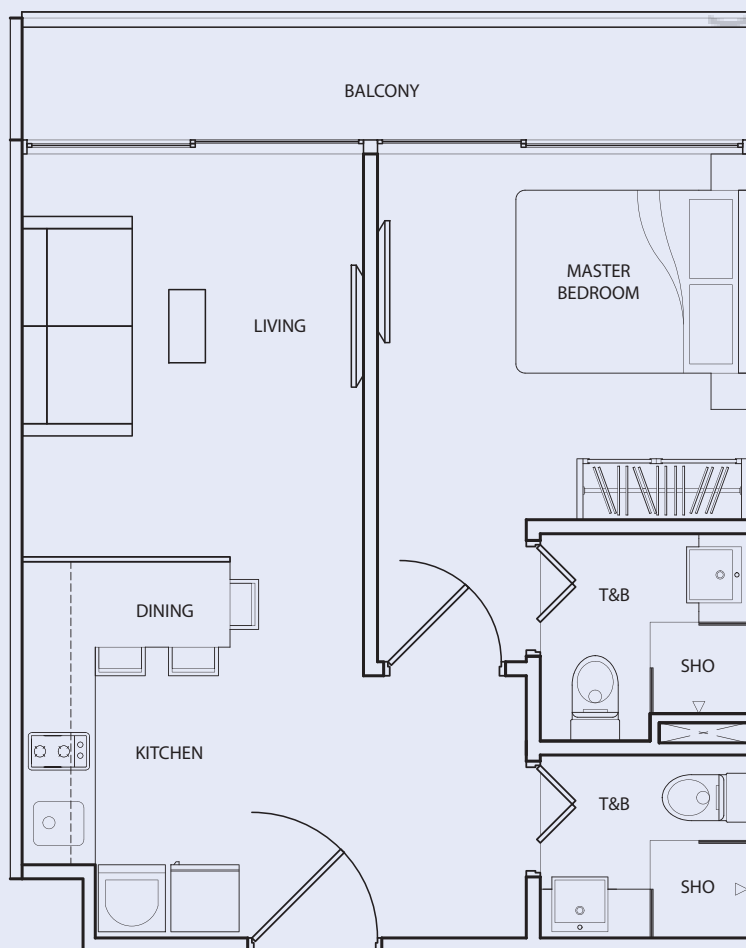

# BLOCK C

## TYPE C-2E

1 Bedroom  
+ 2 Bathroom  
48 sq m / 517 sq ft

#02-36

Inclusive of Balcony, AC Ledge

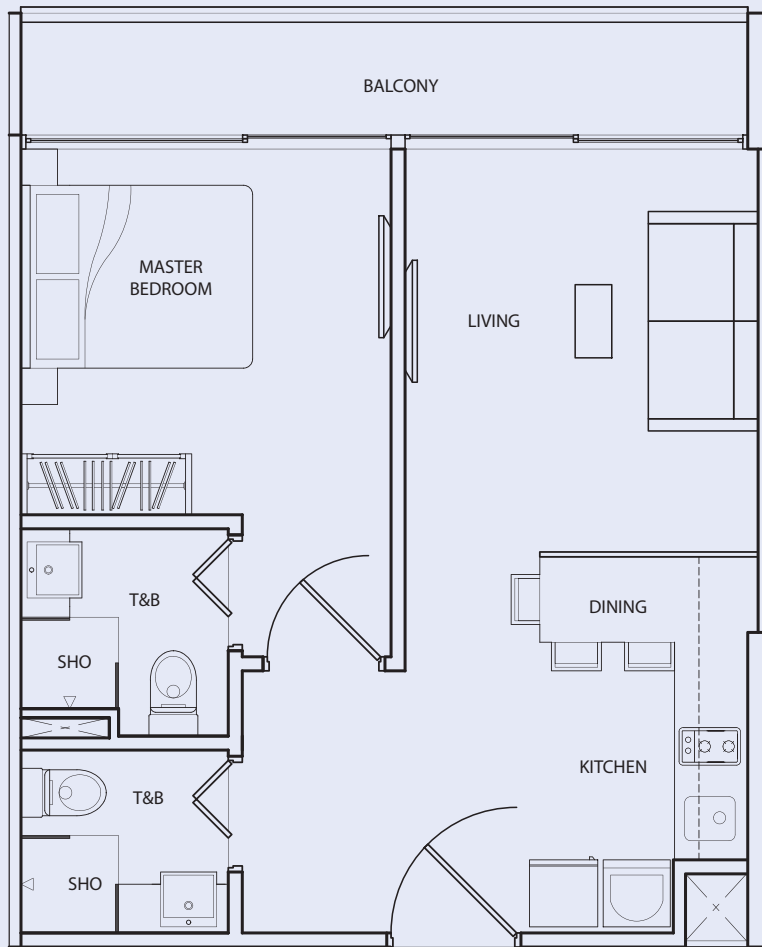

## TYPE C-2F

3 Bedroom  
+ 2 Bathroom  
71 sq m / 764 sq ft

#02-37

Inclusive of Balcony, AC Ledge

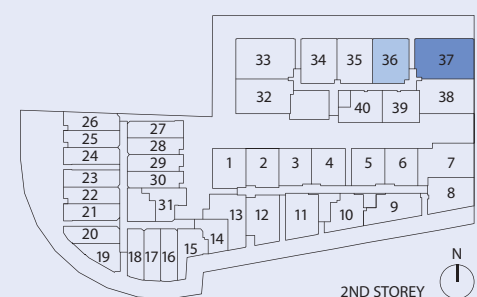
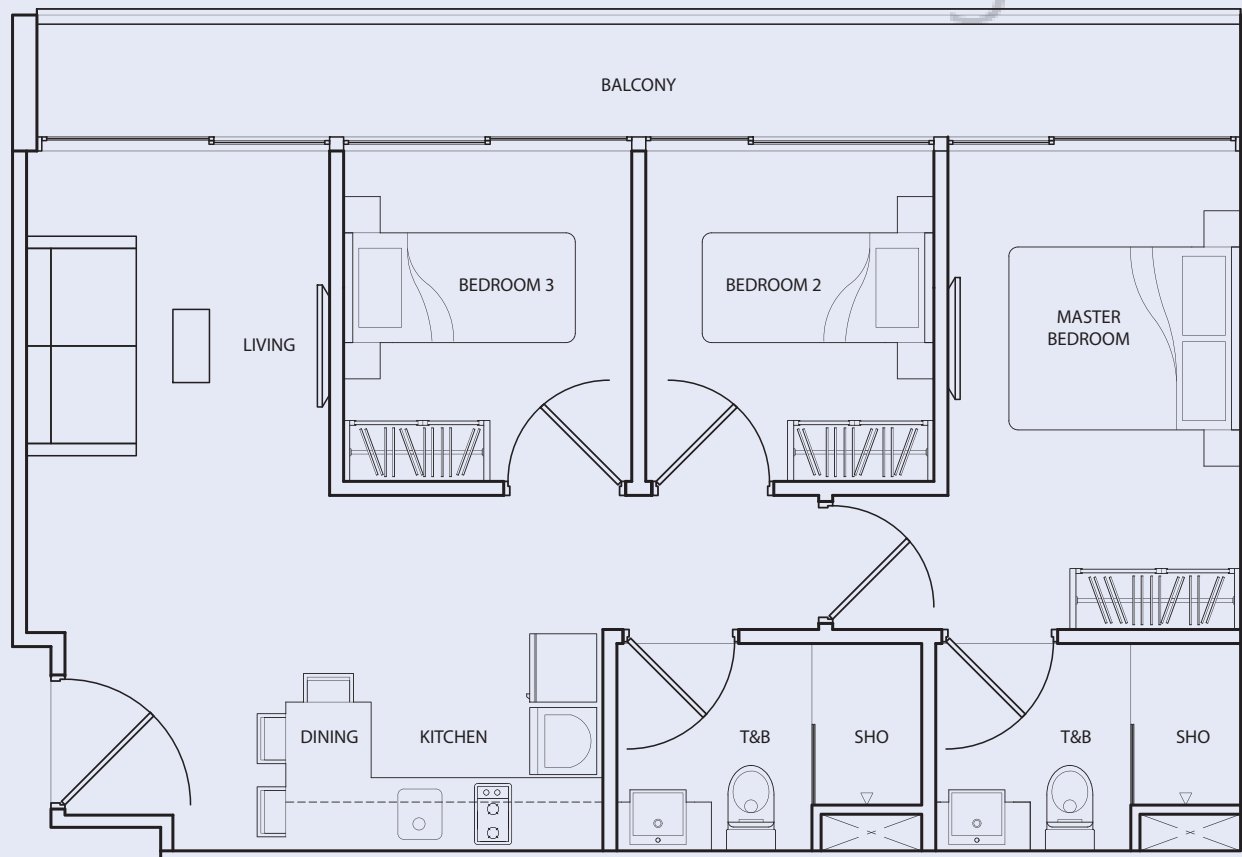

TYPE C-2G

2 Bedroom  
+ 2 Bathroom  
+ 1 Study Room  
75 sq m / 807 sq ft

#02-38

Inclusive of PES, AC Ledge

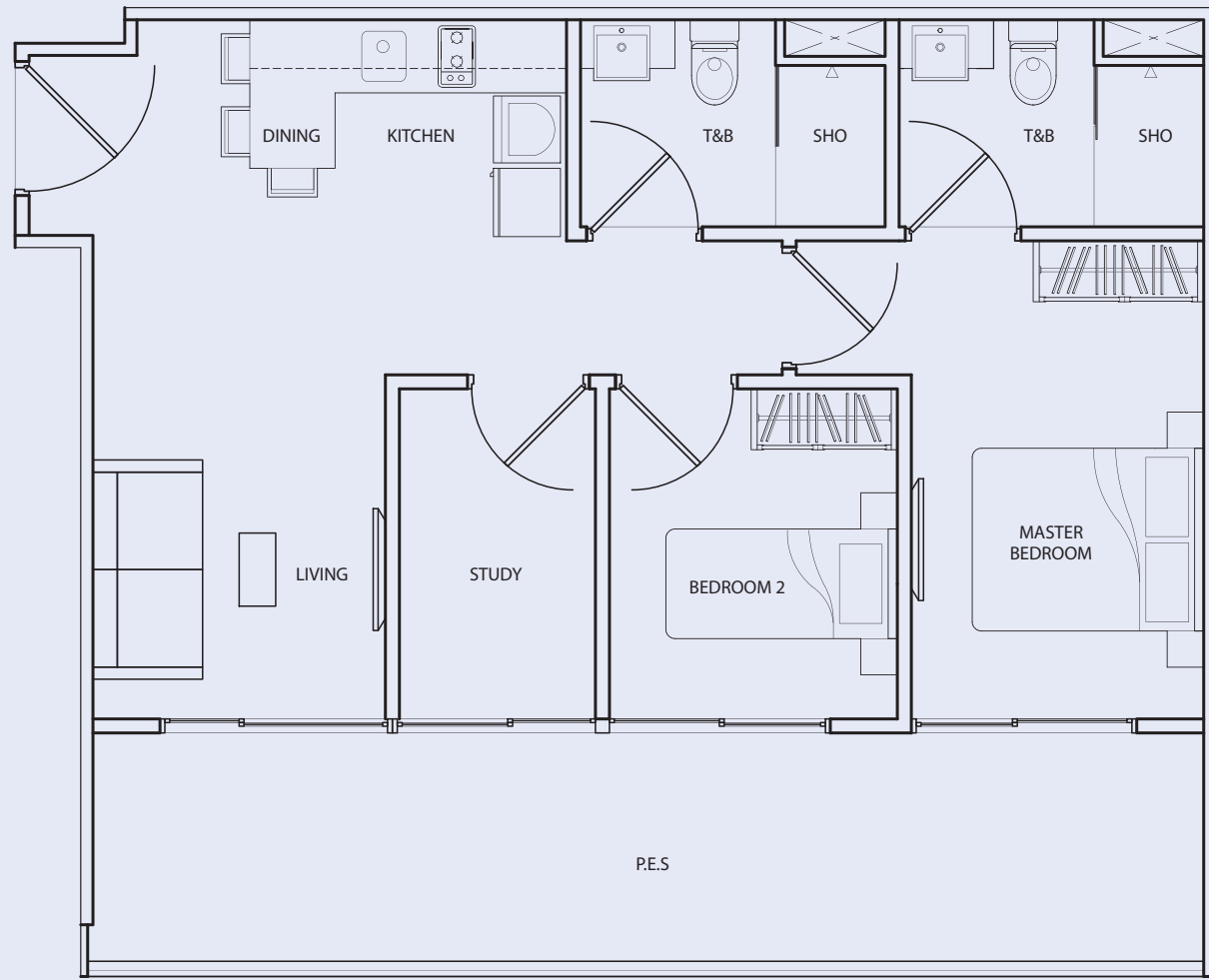

TYPE C-2H

1 Bedroom  
+ 2 Bathroom  
45 sq m / 484 sq ft

#02-39

Inclusive of PES, AC Ledge

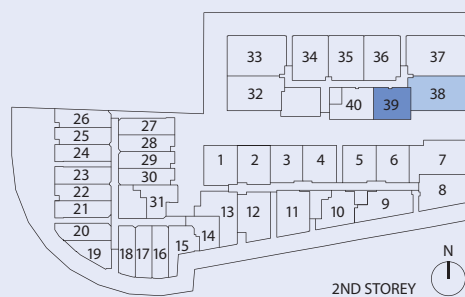
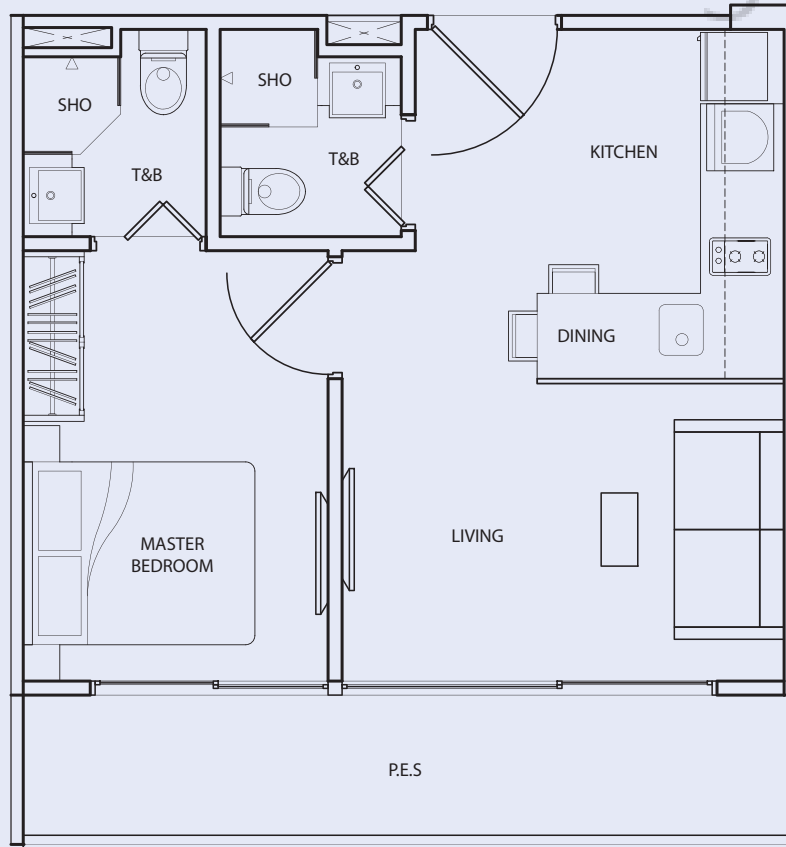



TYPE C-2I

2 Bedroom  
+ 2 Bathroom  
47 sq m / 506 sq ft

#02-40

Inclusive of PES, AC Ledge

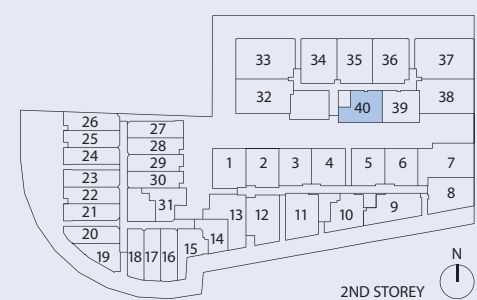
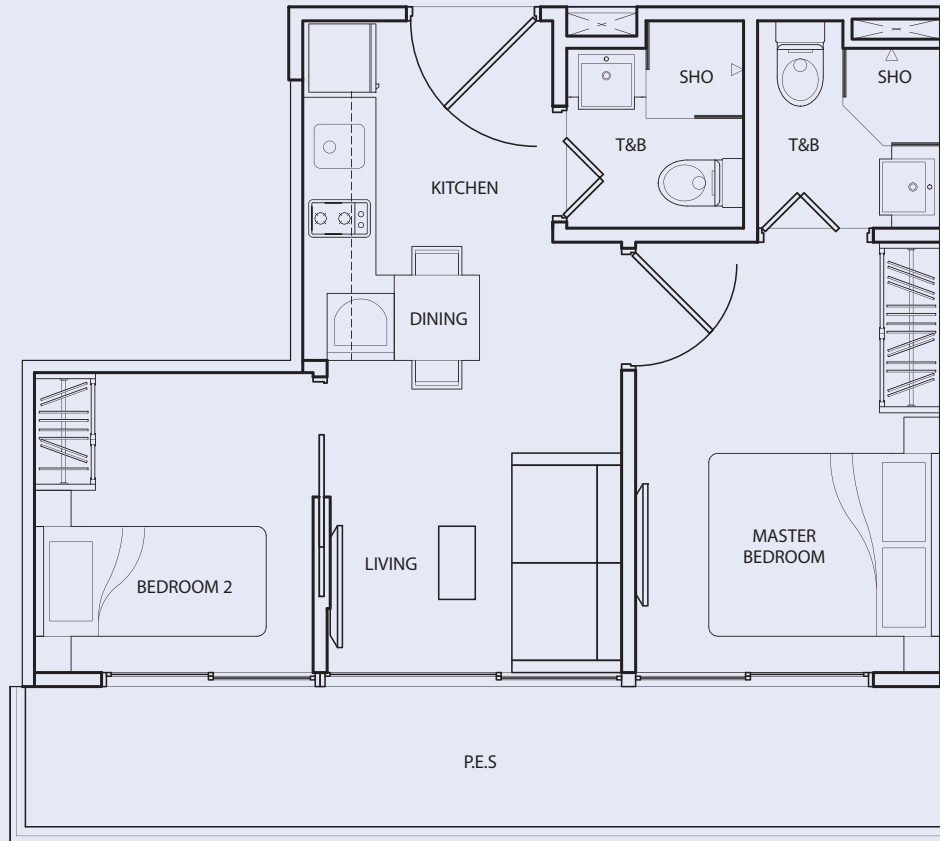

TYPE C-3A

2 Bedroom  
 + 2 Bathroom  
 + 1 Study Room  
 57 sq m / 613 sq ft

#03-32  
 #04-32

Inclusive of AC Ledge

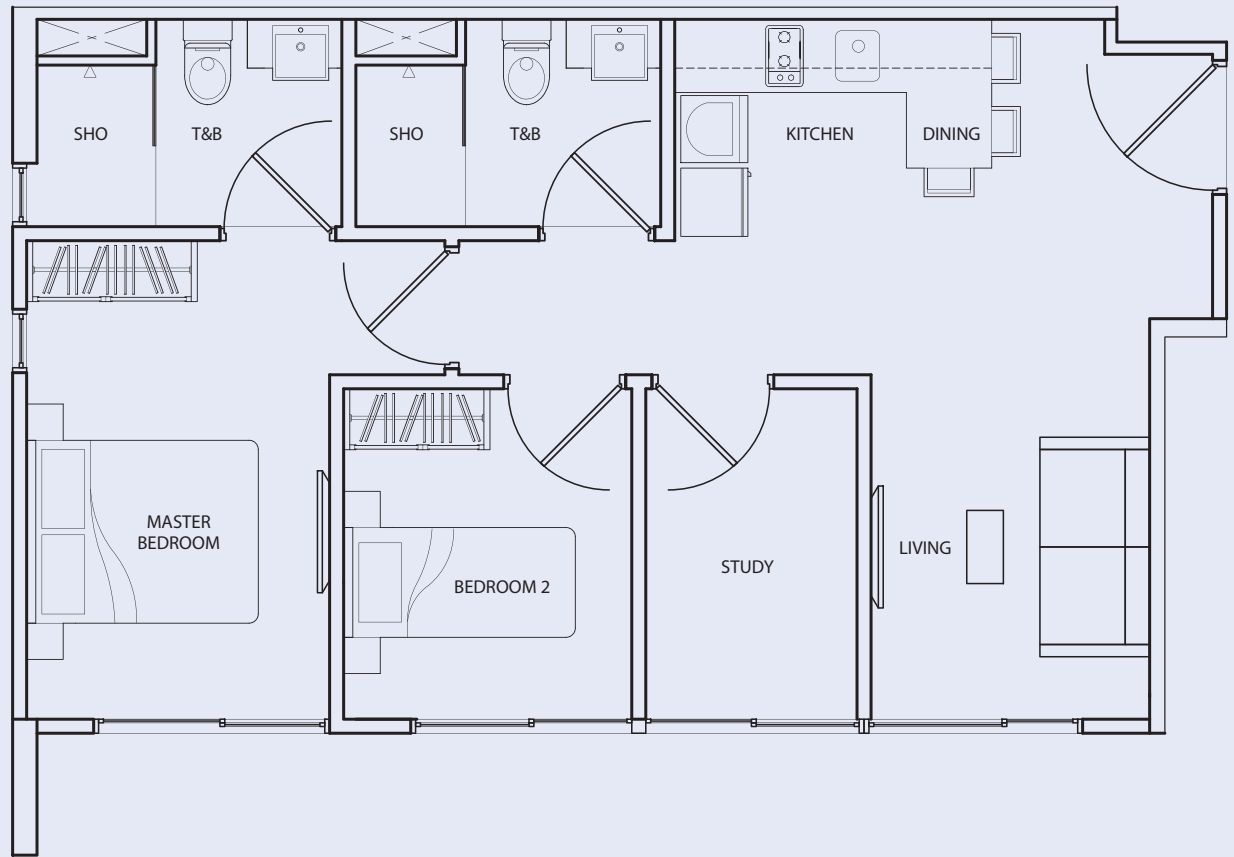

TYPE C-3B

3 Bedroom  
 + 2 Bathroom  
 71 sq m / 764 sq ft

#03-33  
 #04-33

Inclusive of Balcony, AC Ledge

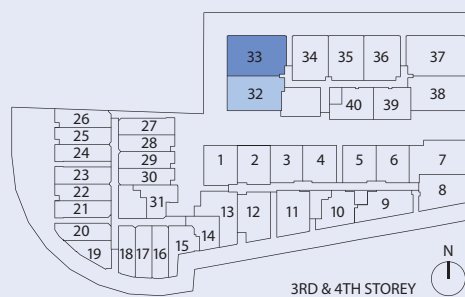
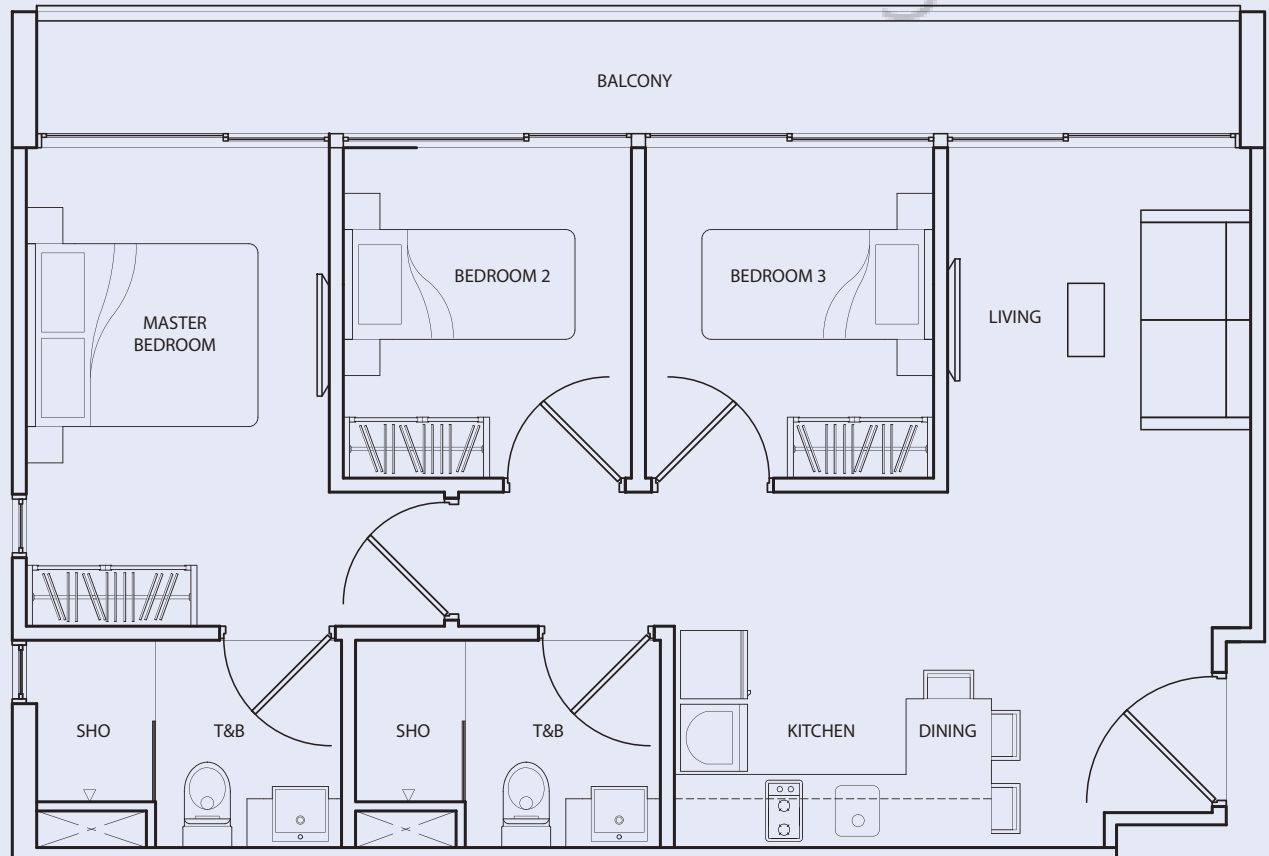

# BLOCK C

## TYPE C-3C

1 Bedroom  
+ 2 Bathroom  
49 sq m / 527 sq ft

#03-34

Inclusive of Balcony, AC Ledge

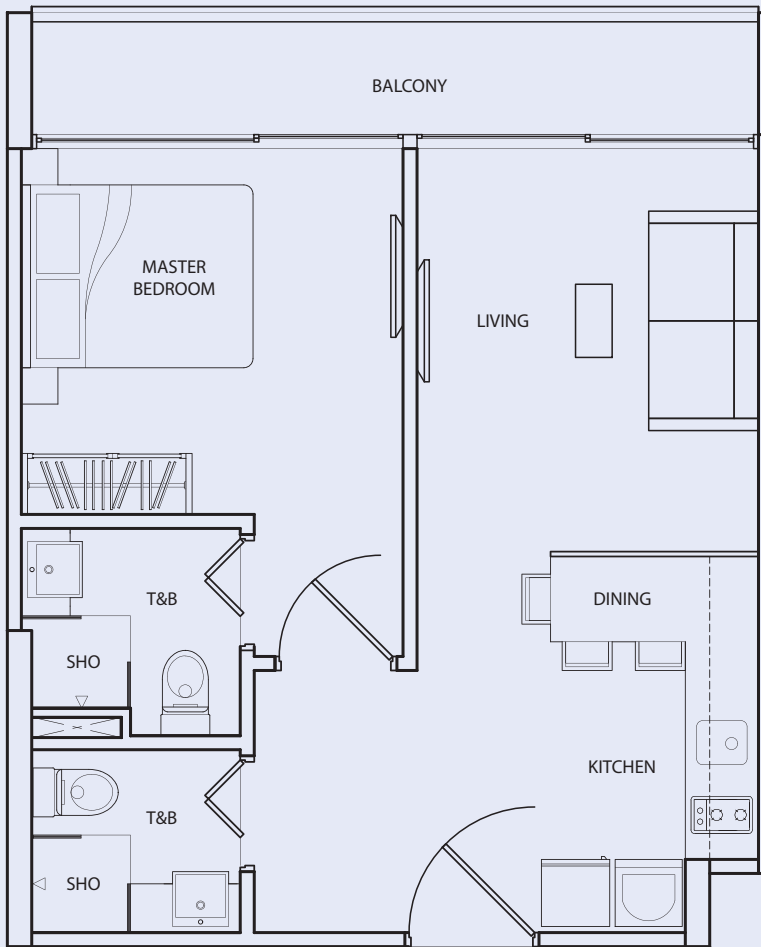

## TYPE C-3D

1 Bedroom  
+ 2 Bathroom  
49 sq m / 527 sq ft

#03-35

Inclusive of Balcony, AC Ledge

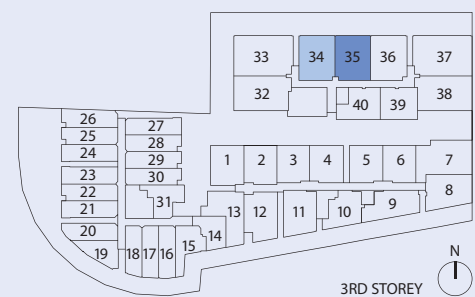
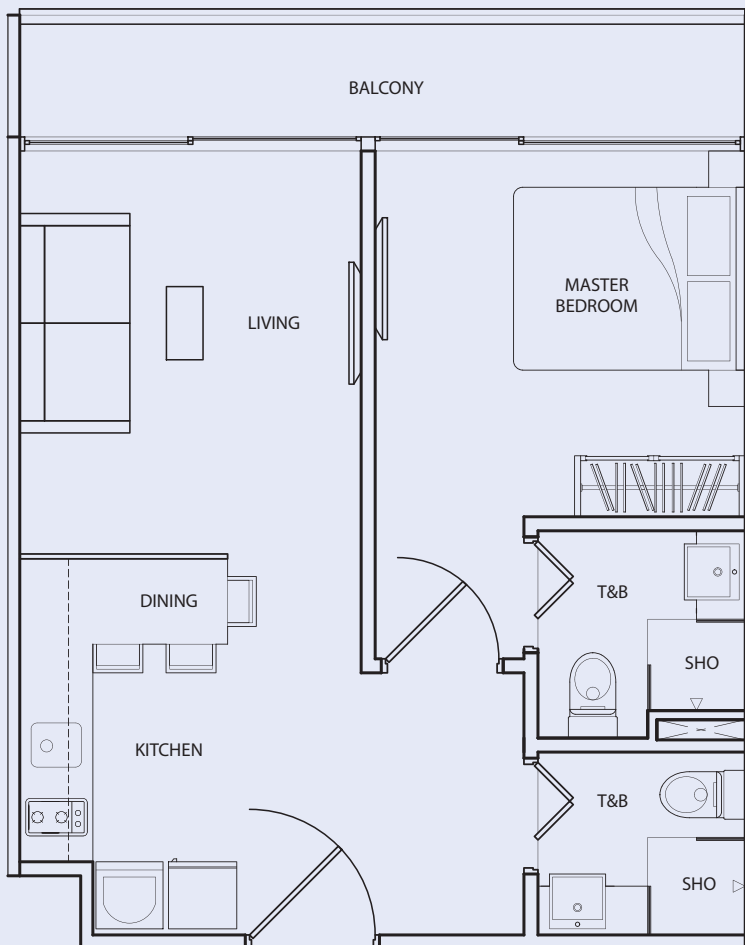

TYPE C-3E

1 Bedroom  
+ 2 Bathroom  
48 sq m / 517 sq ft

#03-36

Inclusive of Balcony, AC Ledge

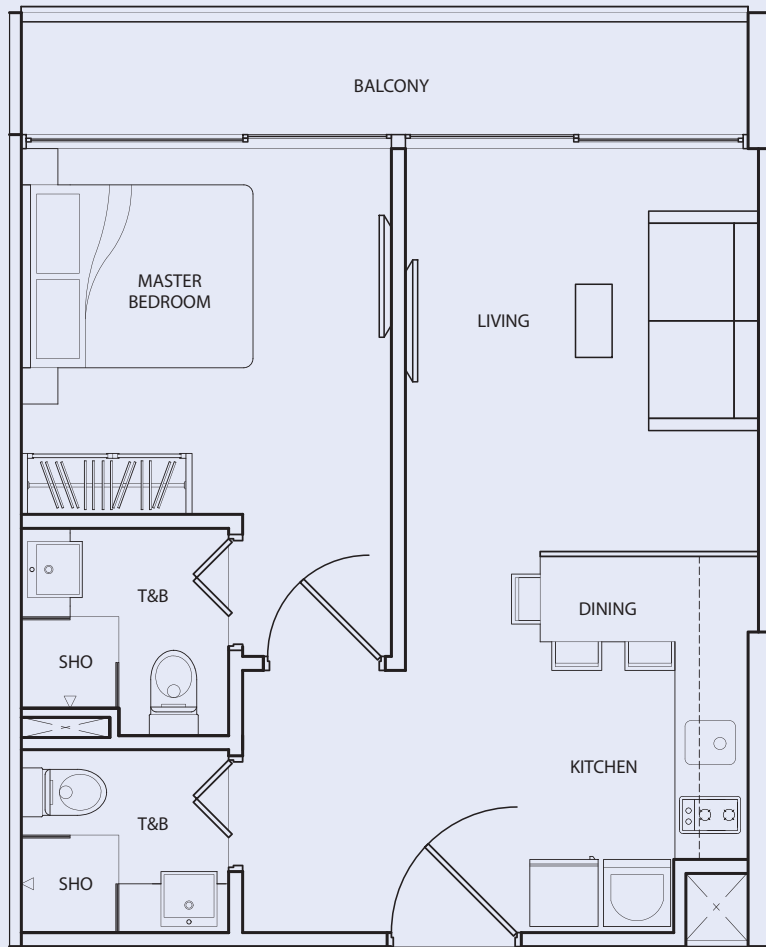

TYPE C-3F

3 Bedroom  
+ 2 Bathroom  
71 sq m / 764 sq ft

#03-37

#04-37

Inclusive of Balcony, AC Ledge

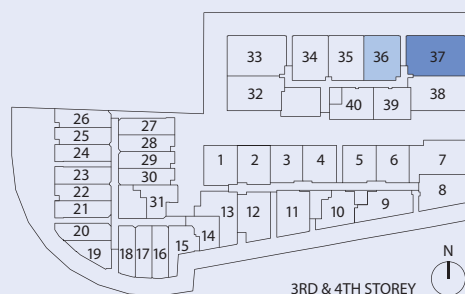
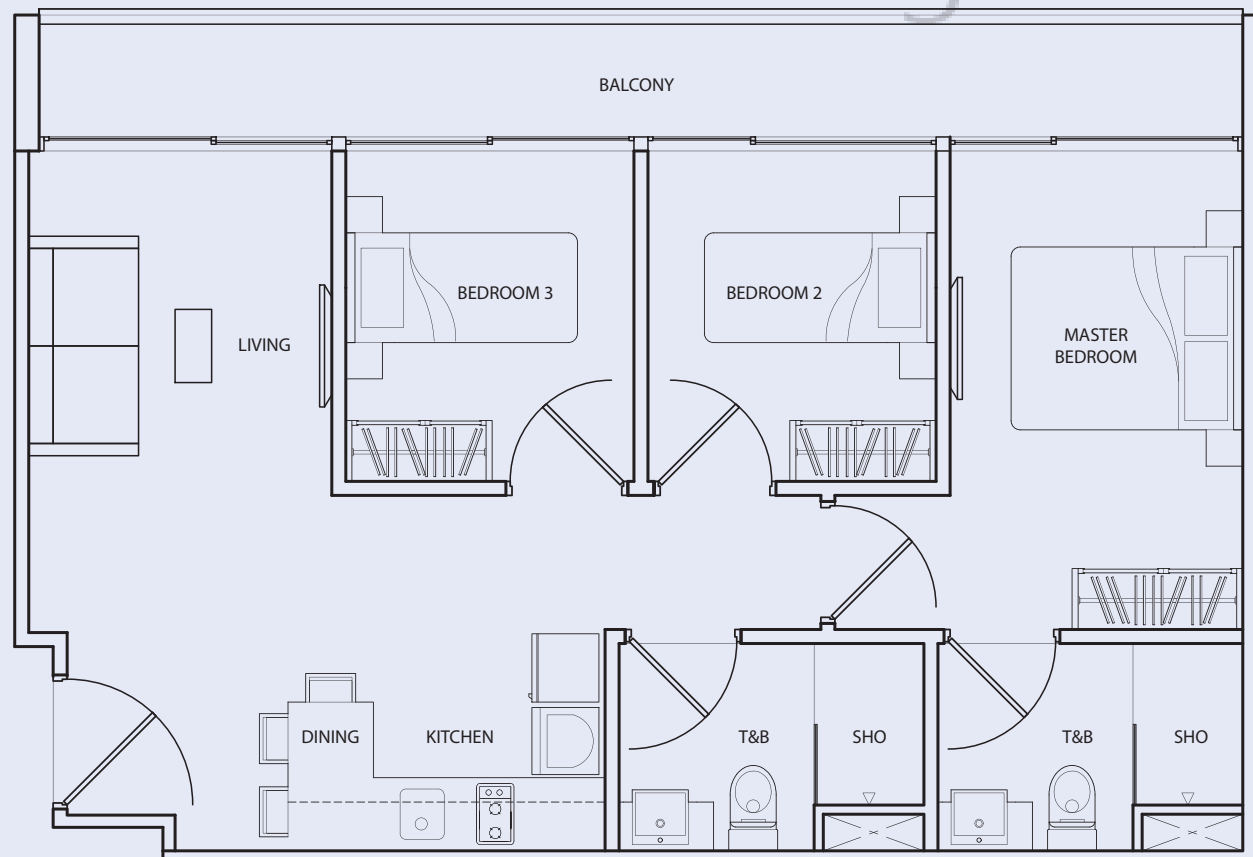

# BLOCK C

## TYPE C-3G

2 Bedroom  
+ 2 Bathroom  
+ 1 Study Room  
57 sq m / 613 sq ft

#03-38

#04-38

Inclusive of AC Ledge

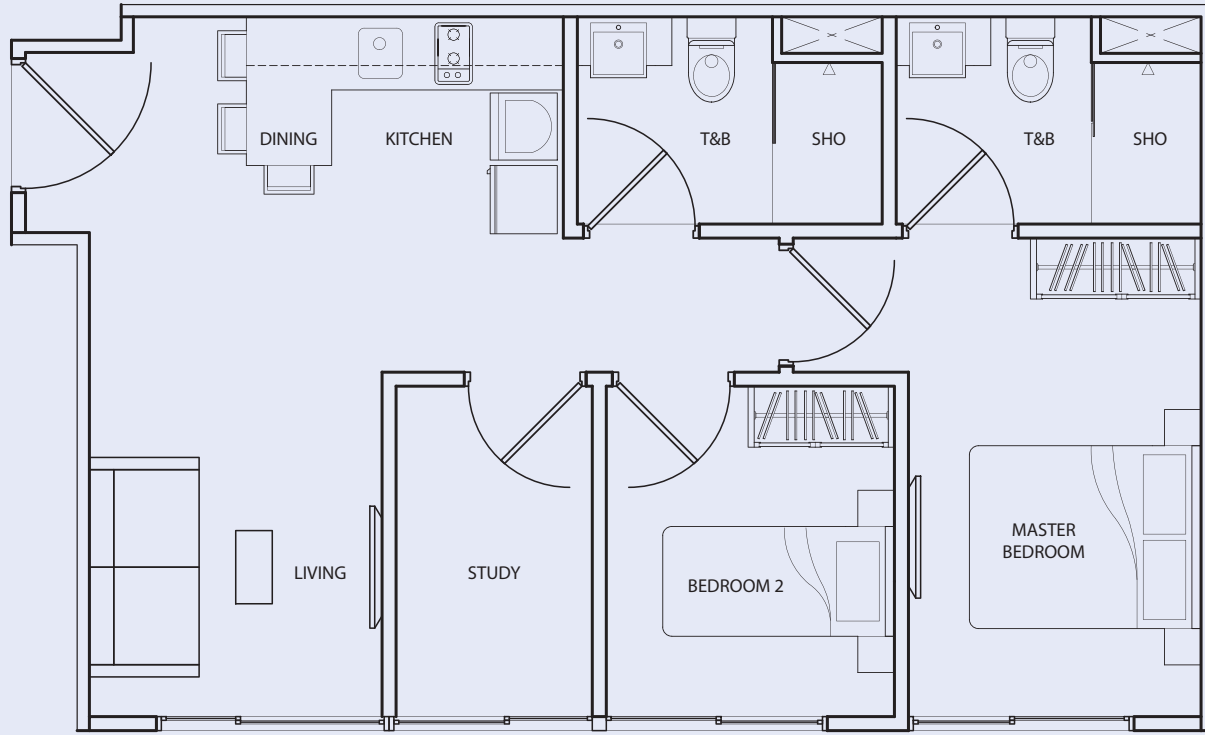

## TYPE C-3H

1 Bedroom  
+ 2 Bathroom  
37 sq m / 398 sq ft

#03-39

#04-39

Inclusive of AC Ledge

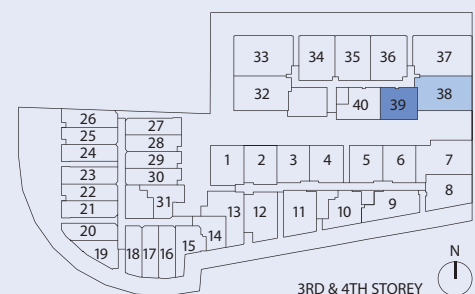
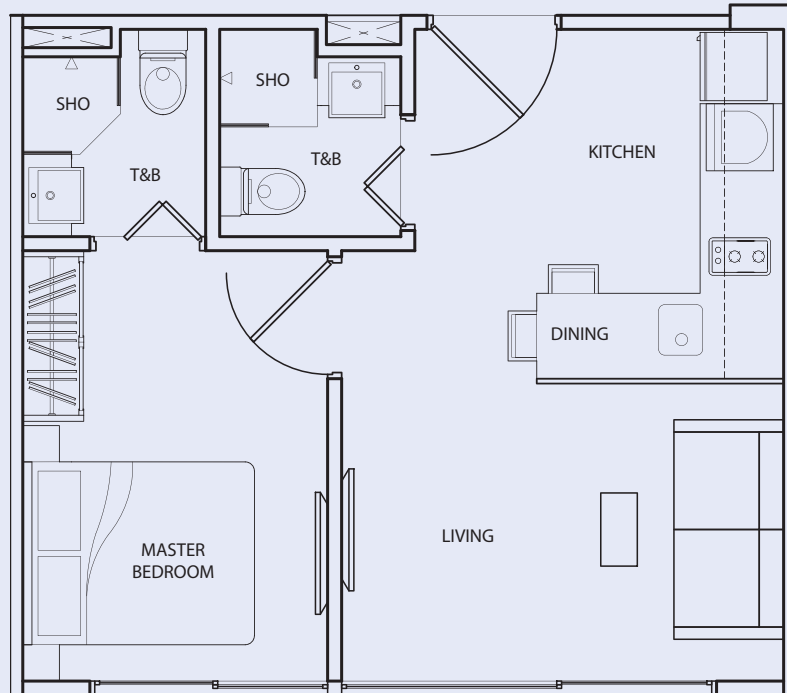

3RD & 4TH STOREY

TYPE C-3I

2 Bedroom  
+ 2 Bathroom  
37 sq m / 398 sq ft

#03-40  
#04-40

Inclusive of AC Ledge

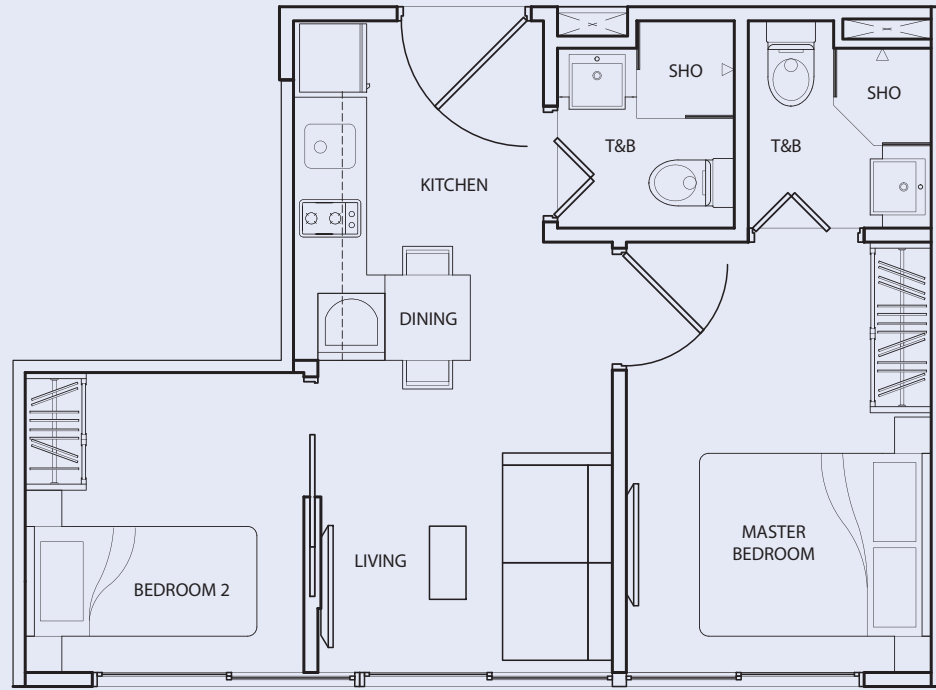

TYPE C-4C

1 Bedroom  
+ 2 Bathroom  
48 sq m / 517 sq ft

#04-34

Inclusive of Balcony, AC Ledge

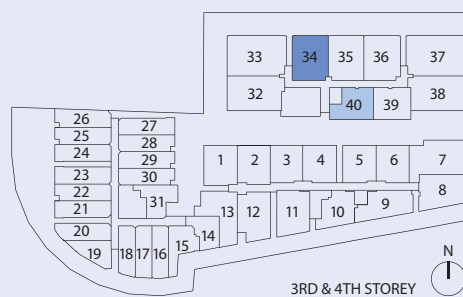
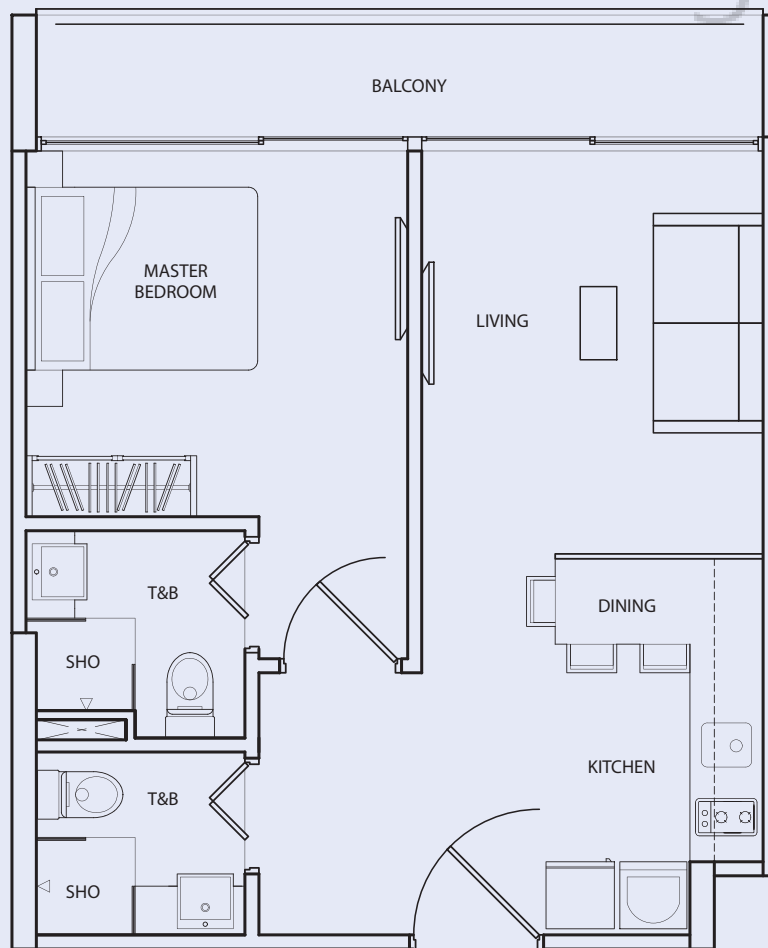

TYPE C-4D

1 Bedroom  
+ 2 Bathroom  
47 sq m / 506 sq ft

#04-35

Inclusive of Balcony, AC Ledge

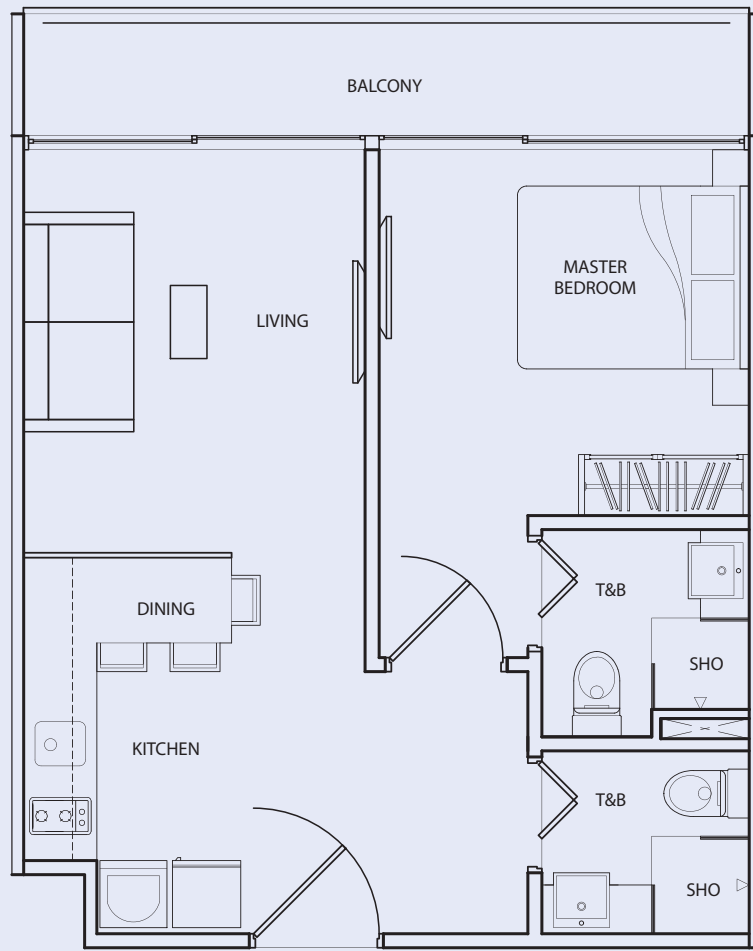

TYPE C-4E

1 Bedroom  
+ 2 Bathroom  
47 sq m / 506 sq ft

#04-36

Inclusive of Balcony, AC Ledge

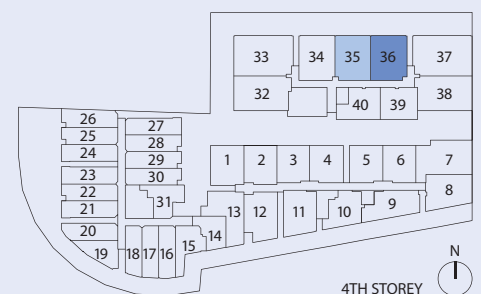
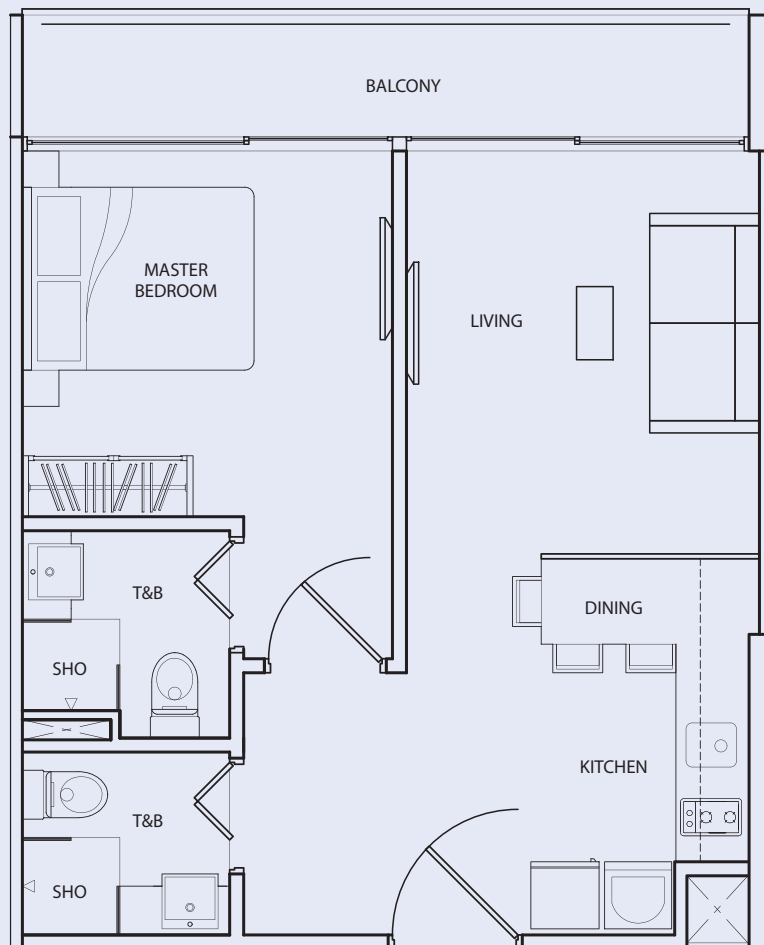

TYPE C-P5A

3 Bedroom  
 + 3 Bathroom  
 + 1 Study Room  
 104 sq m / 1119 sq ft

#05-32

Inclusive of Roof Terrace, AC Ledge

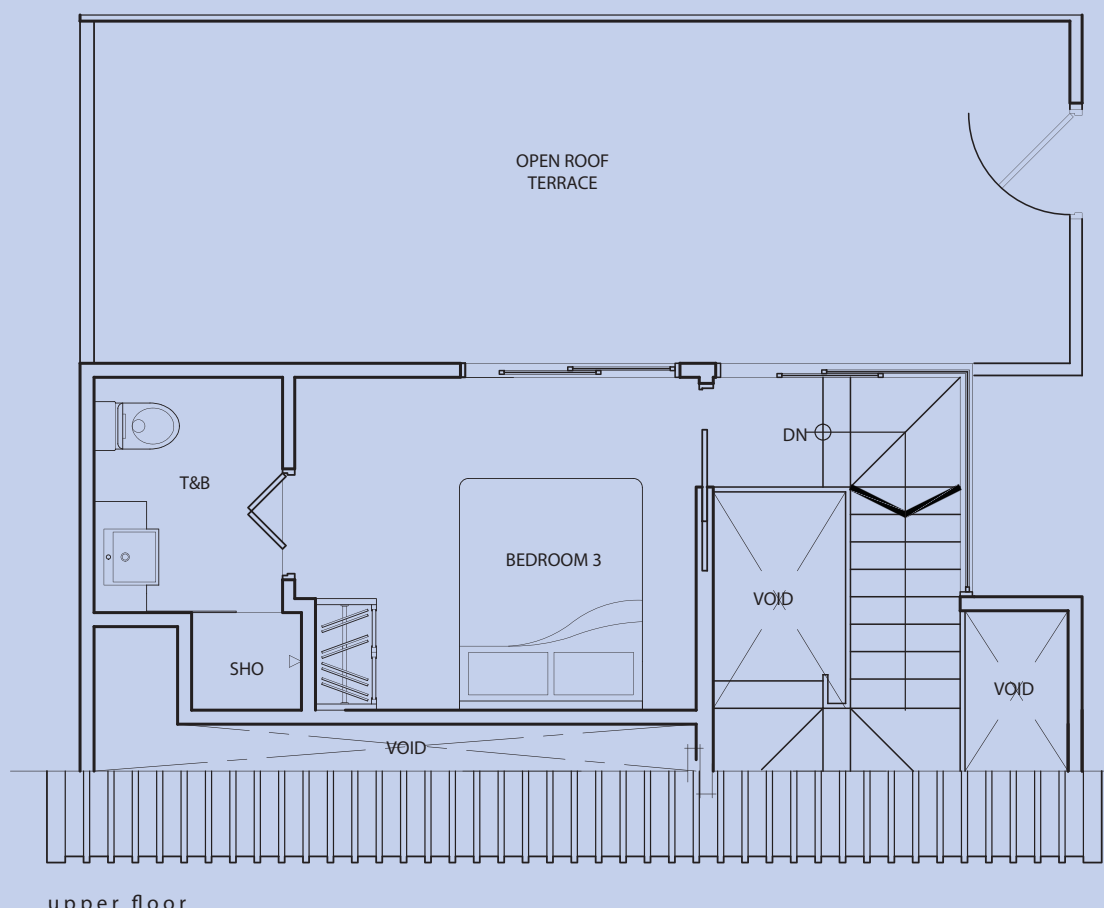

upper floor

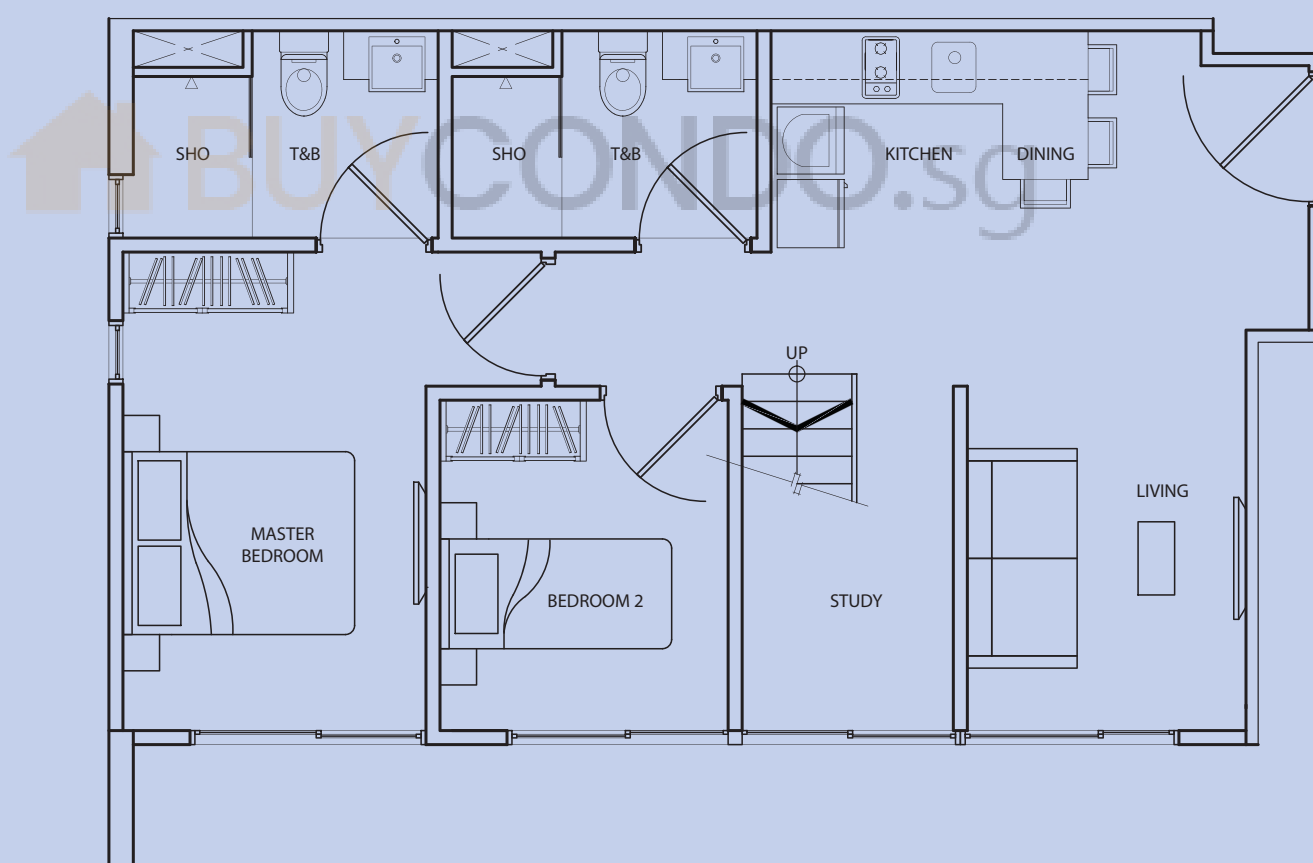

lower floor

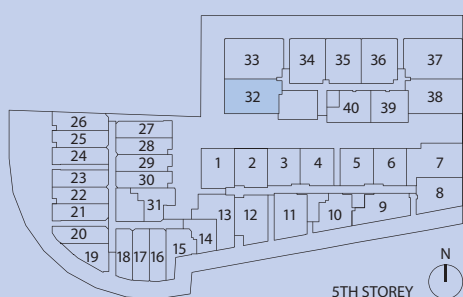



## TYPE C-P5B

3 Bedroom  
 + 3 Bathroom  
 + 1 Study Room  
 118 sq m / 1270 sq ft

#05-33

Inclusive of Balcony, Roof Terrace,  
 AC Ledge

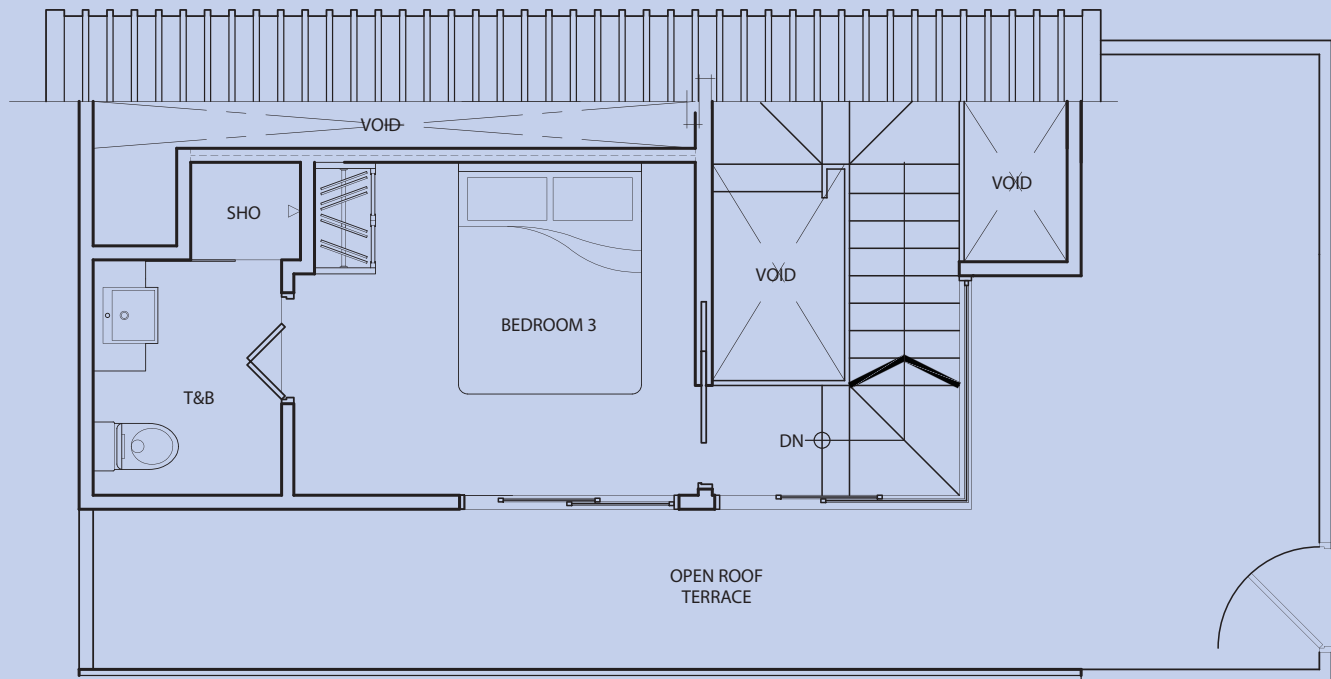

upper floor

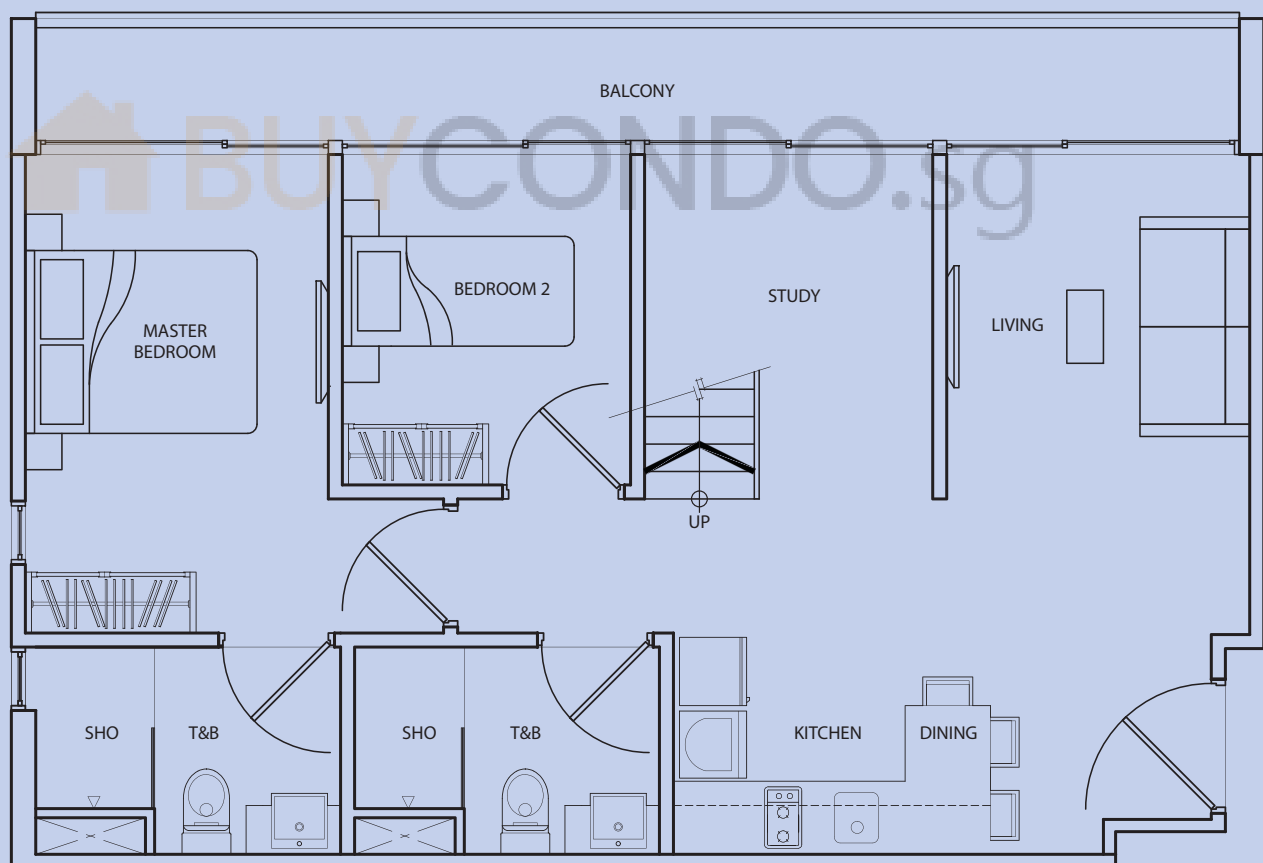

lower floor

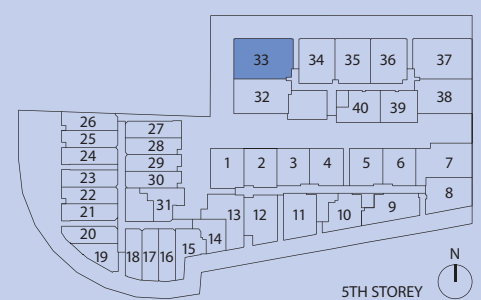

TYPE C-P5C

2 Bedroom  
+ 3 Bathroom  
80 sq m / 861 sq ft

#05-34

Inclusive of Balcony, Roof Terrace,  
AC Ledge

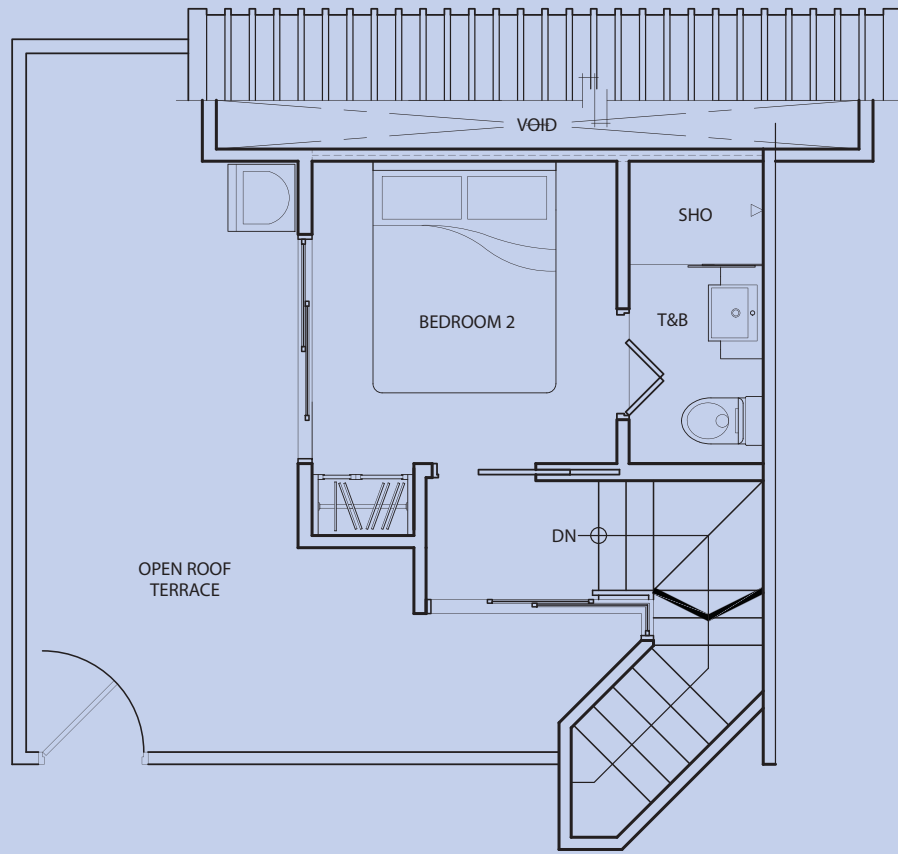

upper floor

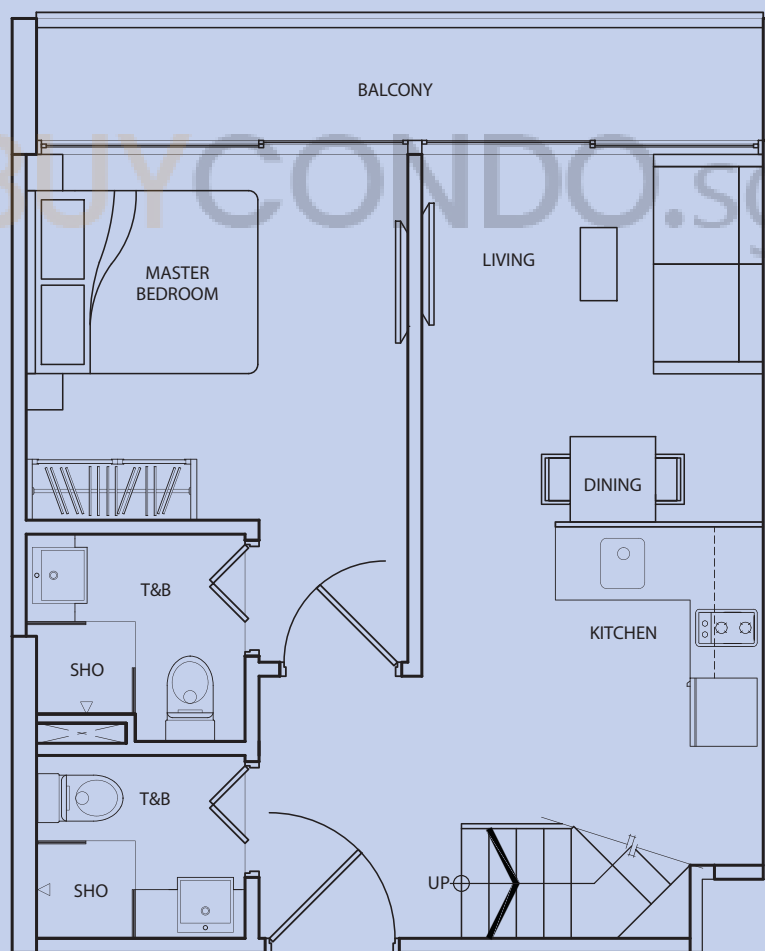

lower floor

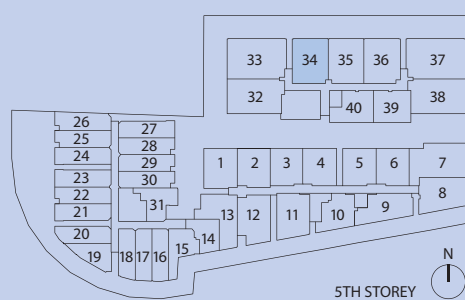

5TH STOREY

TYPE C-P5D

2 Bedroom  
+ 3 Bathroom  
78 sq m / 840 sq ft

#05-35

Inclusive of Balcony, Roof Terrace,  
AC Ledge

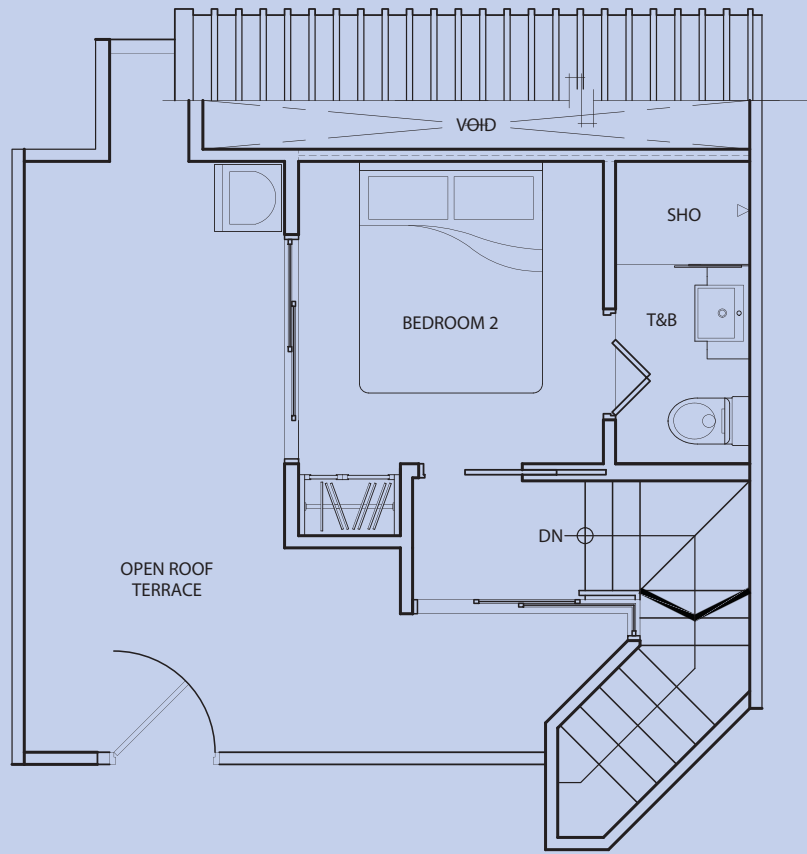

upper floor

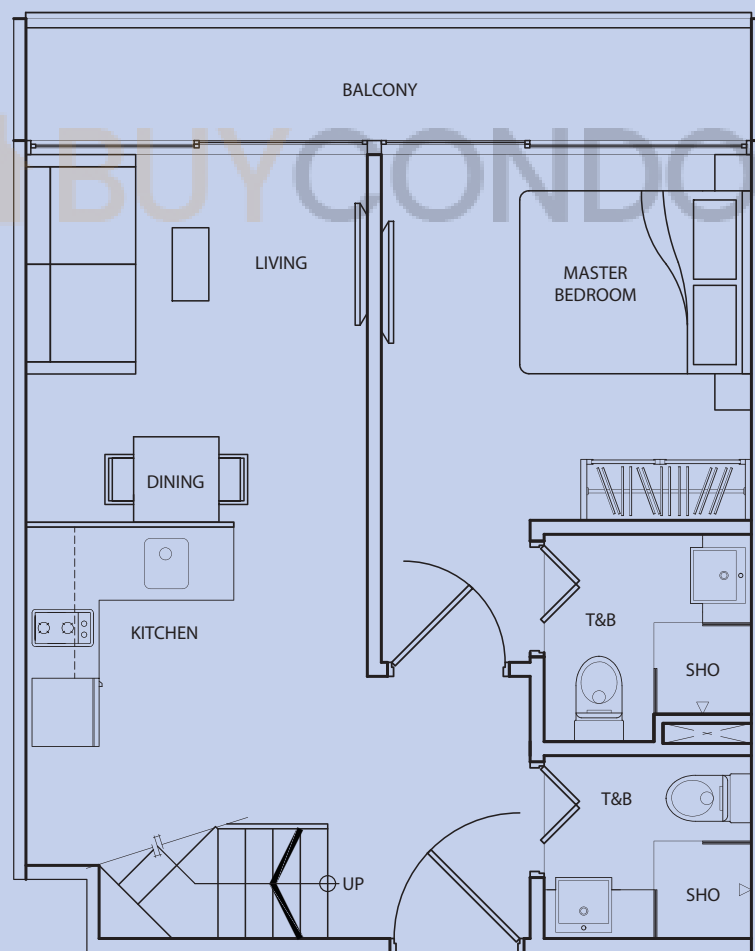

lower floor

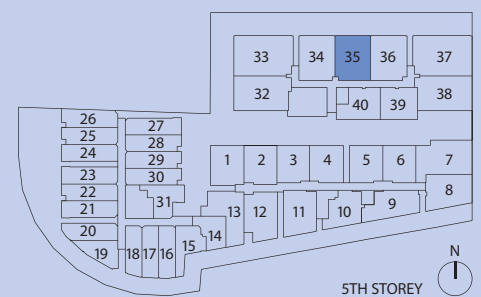

TYPE C-P5E

2 Bedroom  
+ 3 Bathroom  
79 sq m / 850 sq ft

#05-36

Inclusive of Balcony, Roof Terrace,  
AC Ledge

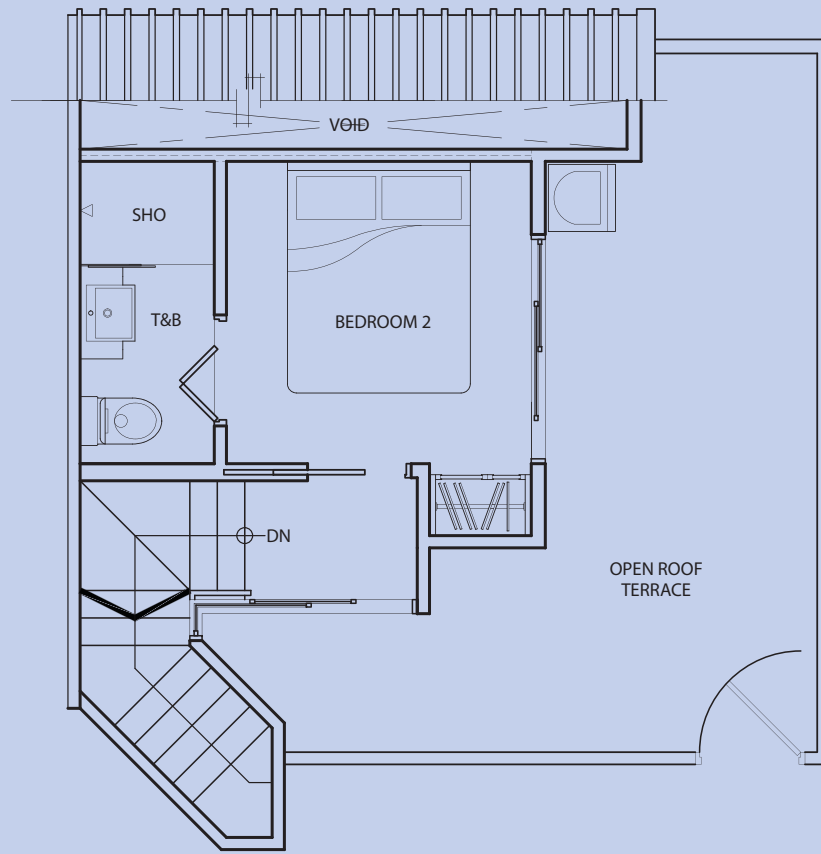

upper floor

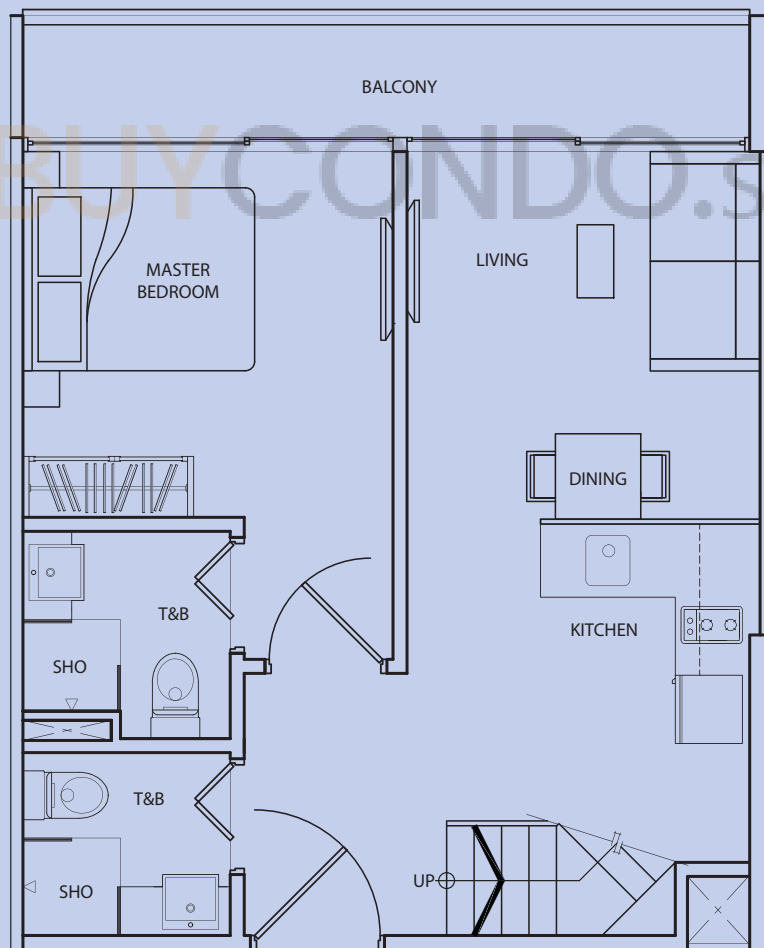

lower floor

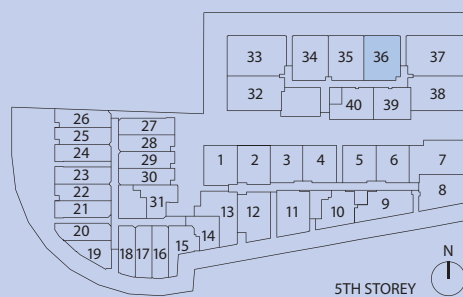

## TYPE C-P5F

3 Bedroom  
+ 3 Bathroom  
+ 1 Study Room  
117 sq m / 1259 sq ft

#05-37

Inclusive of Balcony, Roof Terrace,  
AC Ledge

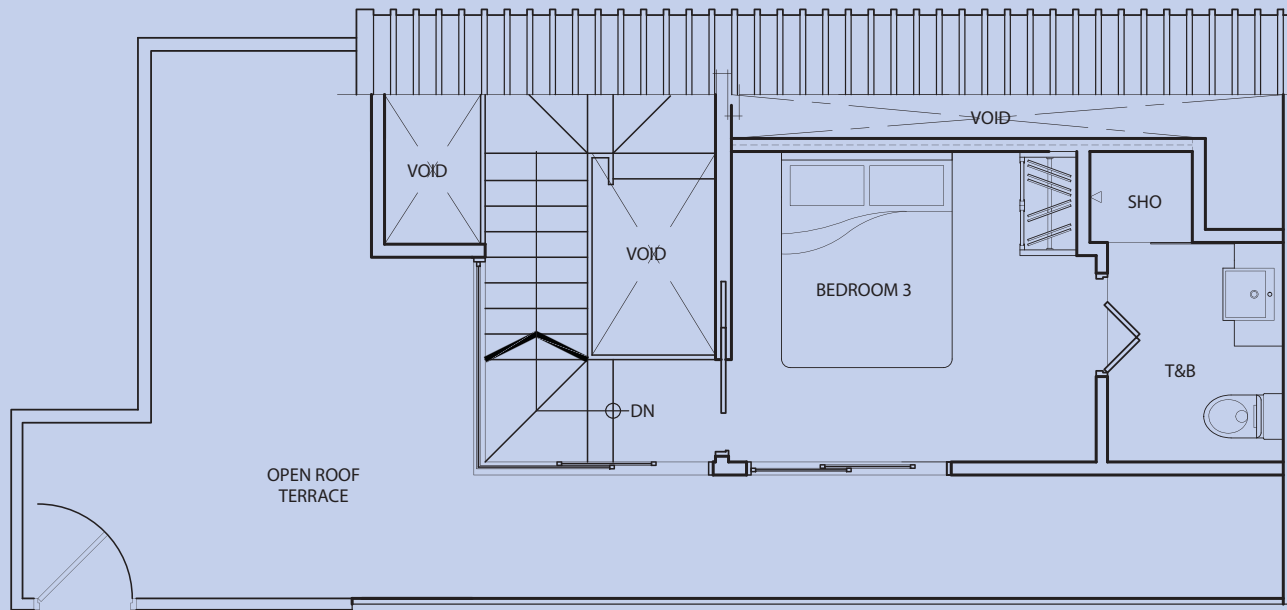

upper floor

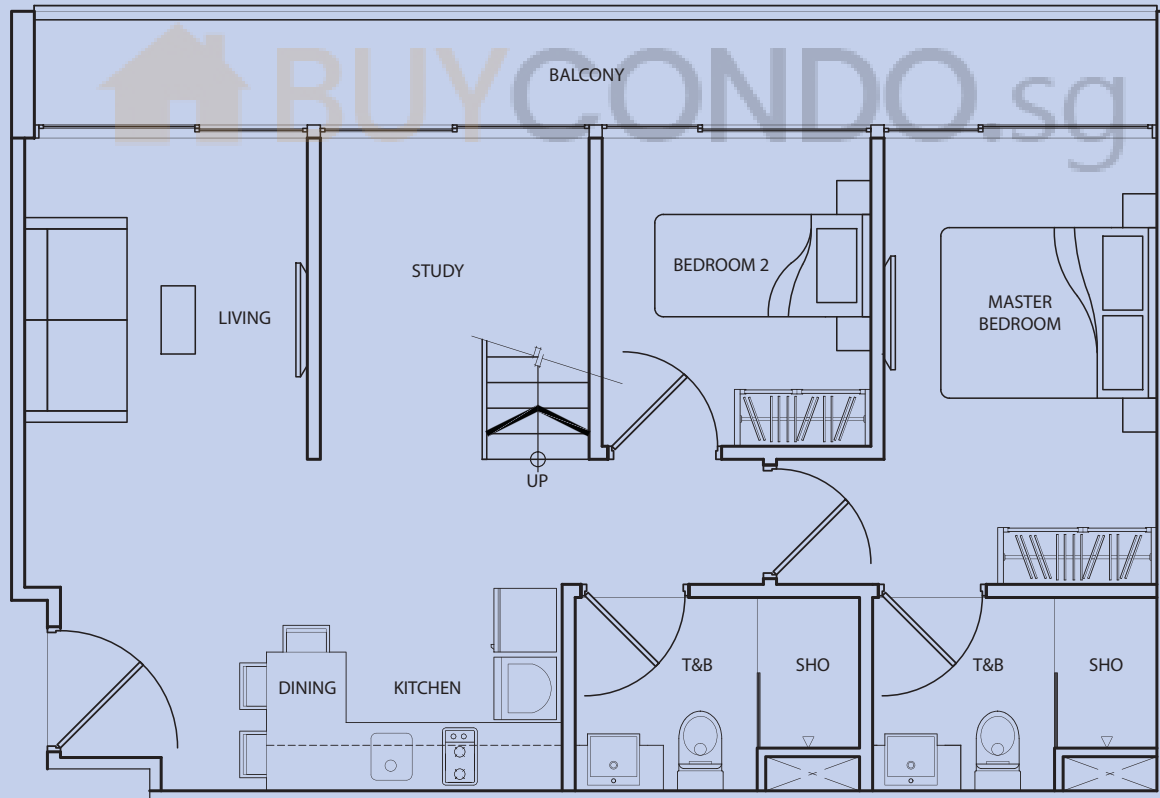

lower floor

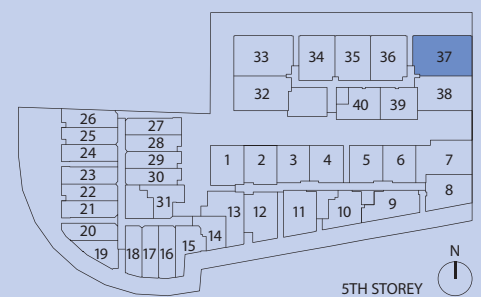

TYPE C-P5G

3 Bedroom  
 + 3 Bathroom  
 + 1 Study Room  
 103 sq m / 1109 sq ft

#05-38

Inclusive of Roof Terrace, AC Ledge

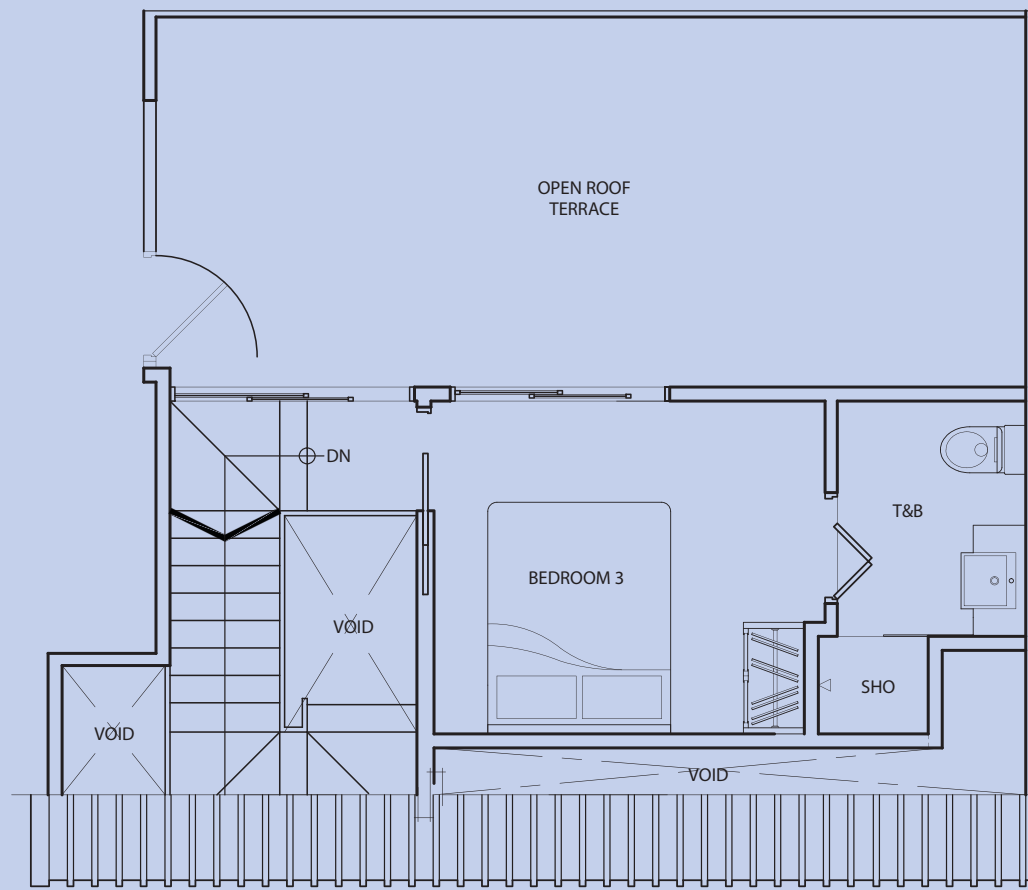

upper floor

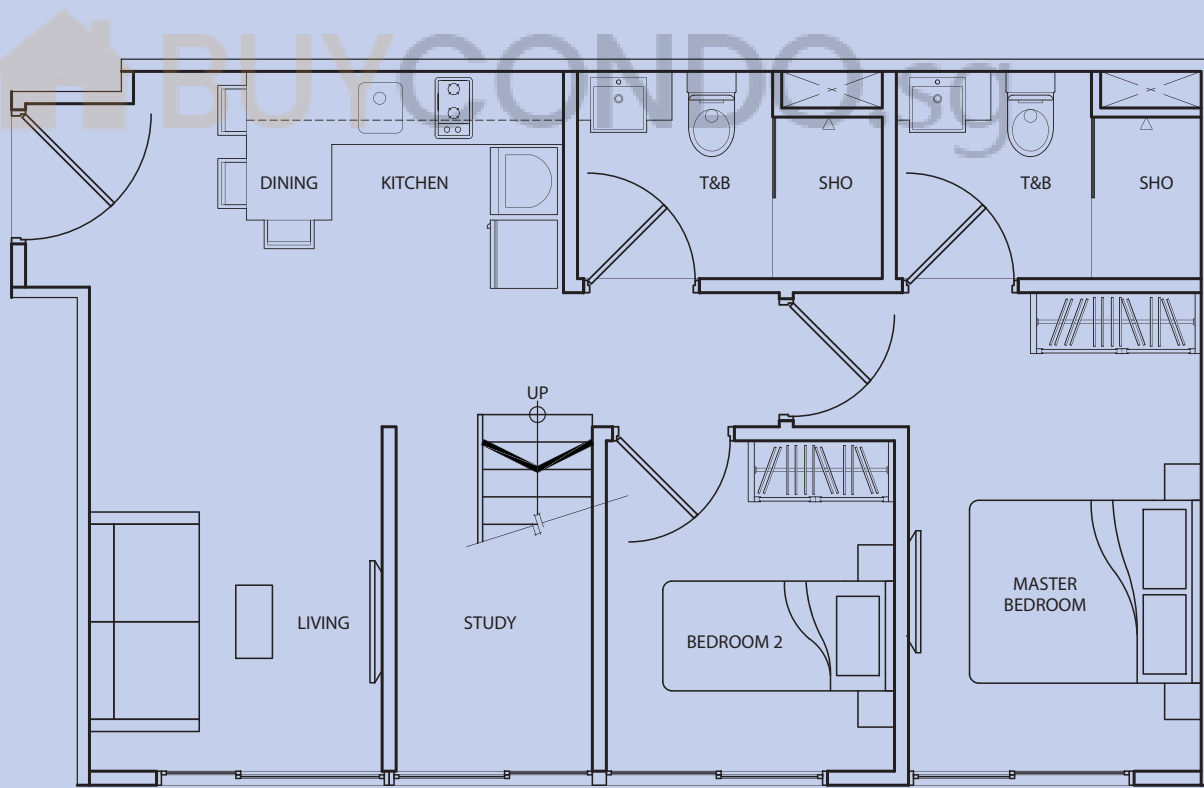

lower floor

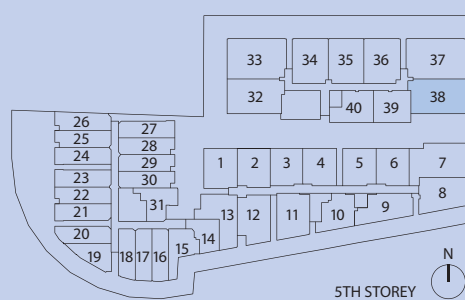

TYPE C-P5H

2 Bedroom  
+ 3 Bathroom  
75 sq m / 807 sq ft

#05-39

Inclusive of Roof Terrace, AC Ledge

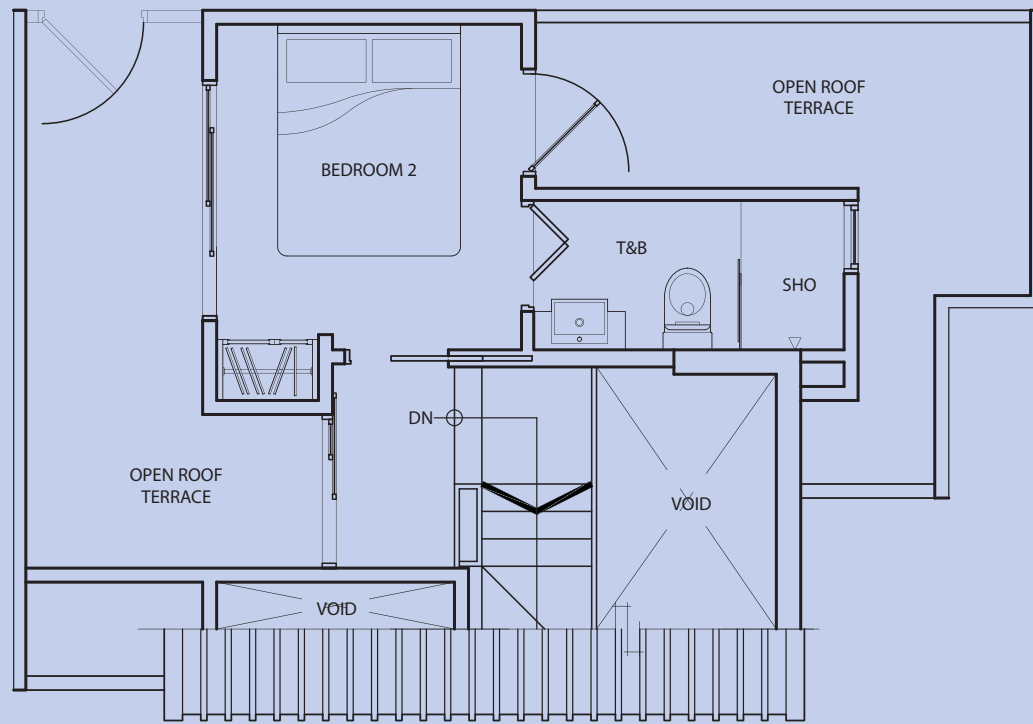

upper floor

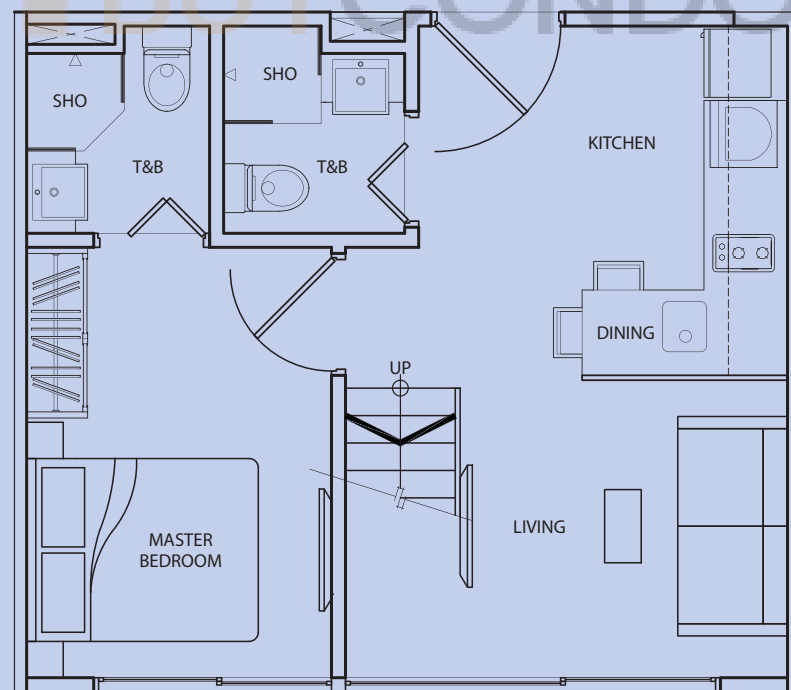

lower floor



BLIVCONDO.sg

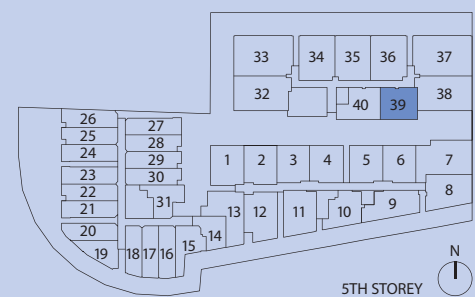

TYPE C-P5I

2 Bedroom  
+ 3 Bathroom  
67 sq m / 721 sq ft

#05-40

Inclusive of Roof Terrace, AC Ledge

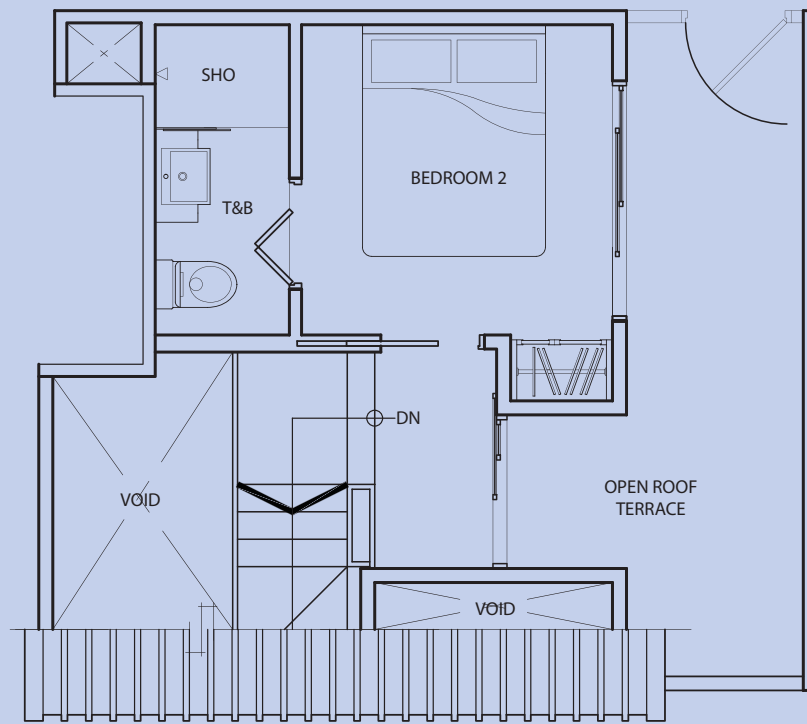

upper floor

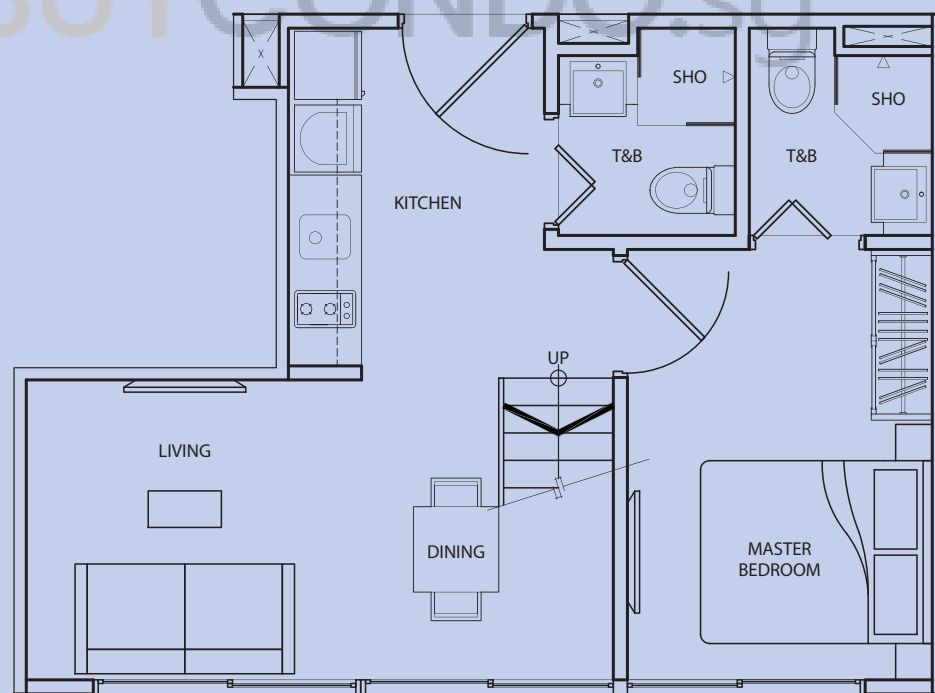

lower floor

