

1-Bedroom

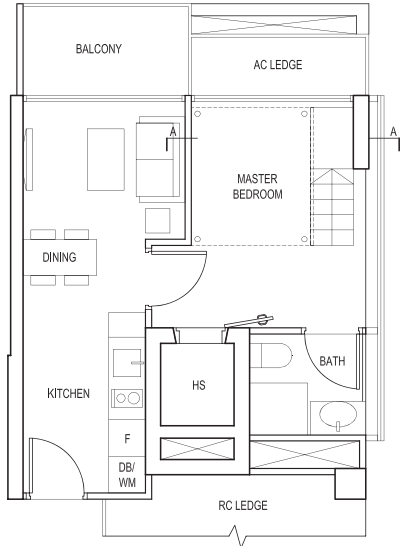

Type A1

- #10-06
- #11-06
- #12-06
- #13-06
- #16-06
- #17-06
- #18-06
- #19-06
- #20-06
- #21-06
- #22-06
- #23-06
- #26-06
- #27-06
- #28-06
- #29-06

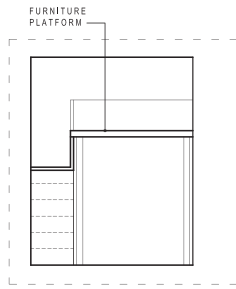

SECTION A-A

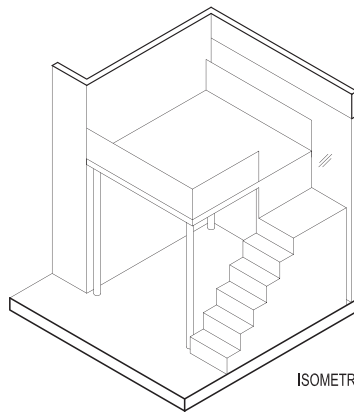

ISOMETRIC OF FURNITURE PLATFORM

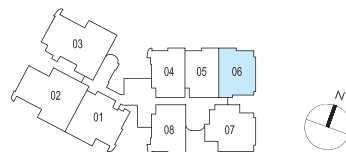

1-Bedroom

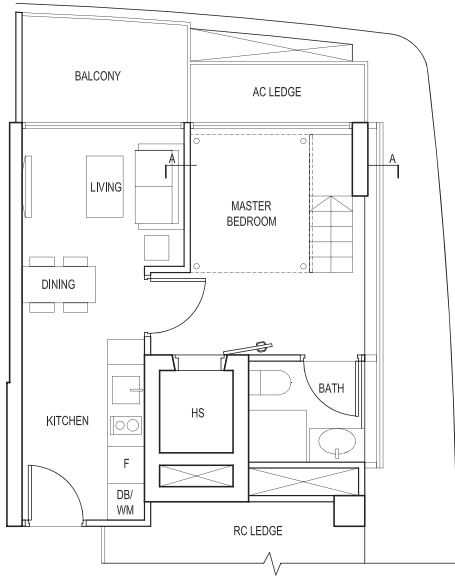

Type A1a

- #09-06
- #15-06
- #25-06

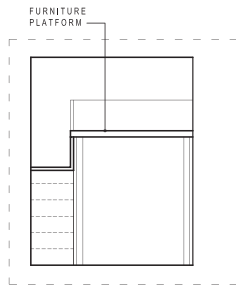

SECTION A-A

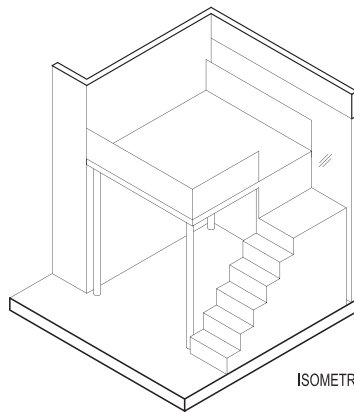

ISOMETRIC OF FURNITURE PLATFORM

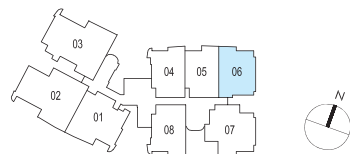

1+S-Bedroom

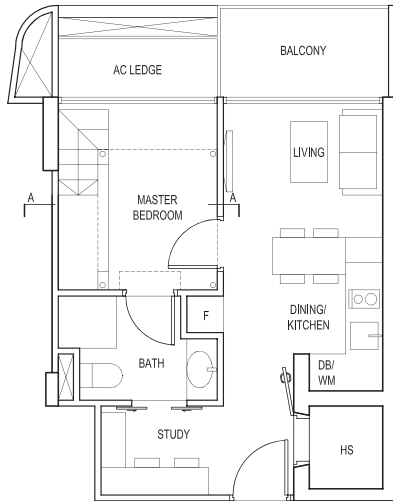

Type A2

- #10-04
- #11-04
- #12-04
- #13-04
- #16-04
- #17-04
- #18-04
- #19-04
- #20-04
- #21-04
- #22-04
- #23-04
- #26-04
- #27-04
- #28-04
- #29-04

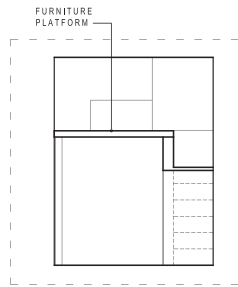

SECTION A-A

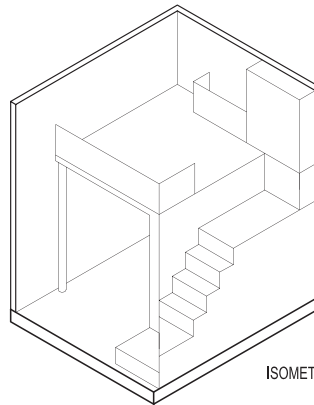

ISOMETRIC OF FURNITURE PLATFORM

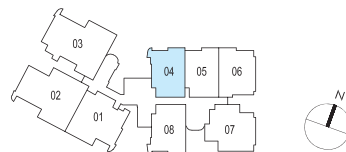

1+S-Bedroom

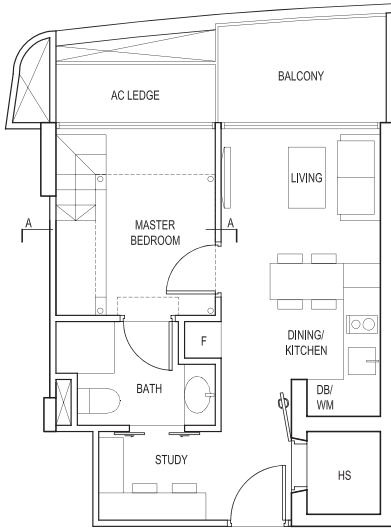

Type A2a

- #09-04
- #15-04
- #25-04

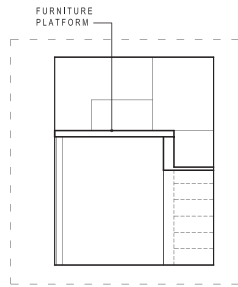

SECTION A-A

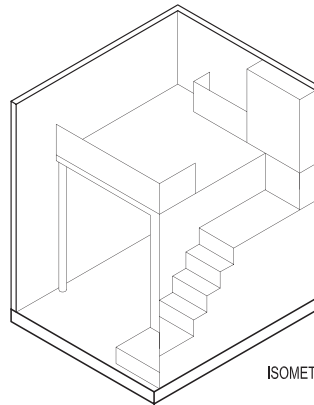

ISOMETRIC OF FURNITURE PLATFORM

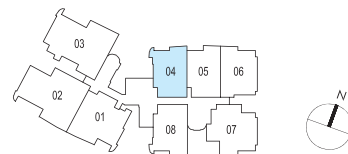

1+S-Bedroom

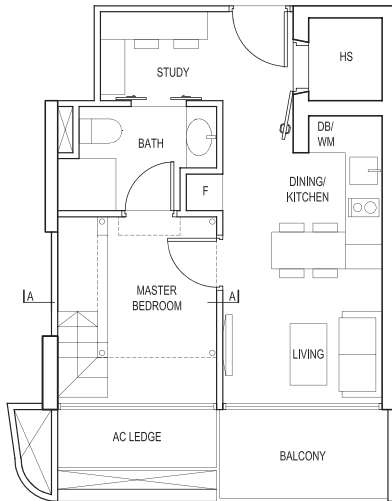

Type A3

- #10-08
- #11-08
- #12-08
- #13-08
- #16-08
- #17-08
- #18-08
- #19-08
- #20-08
- #21-08
- #22-08
- #23-08
- #26-08
- #27-08
- #28-08
- #29-08

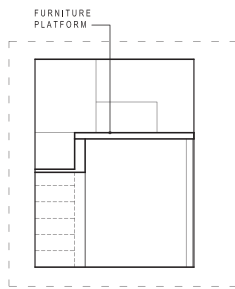

SECTION A-A

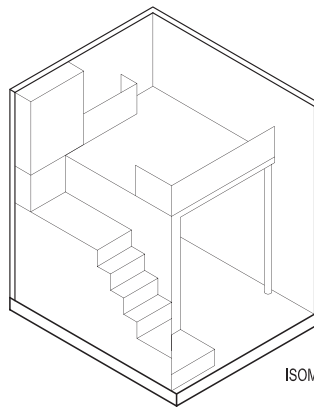

ISOMETRIC OF FURNITURE PLATFORM

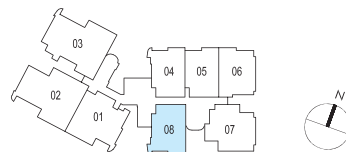

1+S-Bedroom

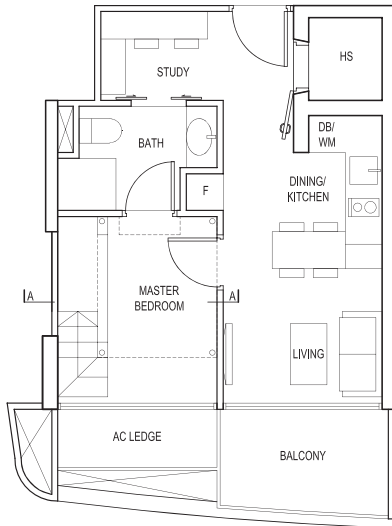

Type A3a

- #09-08
- #15-08
- #25-08

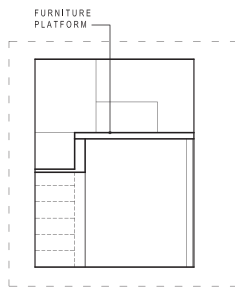

SECTION A-A

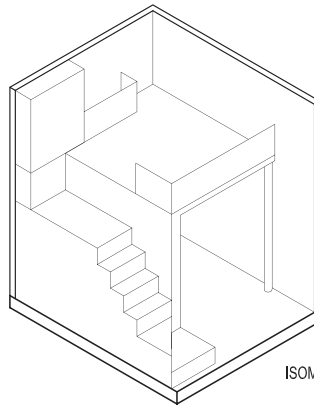

ISOMETRIC OF FURNITURE PLATFORM

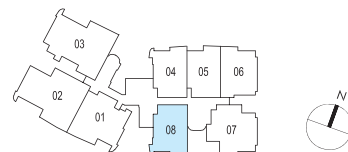

1+S-Bedroom

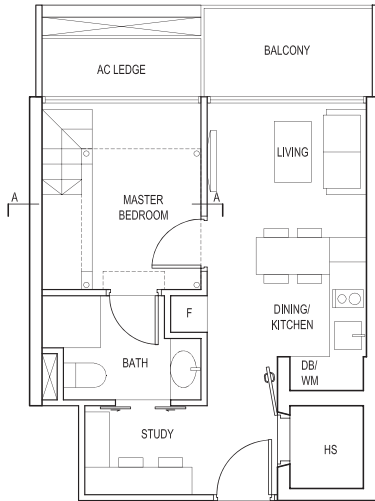

Type A4

- #10-05
- #11-05
- #12-05
- #13-05
- #16-05
- #17-05
- #18-05
- #19-05
- #20-05
- #21-05
- #22-05
- #23-05
- #26-05
- #27-05
- #28-05
- #29-05

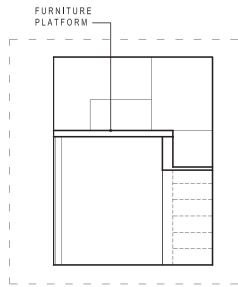

SECTION A-A

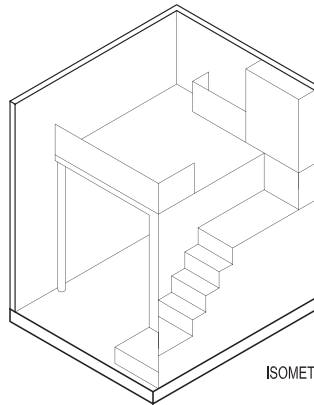

ISOMETRIC OF FURNITURE PLATFORM

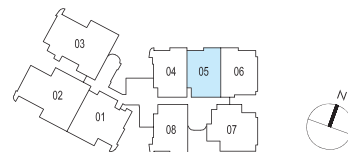

1+S-Bedroom

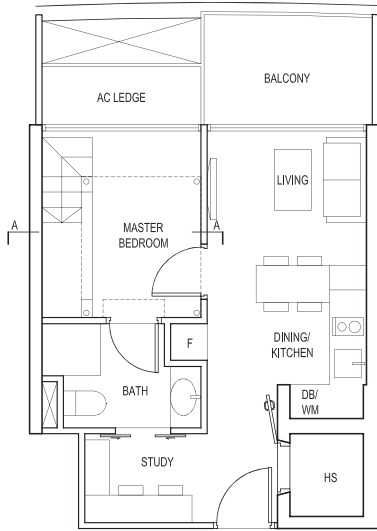

Type A4a

- #09-05
- #15-05
- #25-05

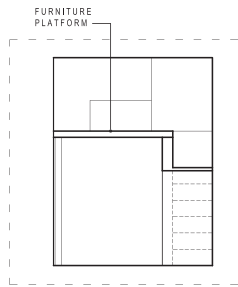

SECTION A-A

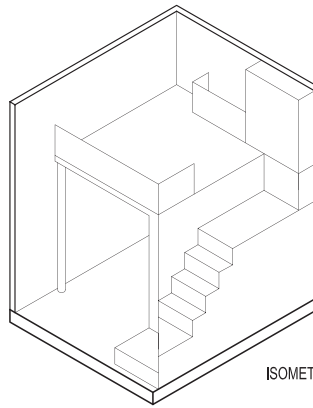

ISOMETRIC OF FURNITURE PLATFORM

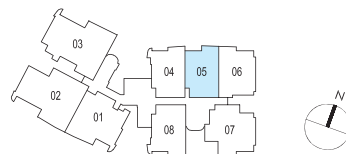

1+S-Bedroom

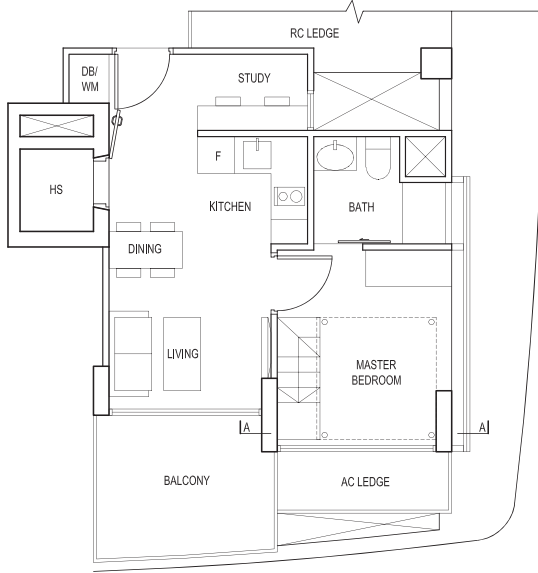

Type A5

#09-07

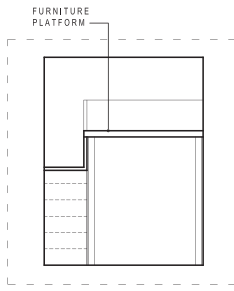

SECTION A-A

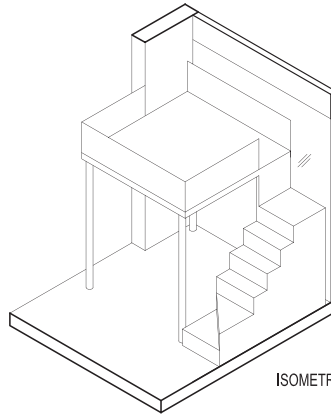

ISOMETRIC OF FURNITURE PLATFORM

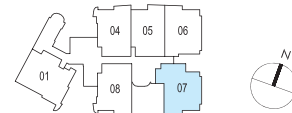

2-Bedroom

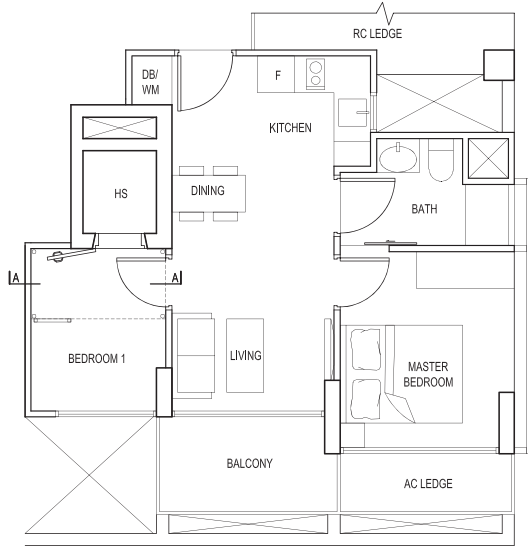

Type B1

- #10-07
- #11-07
- #12-07
- #13-07
- #16-07
- #17-07
- #18-07
- #19-07
- #20-07
- #21-07
- #22-07
- #23-07
- #26-07
- #27-07
- #28-07
- #29-07

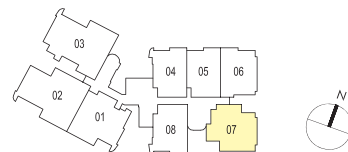
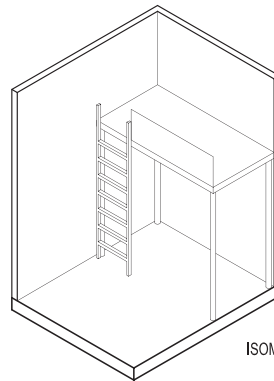
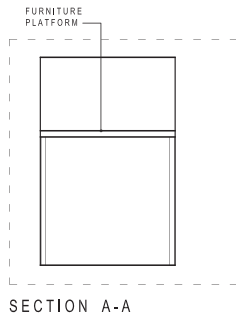

2-Bedroom

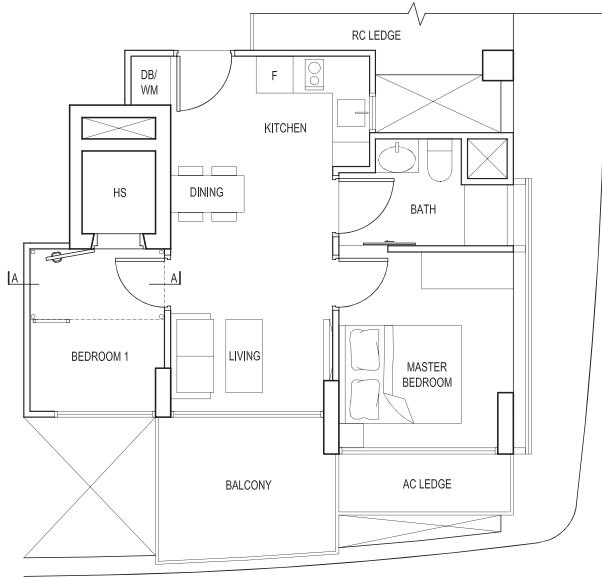

Type B1a

#15-07
#25-07

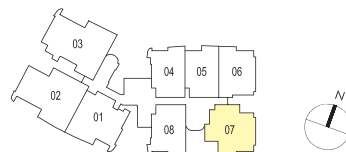
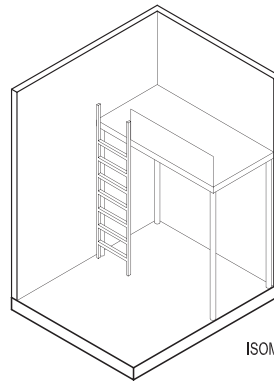
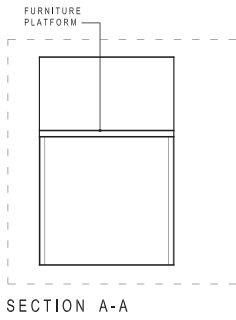

2-Bedroom

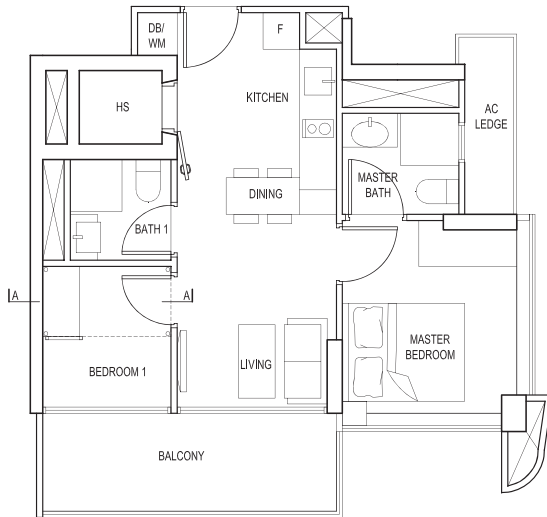

Type B2

- #10-01
- #11-01
- #12-01
- #13-01
- #16-01
- #17-01
- #18-01
- #19-01
- #20-01
- #21-01
- #22-01
- #23-01
- #26-01
- #27-01
- #28-01
- #29-01

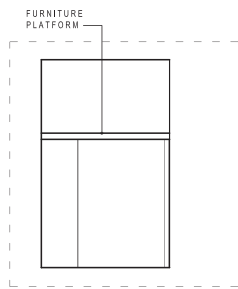

SECTION A-A

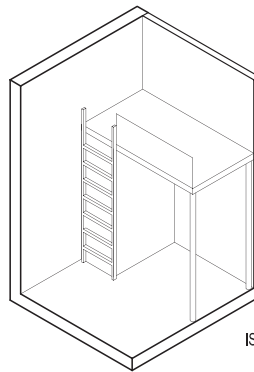

ISOMETRIC OF FURNITURE PLATFORM

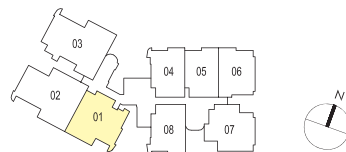

2-Bedroom

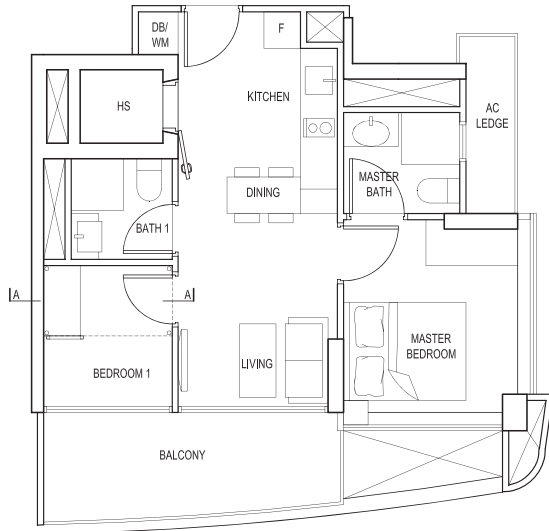

Type B2a

#15-01
#25-01

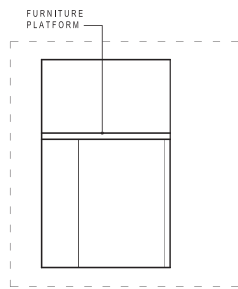

SECTION A-A

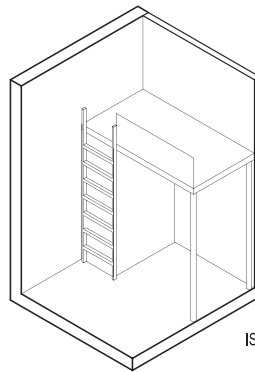

ISOMETRIC OF FURNITURE PLATFORM

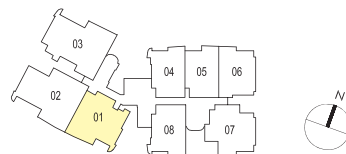

2-Bedroom

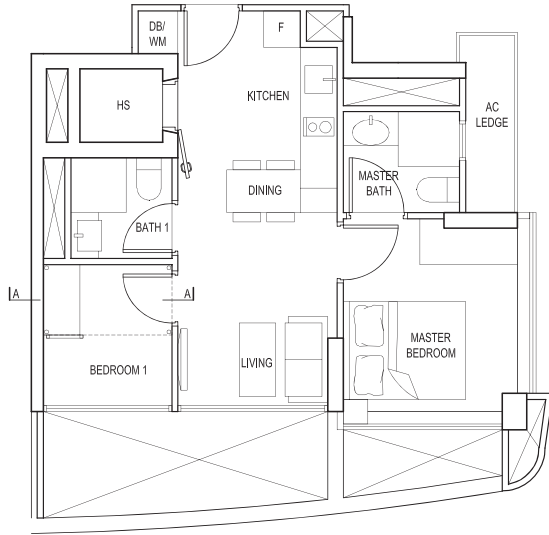

Type B2b

#09-01

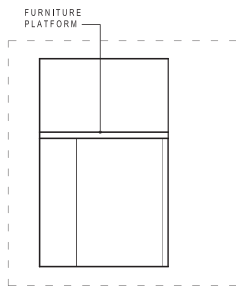

SECTION A-A

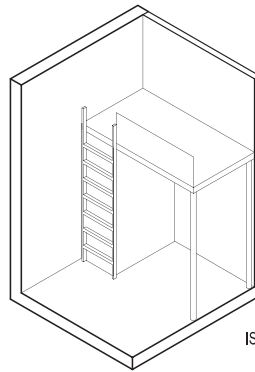

ISOMETRIC OF FURNITURE PLATFORM



2-Bedroom

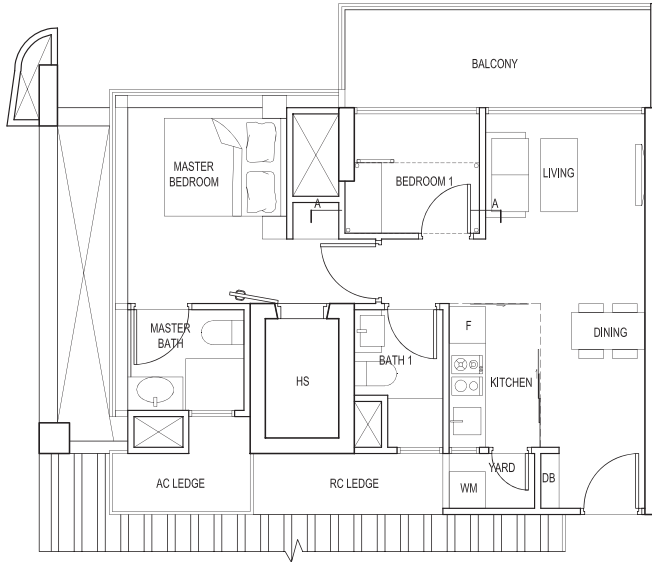

Type B3

- #10-03
- #11-03
- #12-03
- #13-03

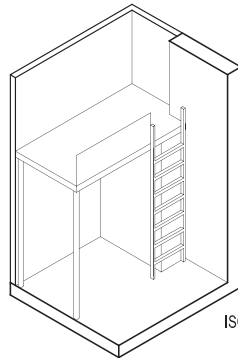
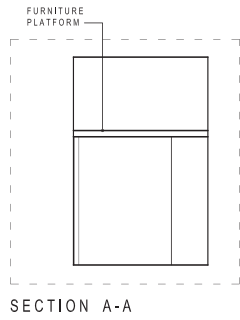

ISOMETRIC OF FURNITURE PLATFORM

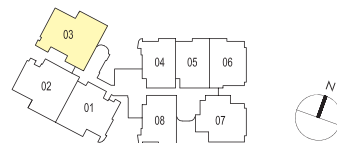

2-Bedroom

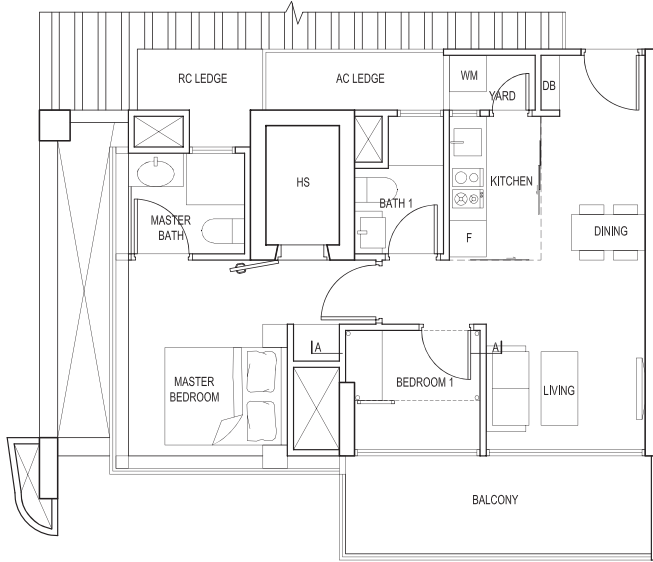

Type B4

- #10-02
- #11-02
- #12-02
- #13-02

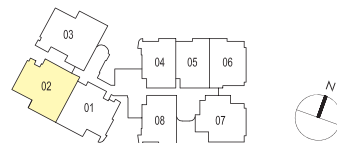
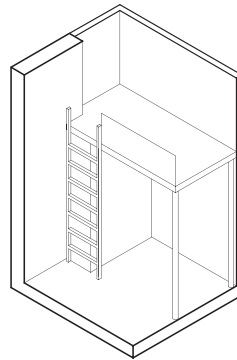
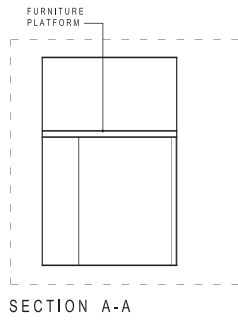

3-Bedroom

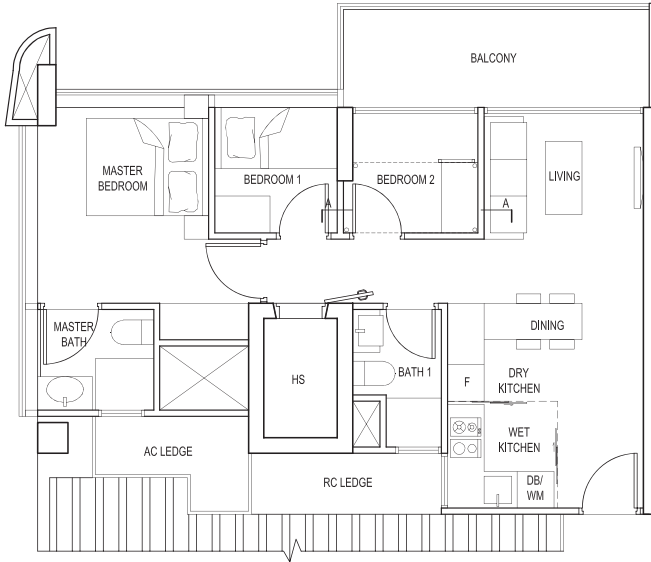

Type C1

- #16-03 #20-03
- #17-03 #21-03
- #18-03 #22-03
- #19-03 #23-03

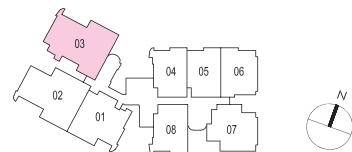
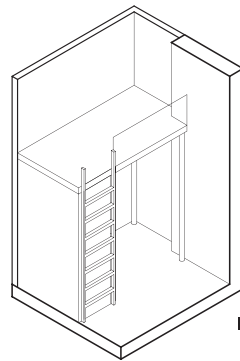
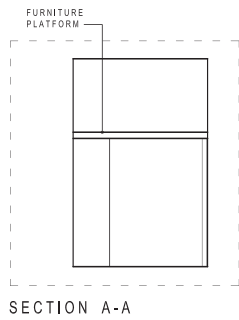

3-Bedroom

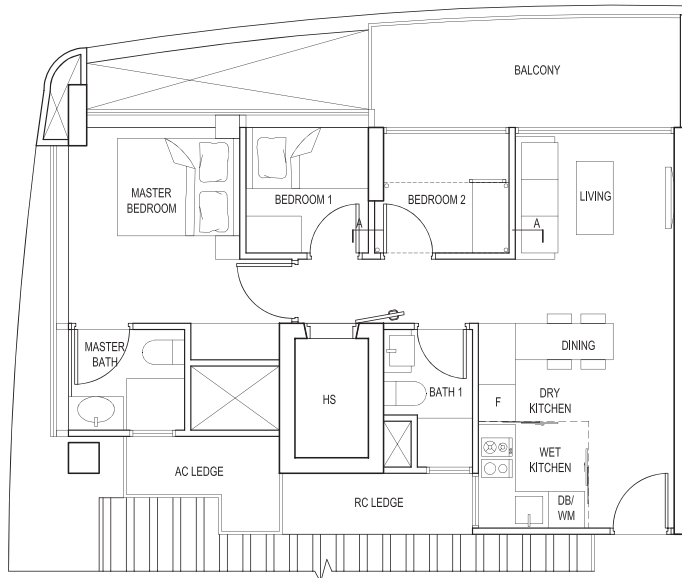

Type C1a

#15-03

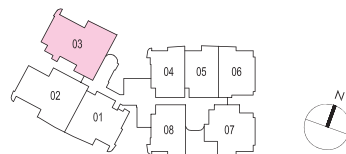
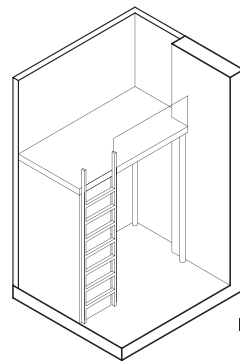
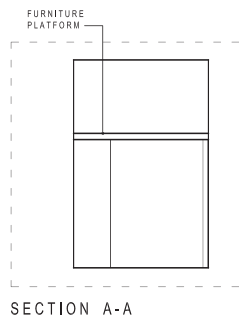

3-Bedroom

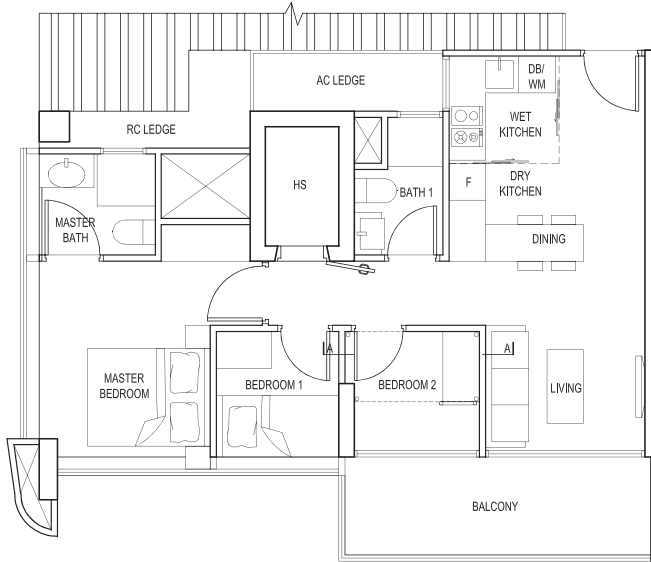

Type C2

- #16-02 #20-02
- #17-02 #21-02
- #18-02 #22-02
- #19-02 #23-02

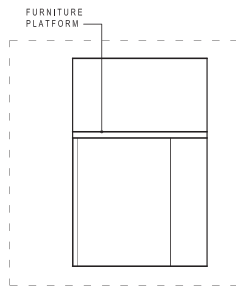

SECTION A-A

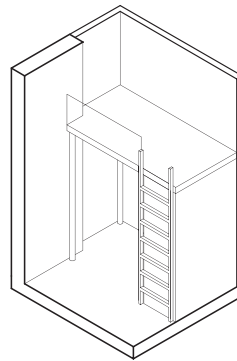

ISOMETRIC OF FURNITURE PLATFORM

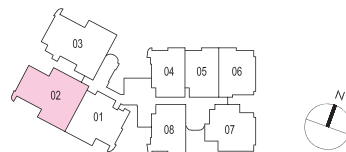

3-Bedroom

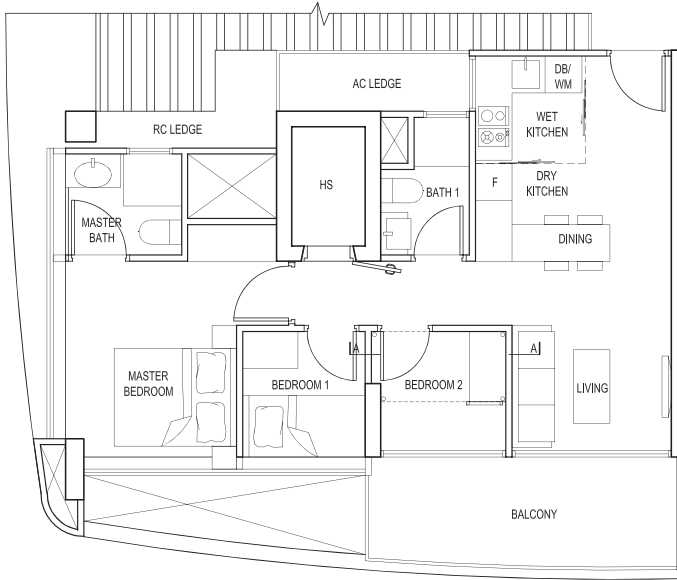

Type C2a

#15-02

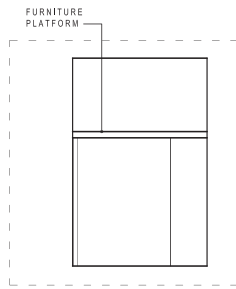

SECTION A-A

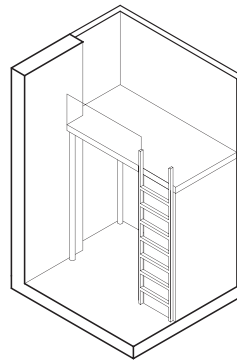

ISOMETRIC OF FURNITURE PLATFORM



3-Bedroom

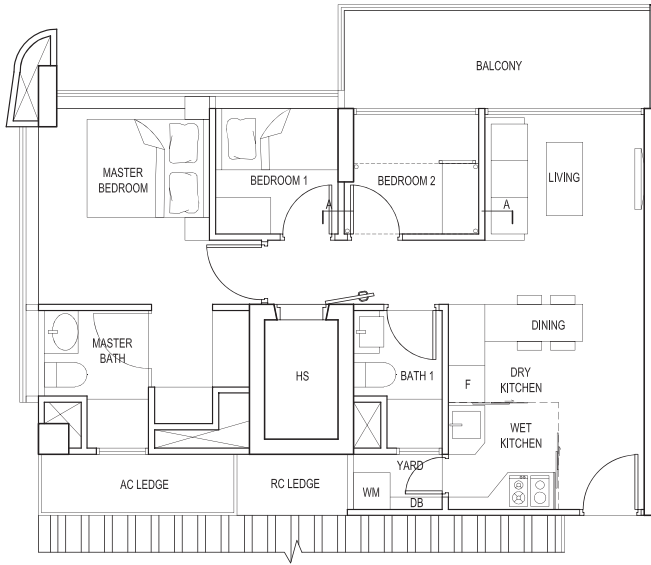

Type C3

- #26-03
- #27-03
- #28-03
- #29-03

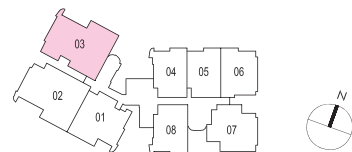
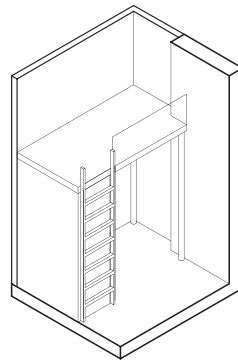
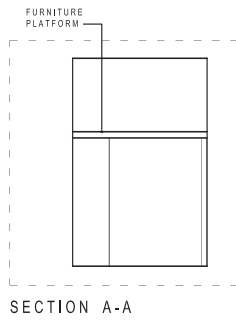

3-Bedroom

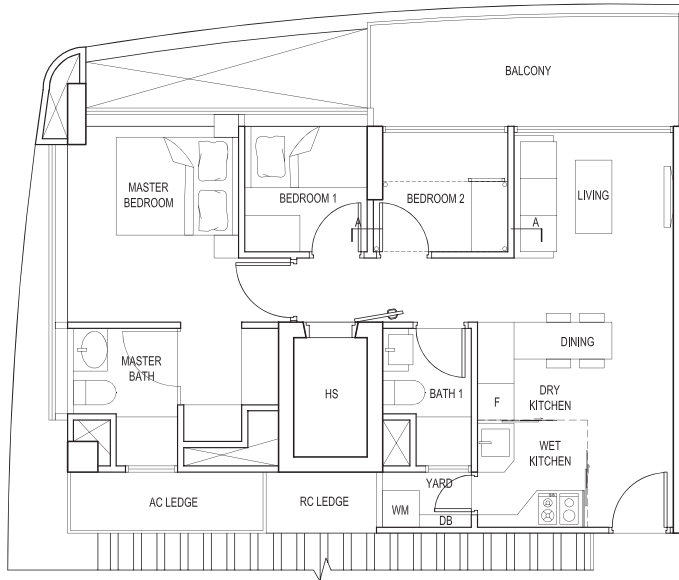

Type C3a

#25-03

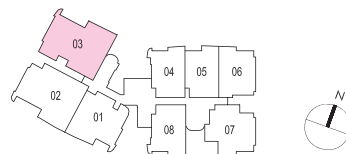
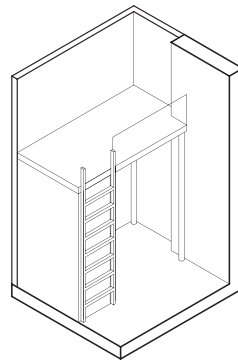
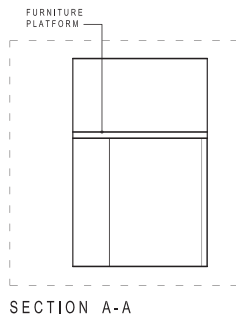

3-Bedroom

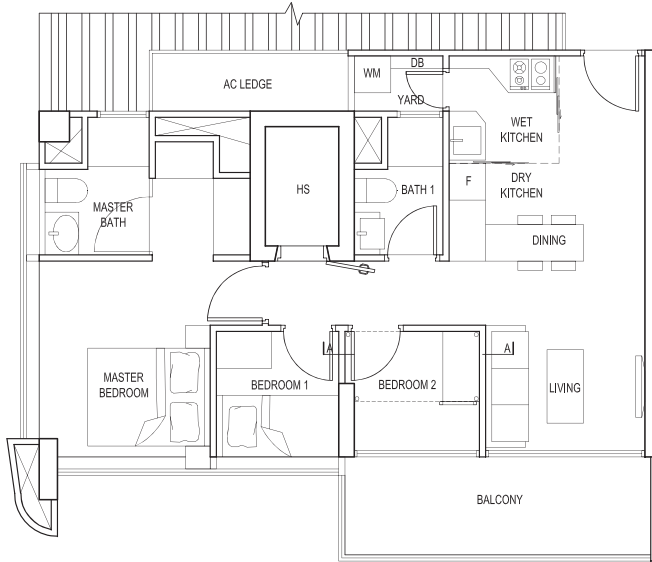

Type C4

- #26-02
- #27-02
- #28-02
- #29-02

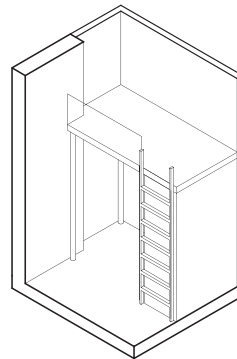
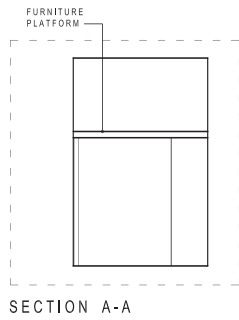

3-Bedroom

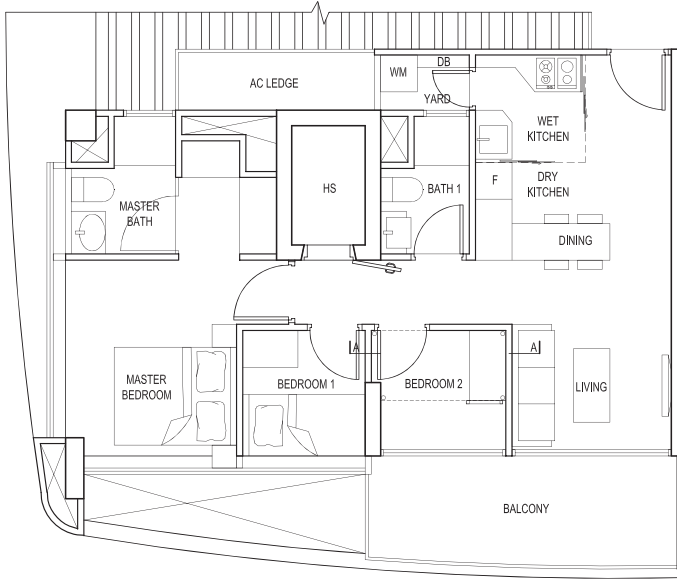

Type C4a

#25-02

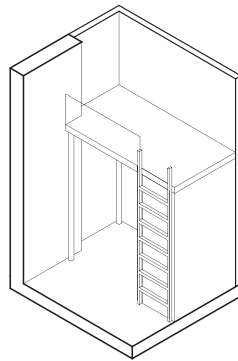
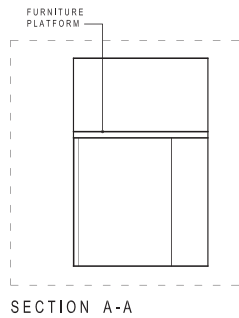

ISOMETRIC OF FURNITURE PLATFORM



2-Bedroom Duplex

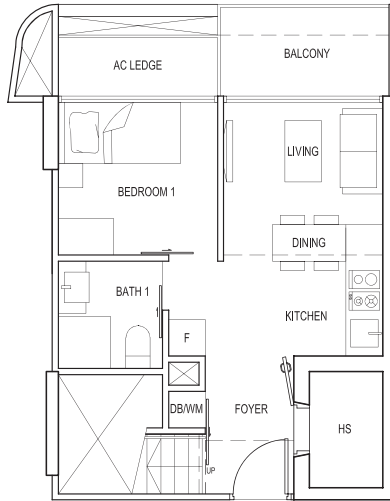

Type D1

- #30-04
- #32-04
- #34-04

LOWER FLOOR

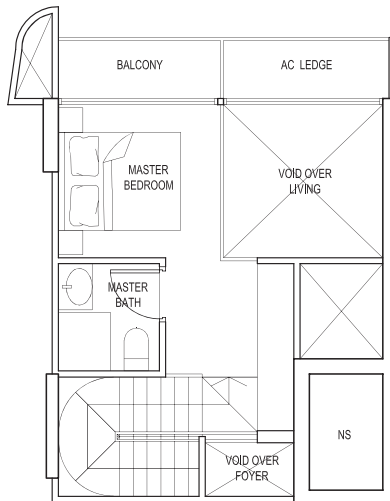

UPPER FLOOR

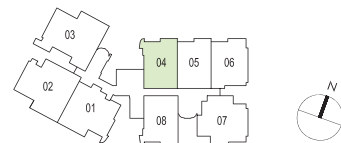

2-Bedroom Duplex

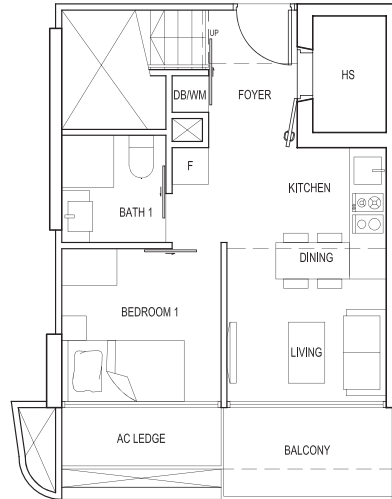

Type D2

- #30-08
- #32-08
- #34-08

LOWER FLOOR

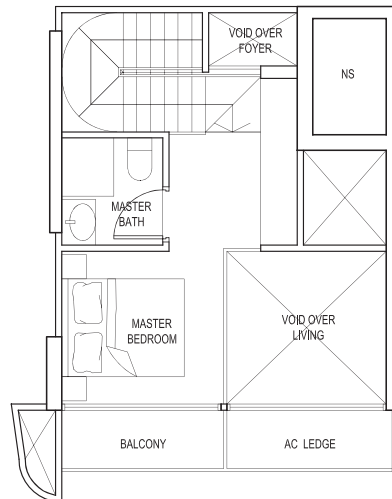

UPPER FLOOR

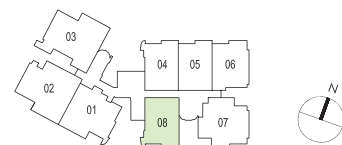

2-Bedroom Duplex

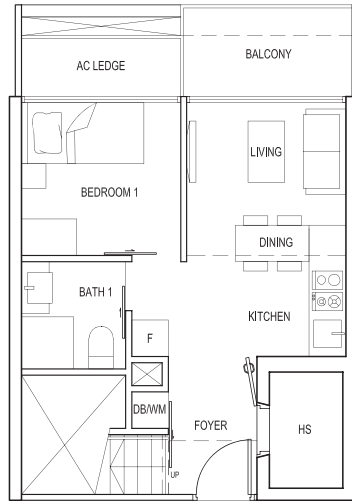

Type D3

- #30-05
- #32-05
- #34-05

LOWER FLOOR

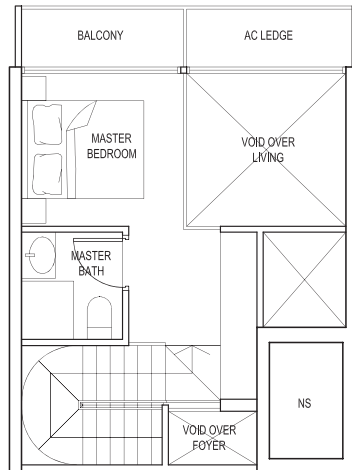

UPPER FLOOR

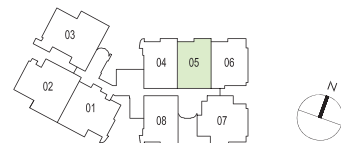

2-Bedroom Duplex

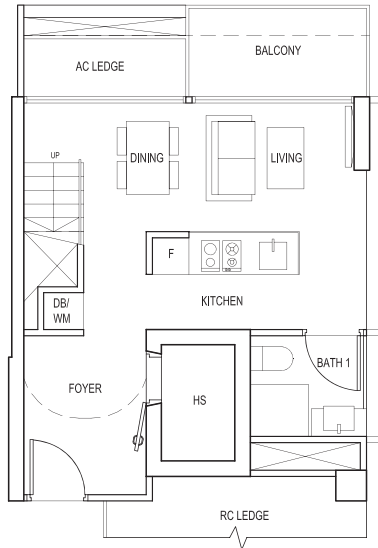

Type D4

- #30-06
- #32-06
- #34-06

LOWER FLOOR

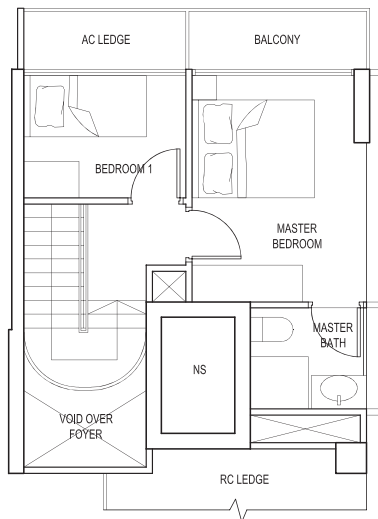

UPPER FLOOR

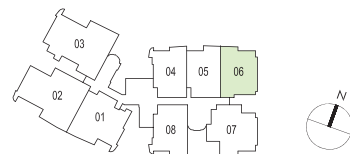

3-Bedroom Duplex

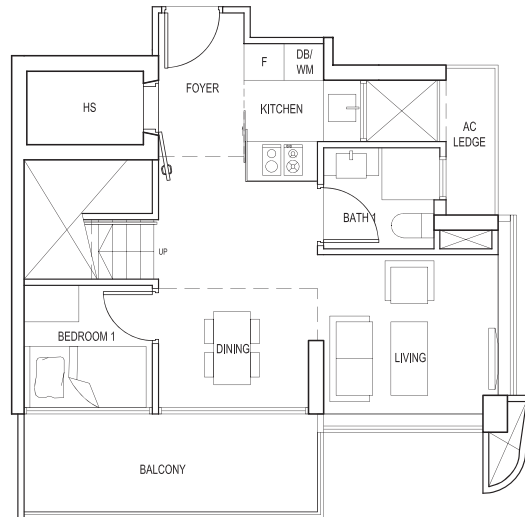

Type E1

- #30-01
- #32-01
- #34-01

LOWER FLOOR

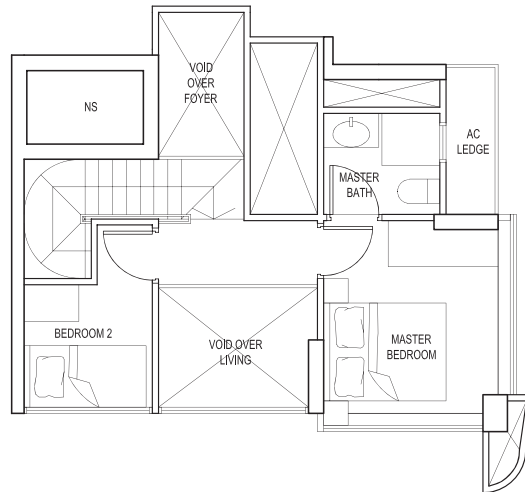

UPPER FLOOR

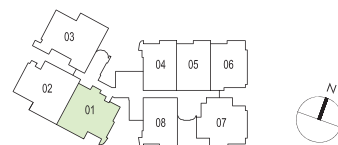

3-Bedroom Duplex

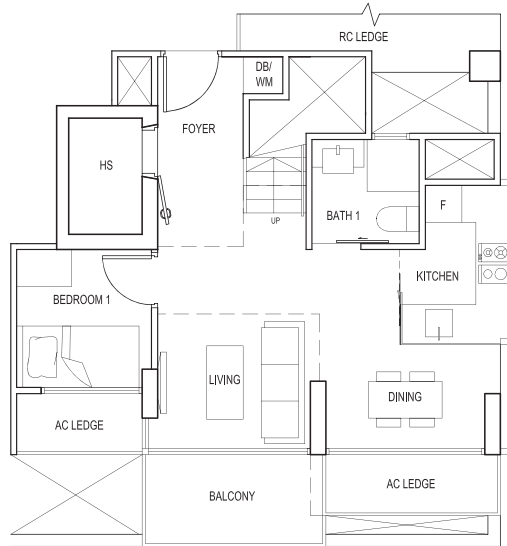

Type E2

- #30-07
- #32-07
- #34-07

LOWER FLOOR

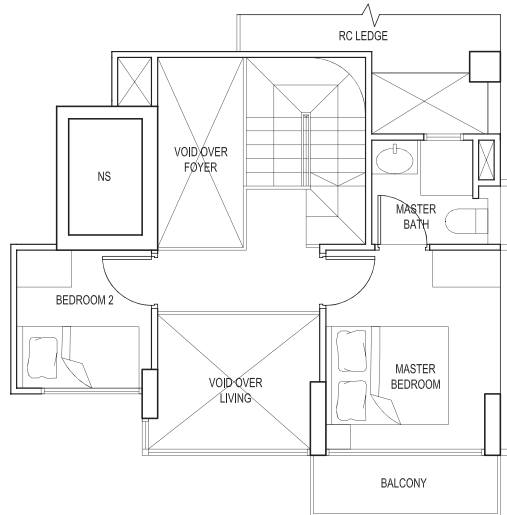

UPPER FLOOR

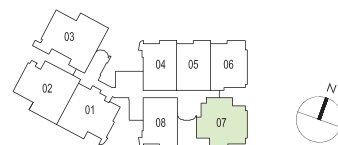

3-Bedroom Duplex

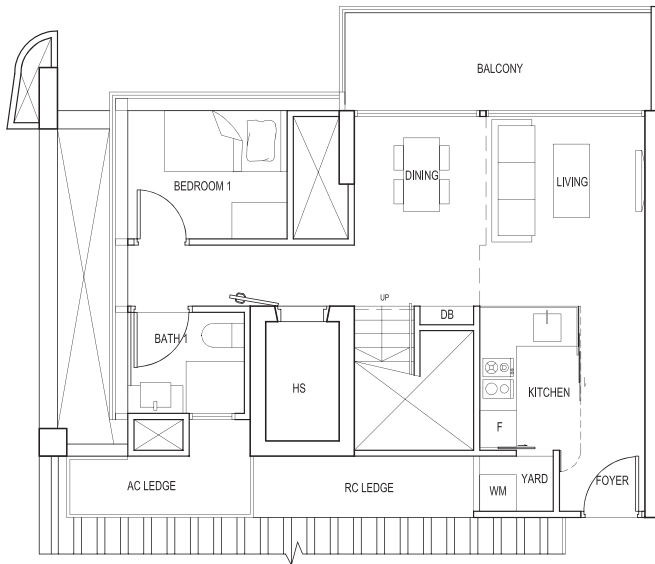

LOWER FLOOR

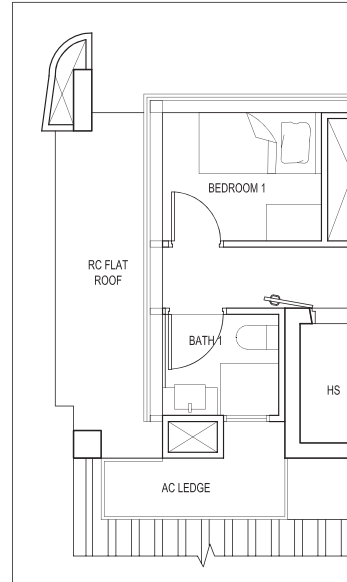

Applicable to #30-03 only.

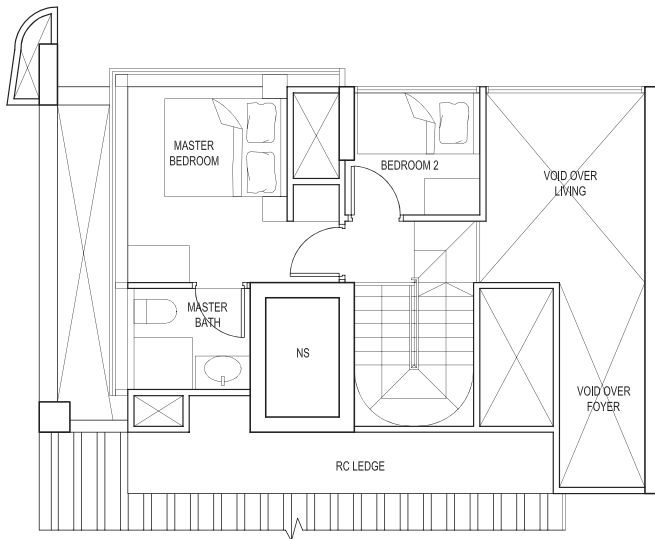

UPPER FLOOR

Type E3

- #30-03
- #32-03
- #34-03



3-Bedroom Duplex

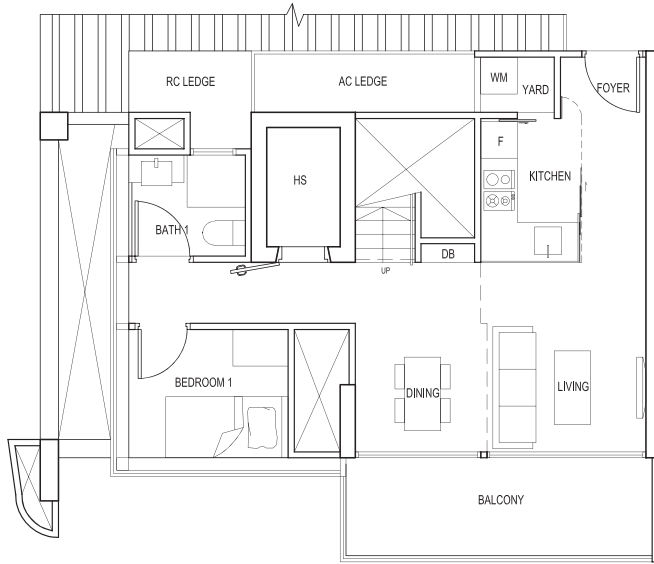

LOWER FLOOR

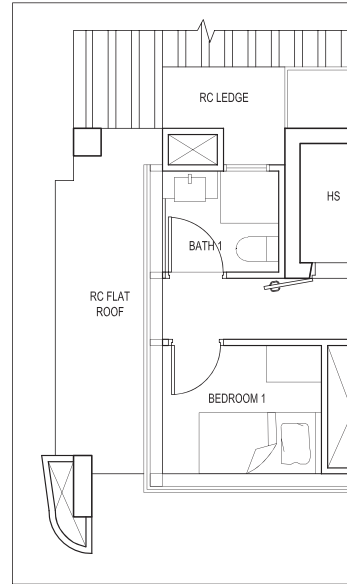

Applicable to #30-02 only.

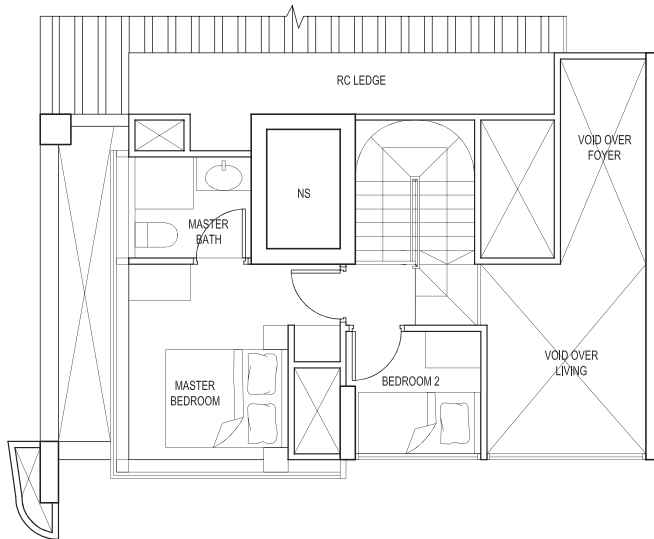

UPPER FLOOR

Type E4

- #30-02
- #32-02
- #34-02

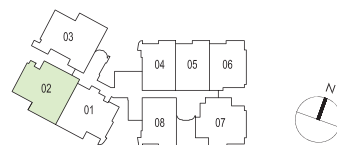

2-Bedroom Duplex + PES

Type F1

#05-04

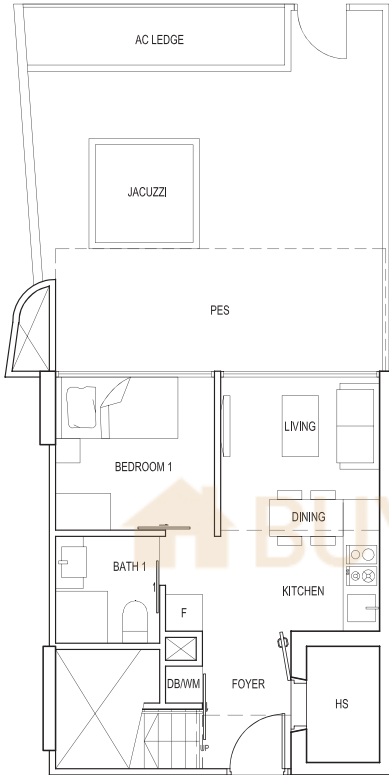

LOWER FLOOR

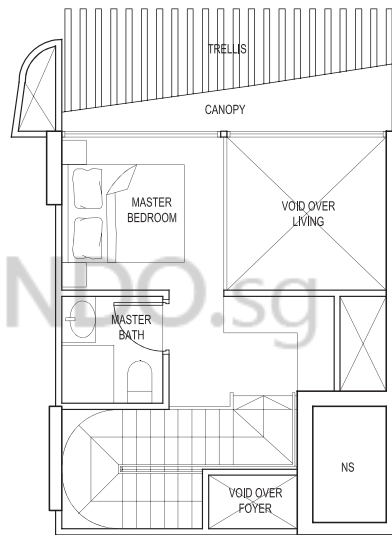

UPPER FLOOR

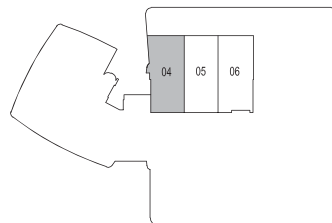

2-Bedroom Duplex + PES

Type F2

#05-05

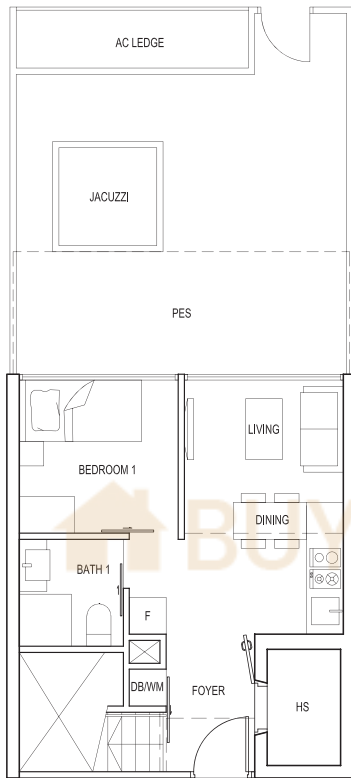

LOWER FLOOR

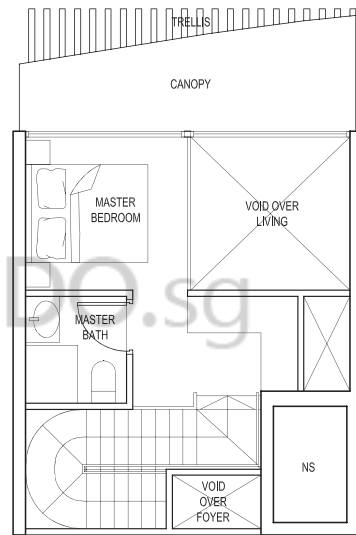

UPPER FLOOR

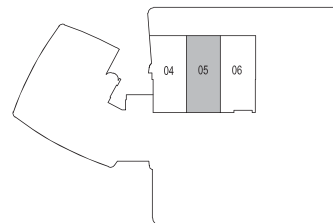

2-Bedroom Duplex + PES

Type F3

#05-06

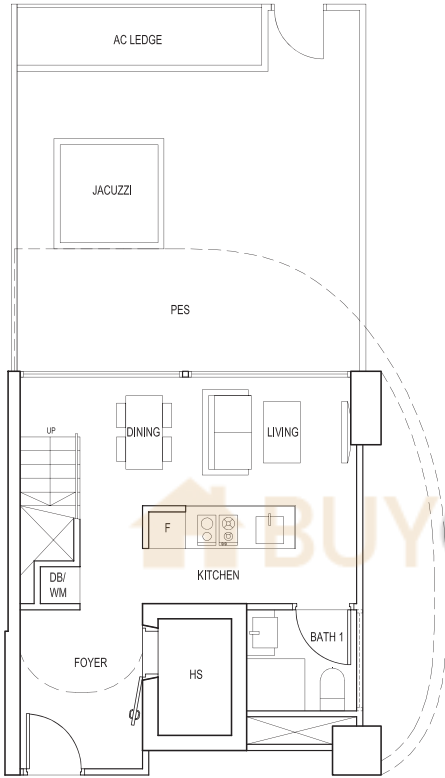

LOWER FLOOR

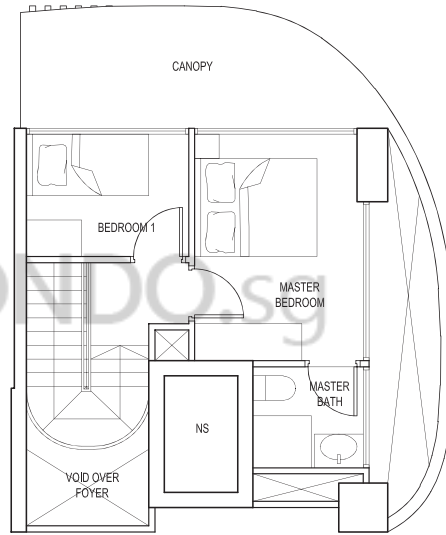

UPPER FLOOR

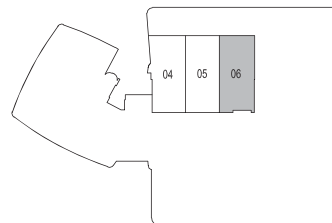

2-Bedroom Penthouse

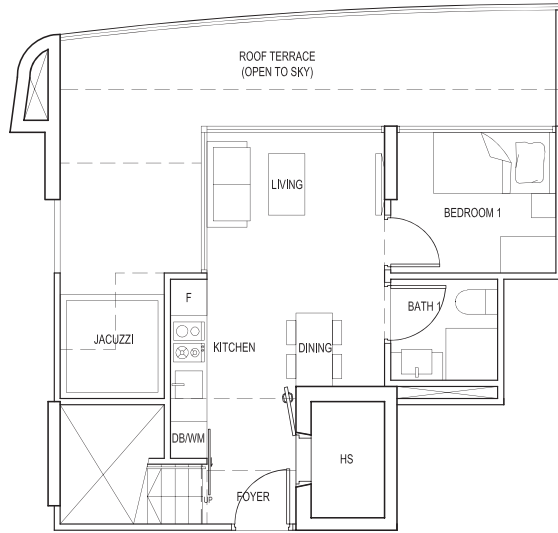

Type P1

#36-04

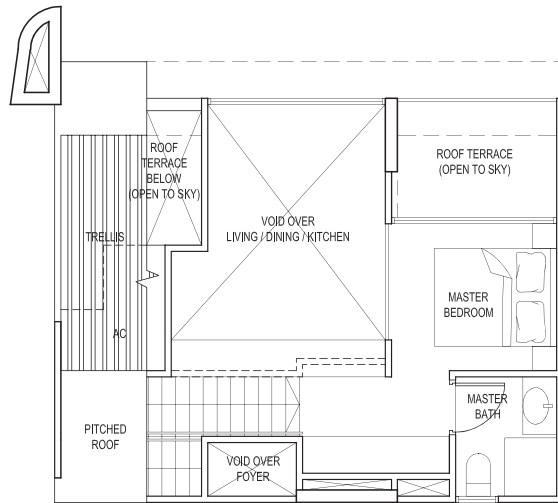

UPPER FLOOR

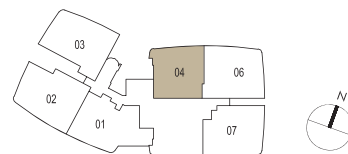

2-Bedroom Penthouse

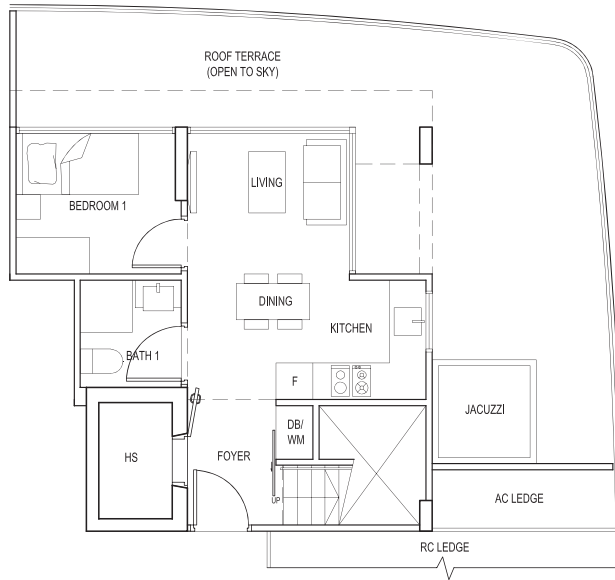

Type P2

#36-06

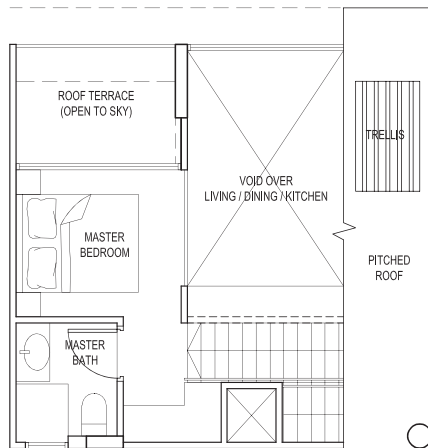

UPPER FLOOR



2-Bedroom Penthouse

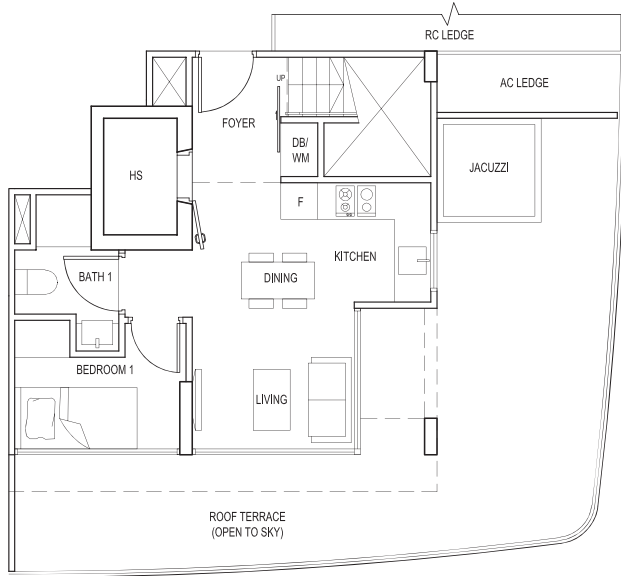

Type P3

#36-07

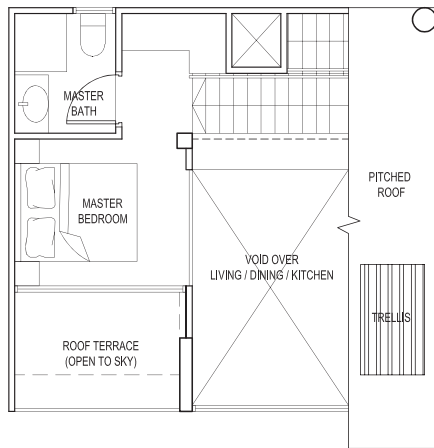

UPPER FLOOR

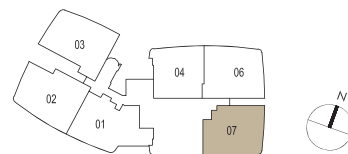

2-Bedroom Penthouse

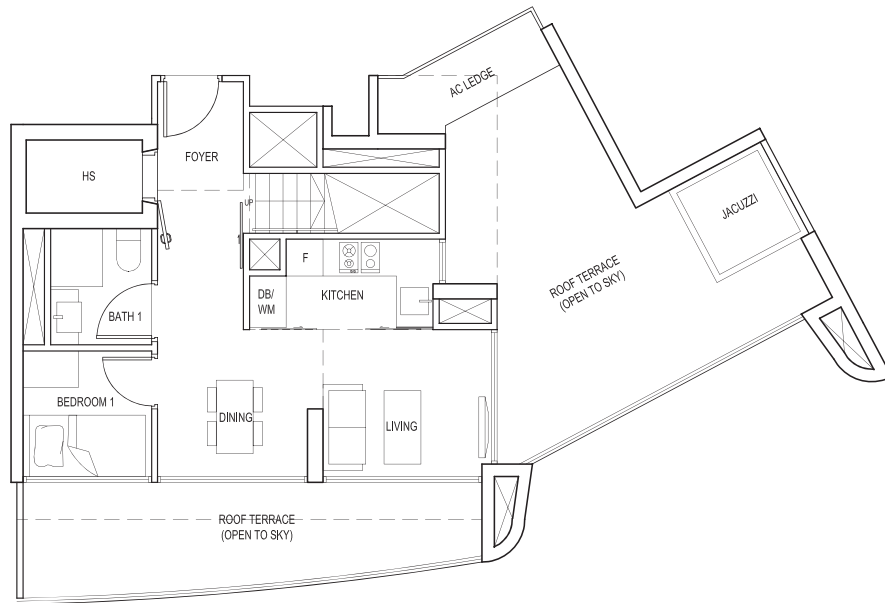

LOWER FLOOR 

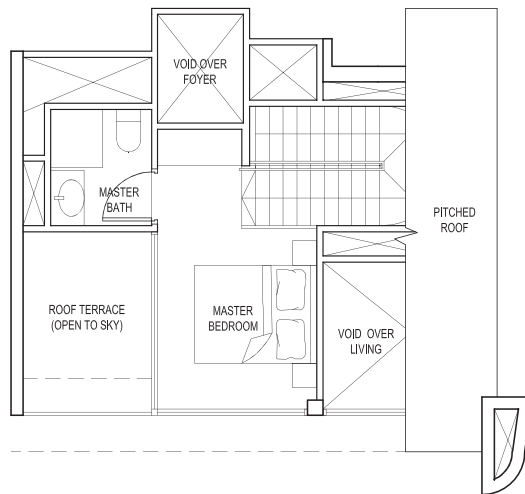

UPPER FLOOR

Type P4

#36-01

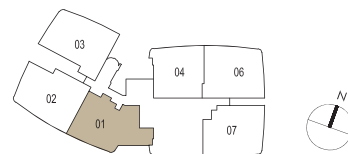

3-Bedroom Penthouse

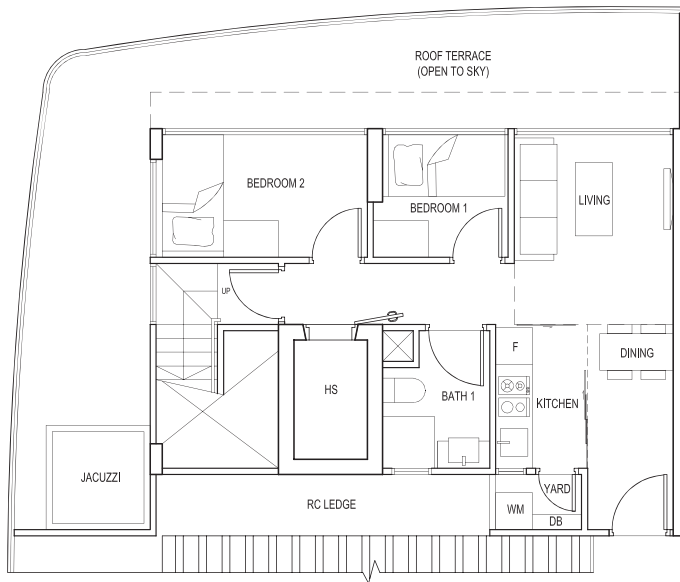

Type P5

#36-03

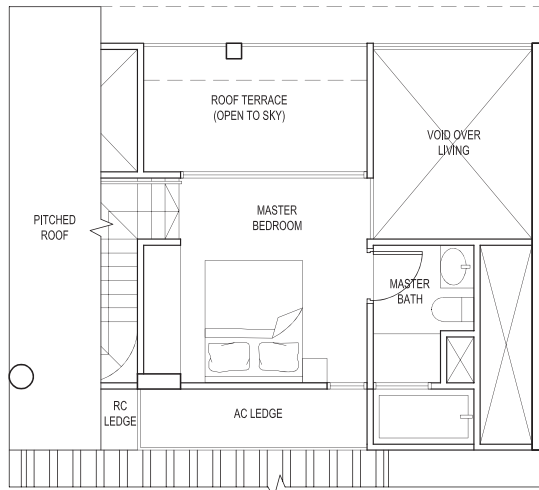

UPPER FLOOR

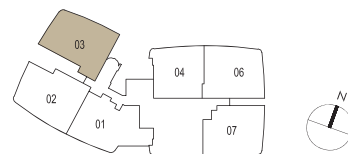

3-Bedroom Penthouse

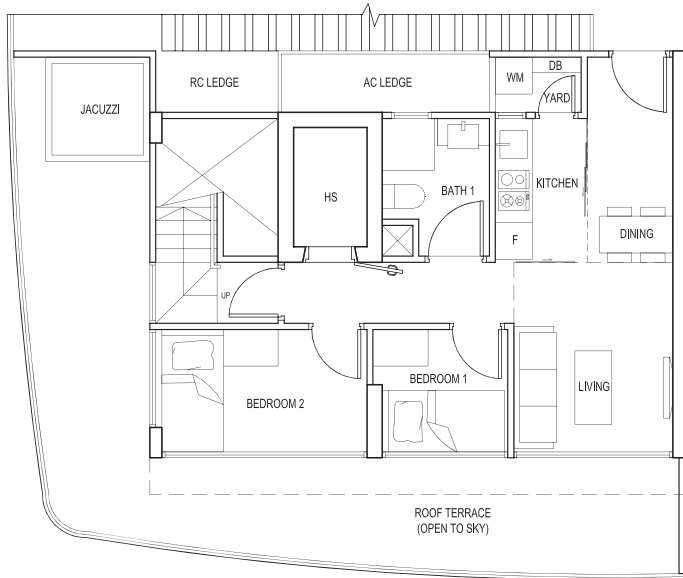

Type P6

#36-02

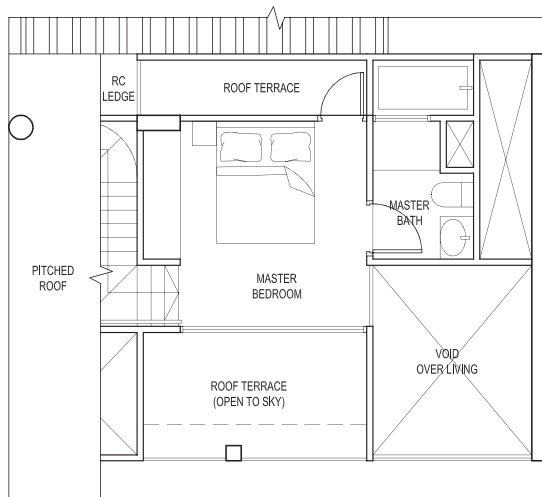

UPPER FLOOR

