

TYPE A1

65 sq m / 700 sq ft

#02-02

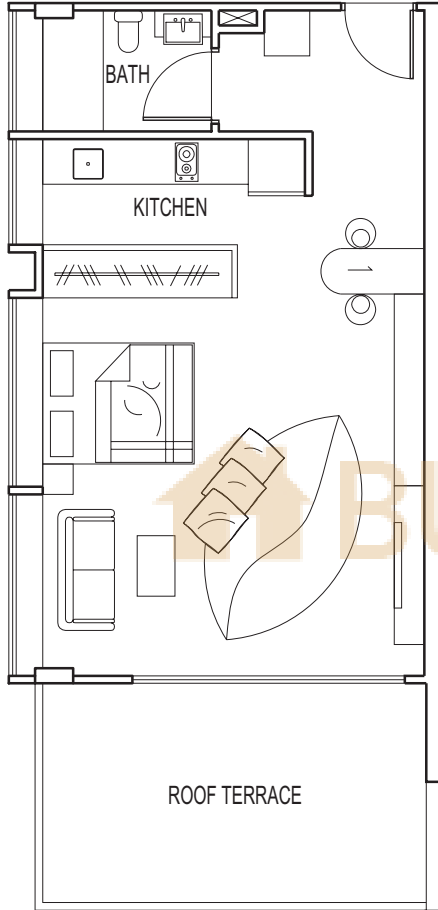

TYPE A

55 sq m / 592 sq ft

#03-02

#04-02

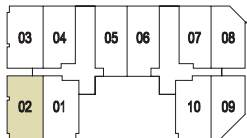
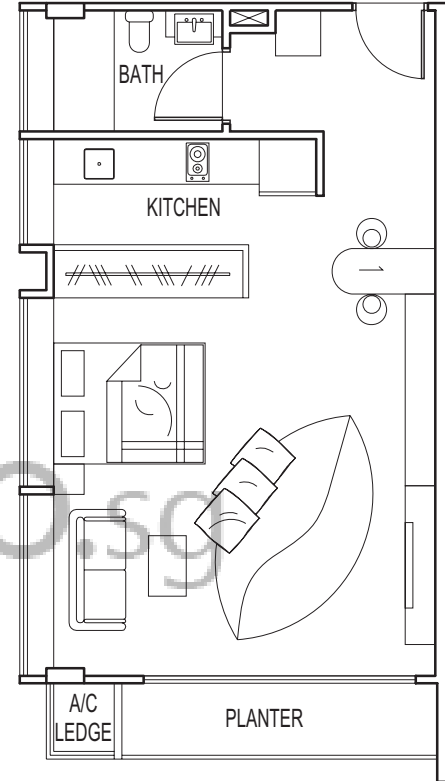

NOT TO SCALE

• Plans are subject to change as may be approved by the relevant authority. Areas are approximate measurements and subject to final survey. Plans are not to scale

TYPE B1

82 sq m / 883 sq ft

#02-01
#02-10

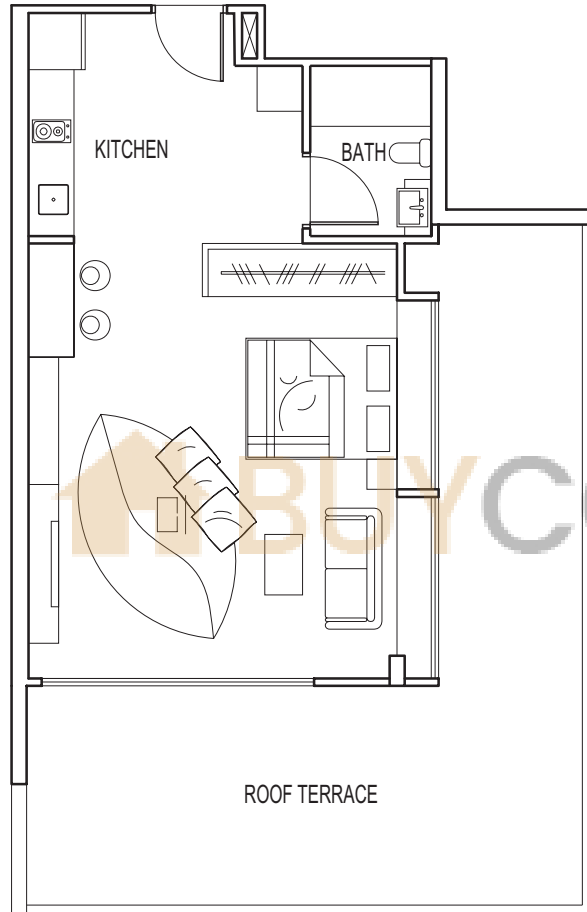

TYPE B

52 sq m / 560 sq ft

#03-01
#04-01
#03-10
#04-10

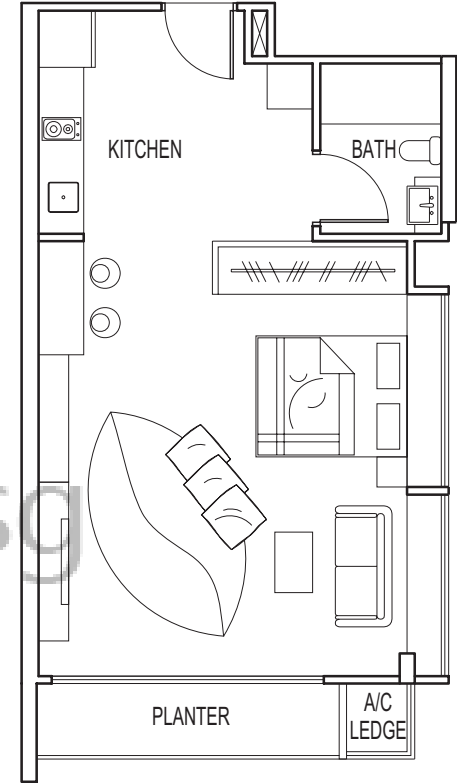

• Plans are subject to change as may be approved by the relevant authority. Areas are approximate measurements and subject to final survey. Plans are not to scale

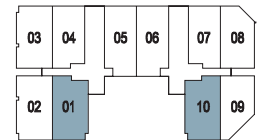

TYPE C / CI (High Ceiling)

53 sq m / 570 sq ft

- #02-03
- #03-03
- #04-03
- #05-03
- #06-03 (CI)

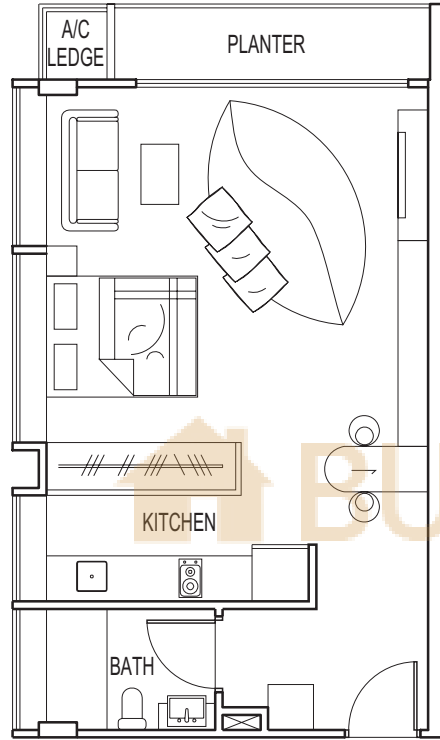

TYPE D / DI (High Ceiling)

55 sq m / 592 sq ft

- #02-04
- #03-04
- #04-04
- #05-04
- #06-04 (DI)
- #02-07
- #03-07
- #04-07
- #05-07
- #06-07 (DI)

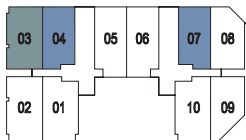
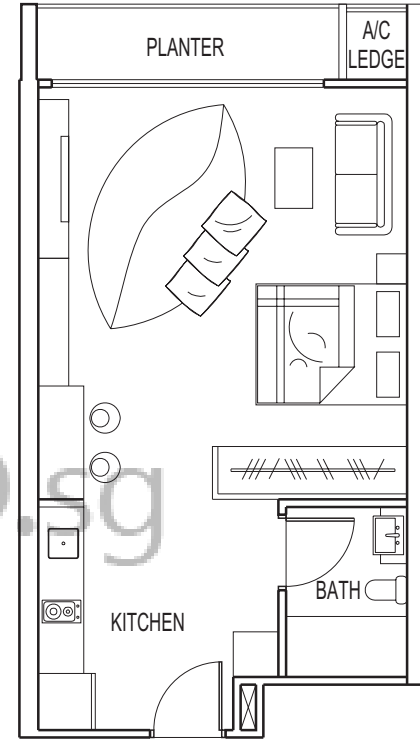

• Plans are subject to change as may be approved by the relevant authority. Areas are approximate measurements and subject to final survey. Plans are not to scale

TYPE E1

56 sq m / 603 sq ft

#02-05
#02-06

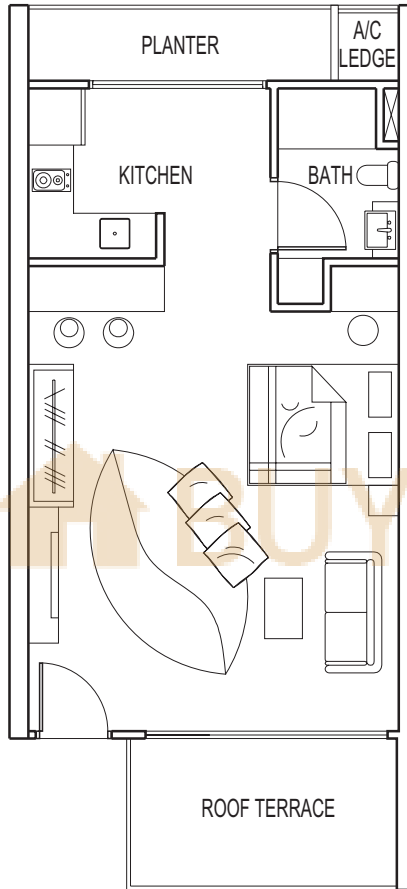

TYPE E / E2 (High Ceiling)

55 sq m / 592 sq ft

#03-05 #03-06
#04-05 #04-06
#05-05 #05-06
#06-05 (E2) #06-06 (E2)

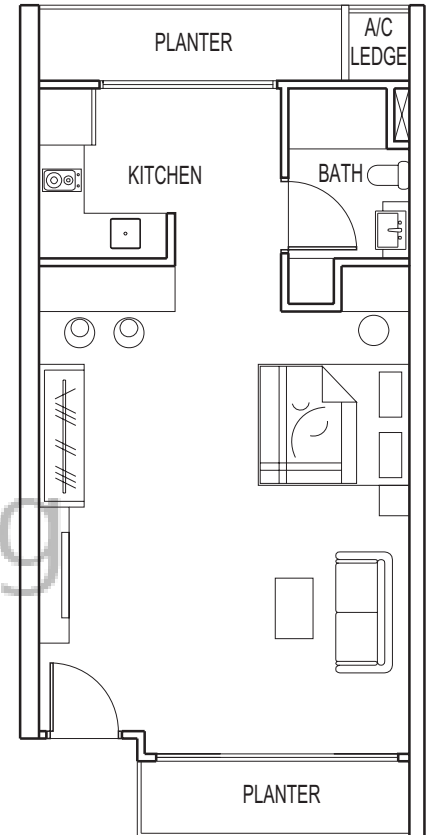

BUY CONDO.sg

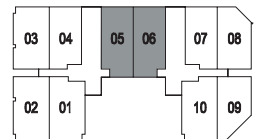

• Plans are subject to change as may be approved by the relevant authority. Areas are approximate measurements and subject to final survey. Plans are not to scale



TYPE F / F1 (High Ceiling)

47 sq m / 506 sq ft

- #02-08
- #03-08
- #04-08
- #05-08
- #06-08 (F1)

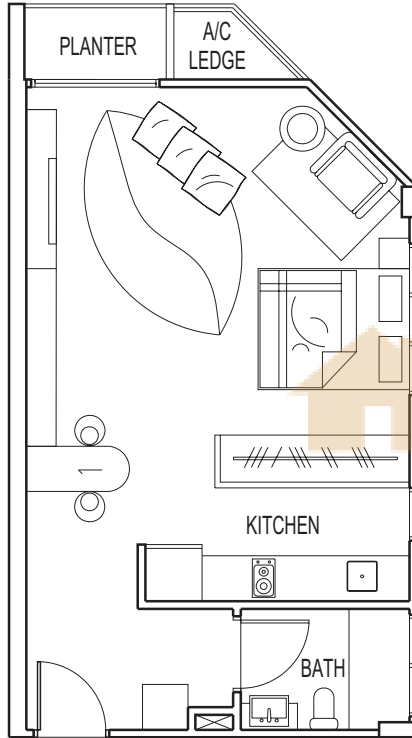

TYPE G1

45 sq m / 484 sq ft

- #02-09

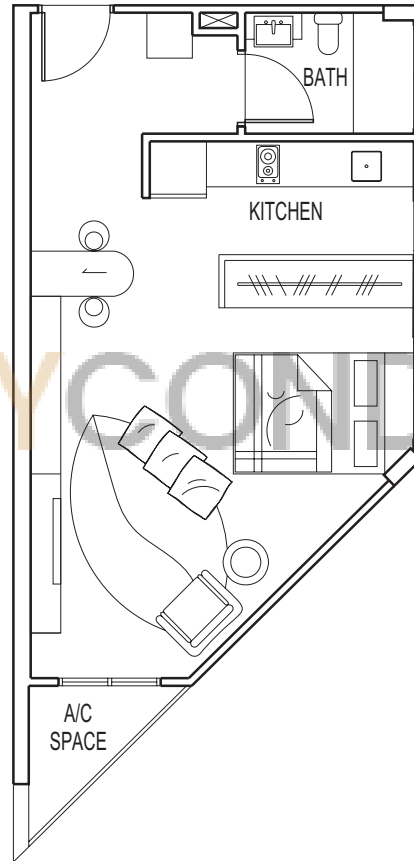

TYPE G

44 sq m / 473 sq ft

- #03-09
- #04-09

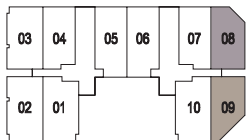
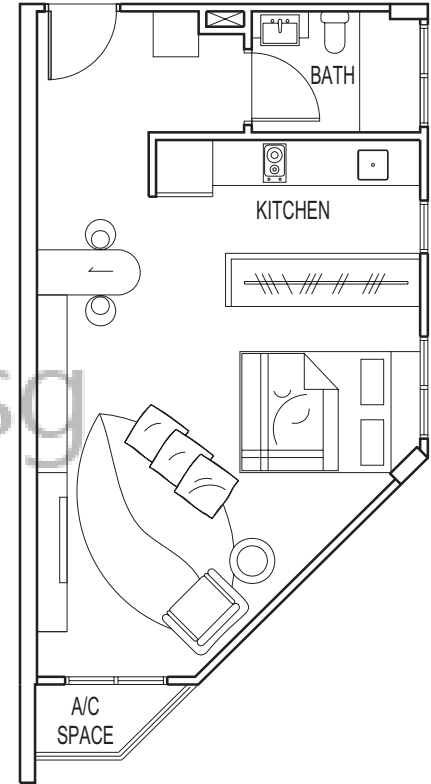

NOT TO SCALE

• Plans are subject to change as may be approved by the relevant authority. Areas are approximate measurements and subject to final survey. Plans are not to scale

TYPE H

102 sq m / 1098 sq ft

#05-02

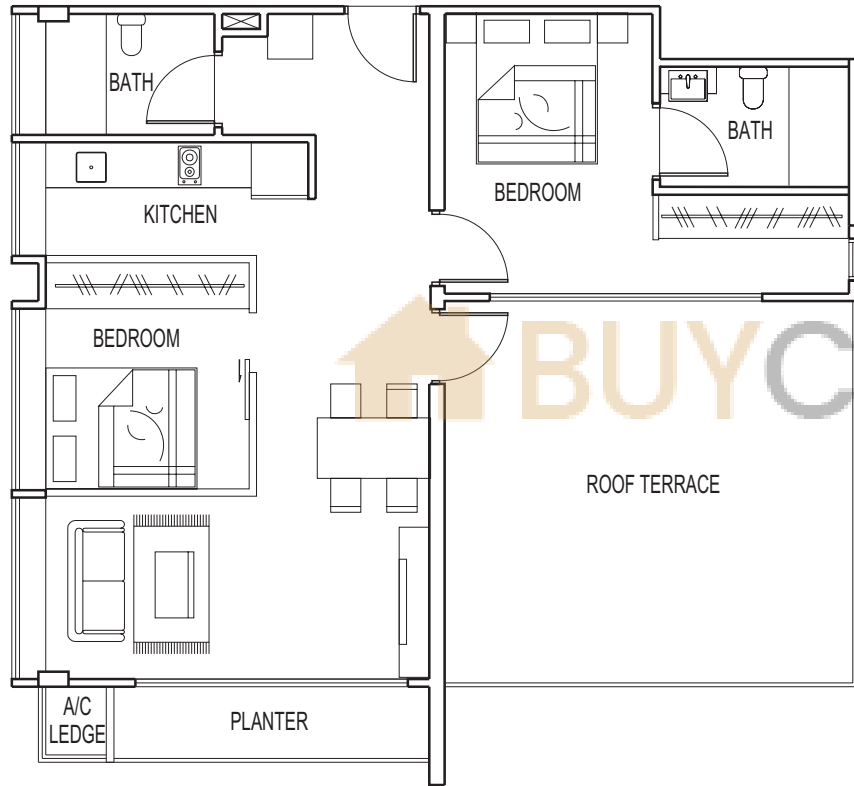

TYPE I

91 sq m / 980 sq ft

#05-09

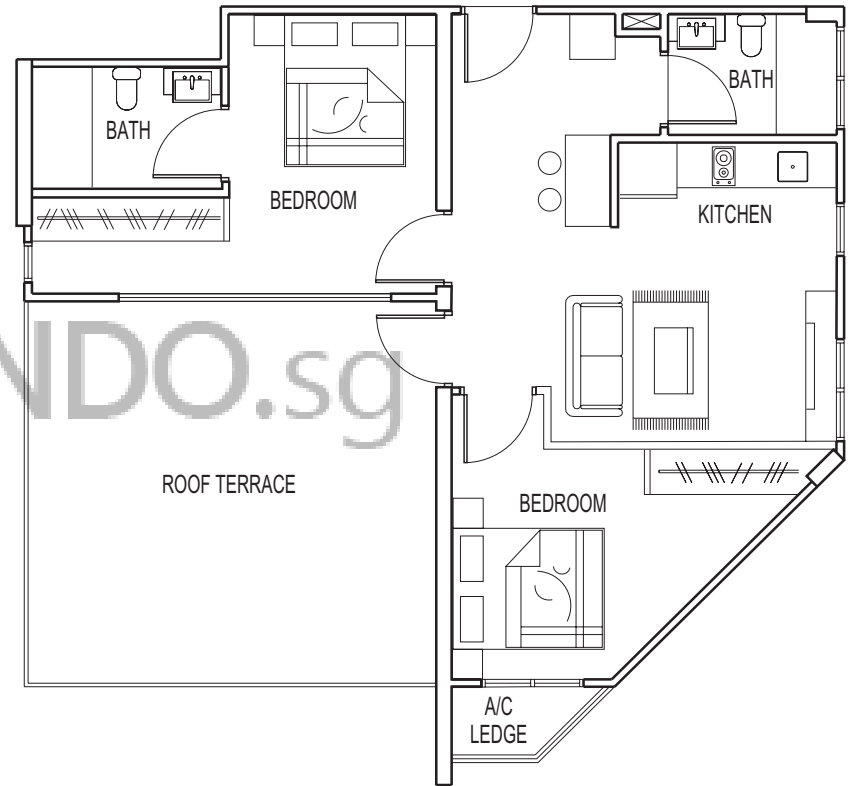

• Plans are subject to change as may be approved by the relevant authority. Areas are approximate measurements and subject to final survey. Plans are not to scale



TYPE J (High Ceiling)

74 sq m /800 sq ft

#06-02

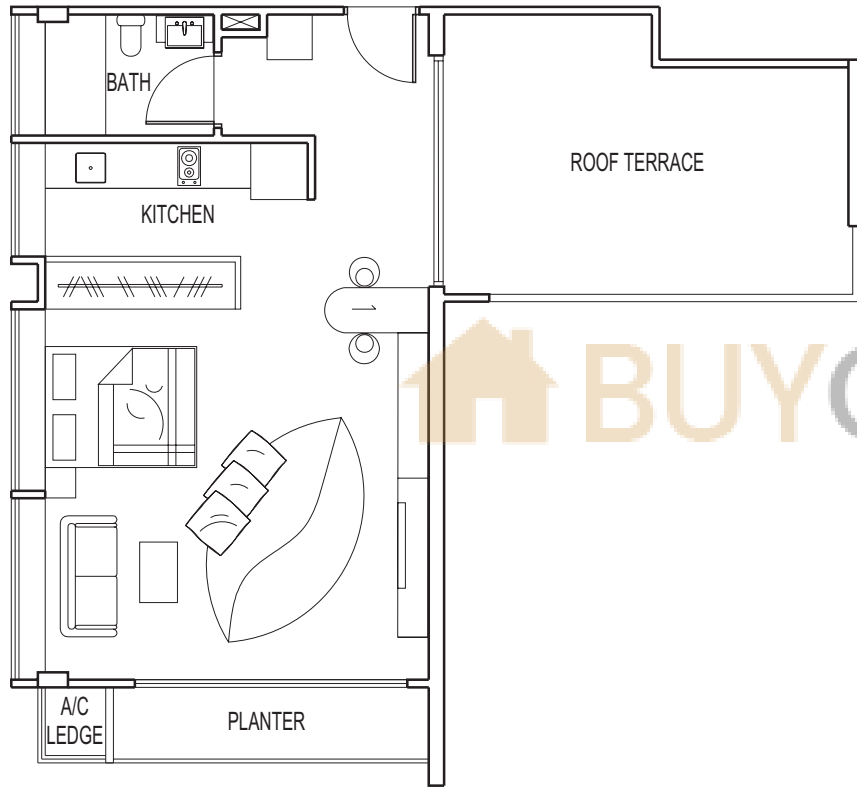

TYPE K (High Ceiling)

63 sq m /678 sq ft

#06-09

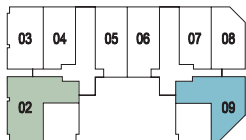
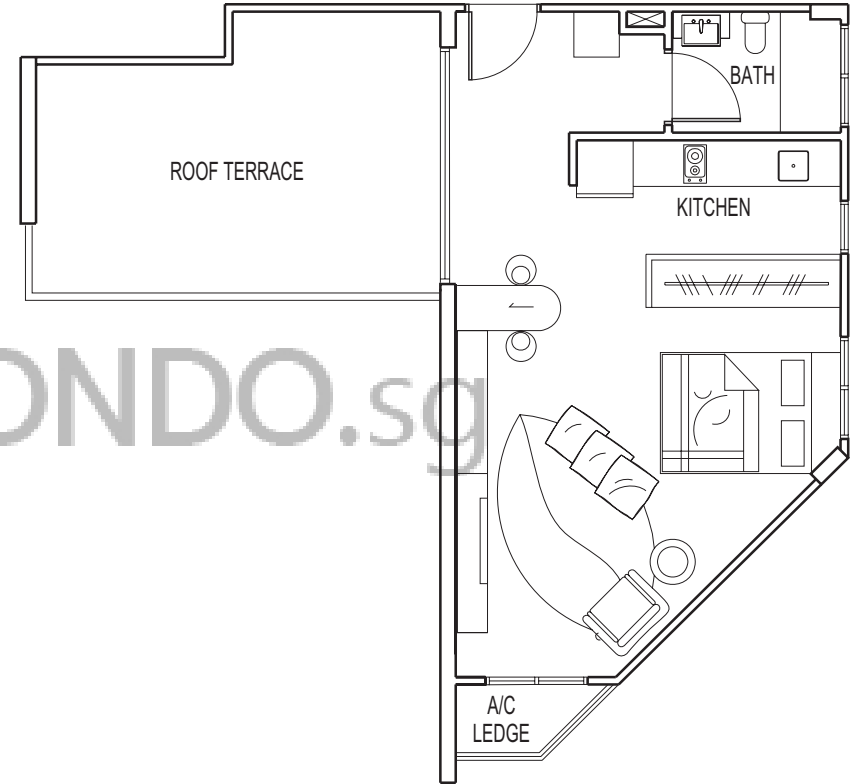

• Plans are subject to change as may be approved by the relevant authority. Areas are approximate measurements and subject to final survey. Plans are not to scale