

basement

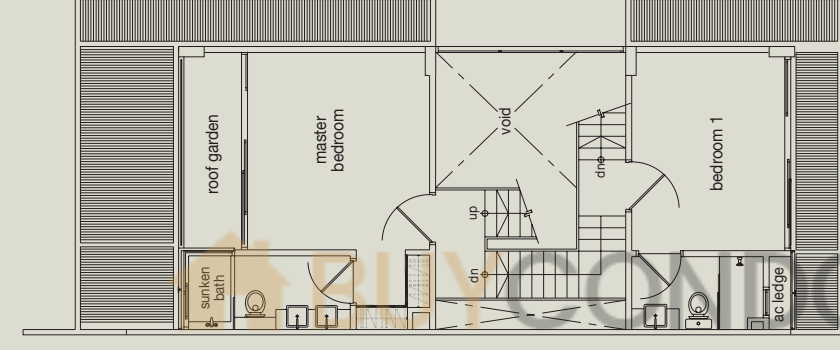

1st storey

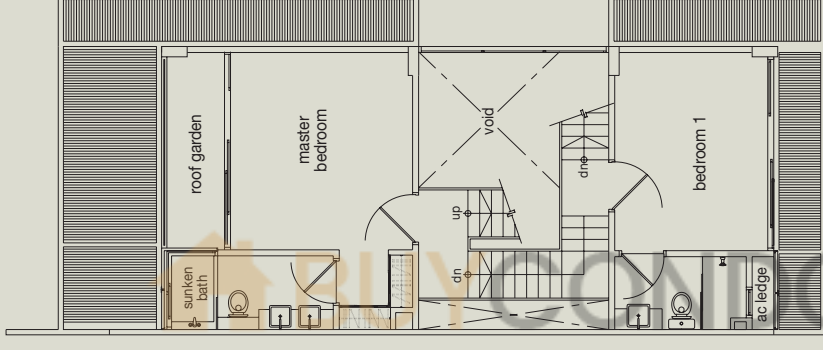

2nd storey

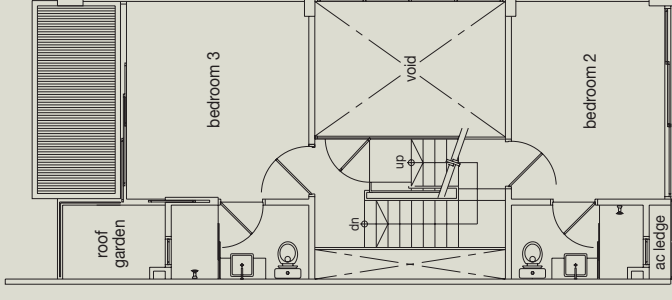

3rd storey

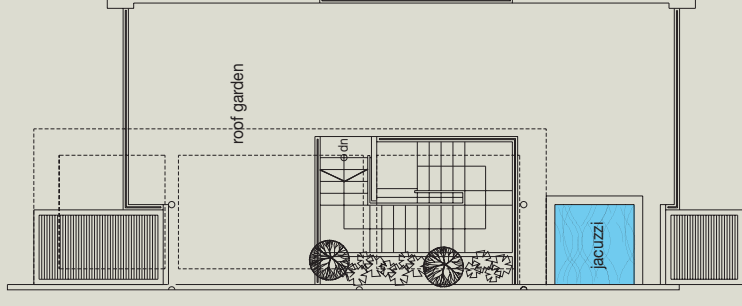

attic

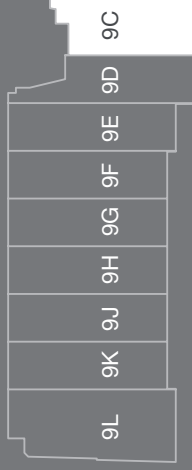

9L 9K 9J 9H 9G 9F 9E 9D 9C

No. 9C ■ 462 sq m ■ 4 + 1 + 1

Inclusive of all build up areas and void.



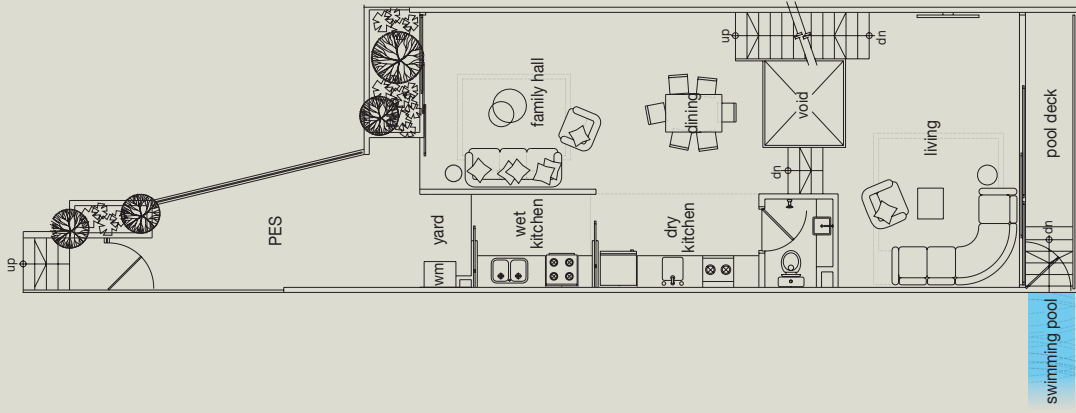

1st storey

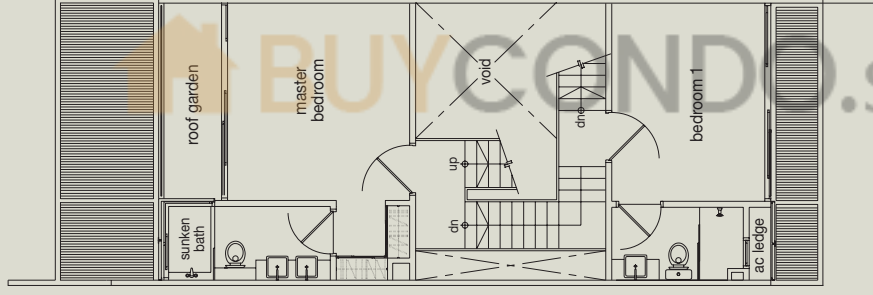

2nd storey

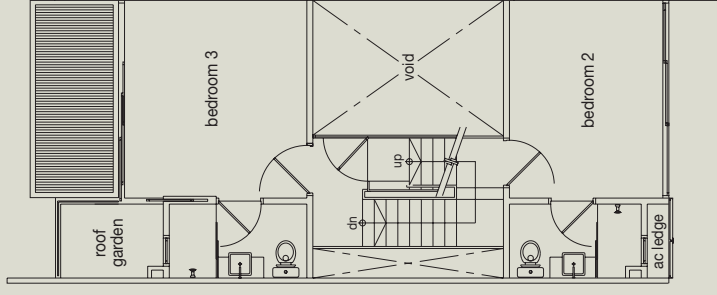

3rd storey

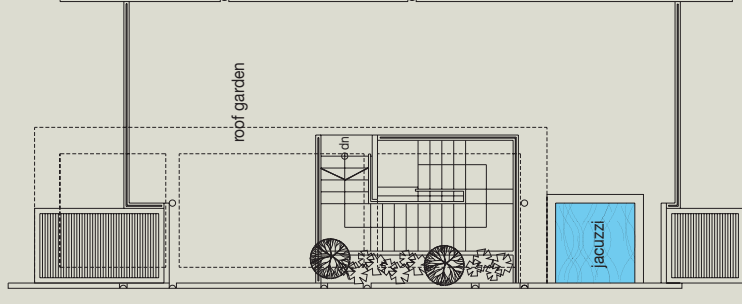

attic

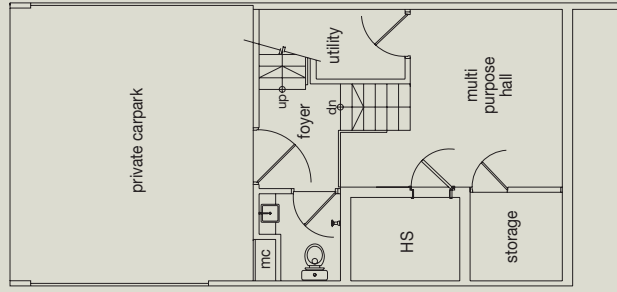

basement

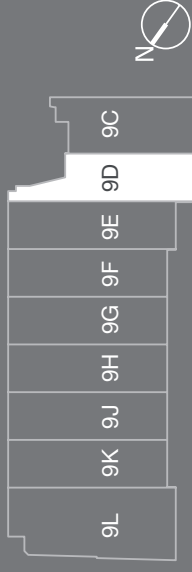

**No. 9D** ■ 392 sq m ■ 4 + 1 + 1

Inclusive of all build up areas and void.

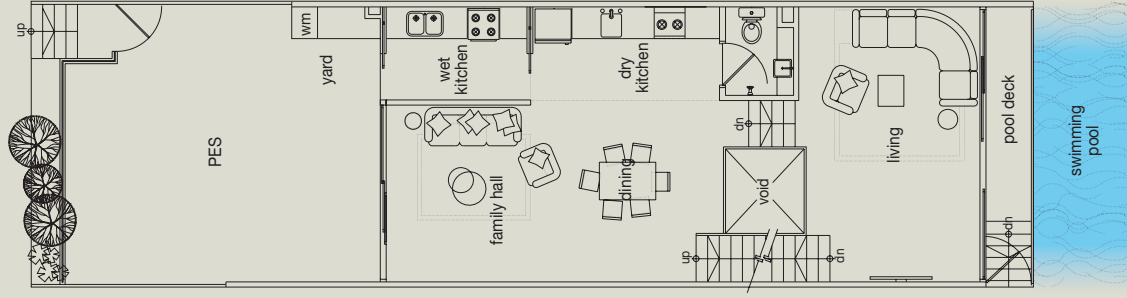

1st storey

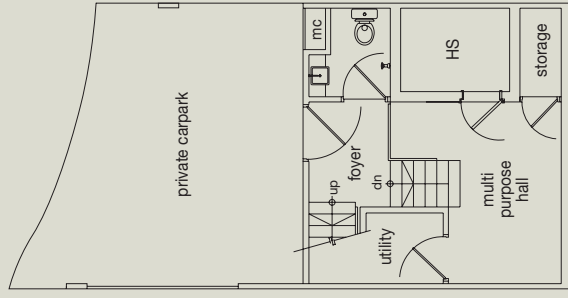

basement

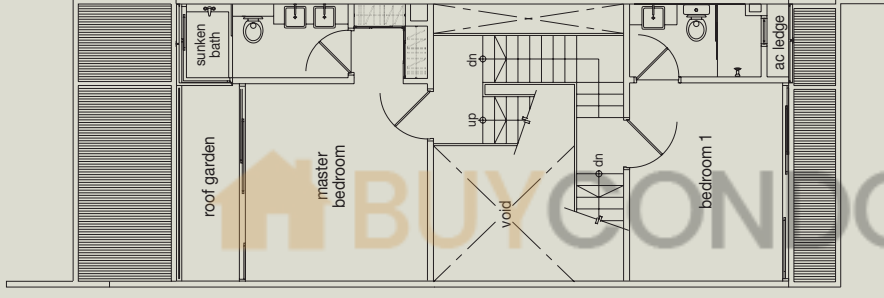

2nd storey

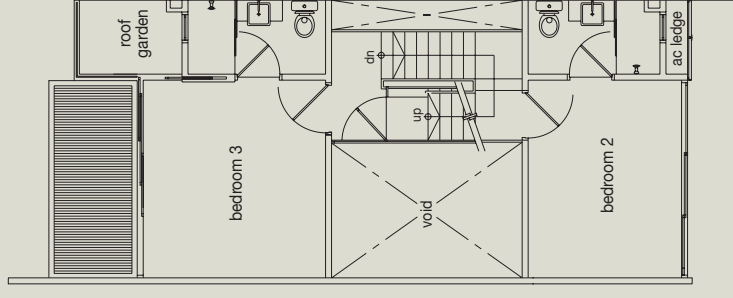

3rd storey

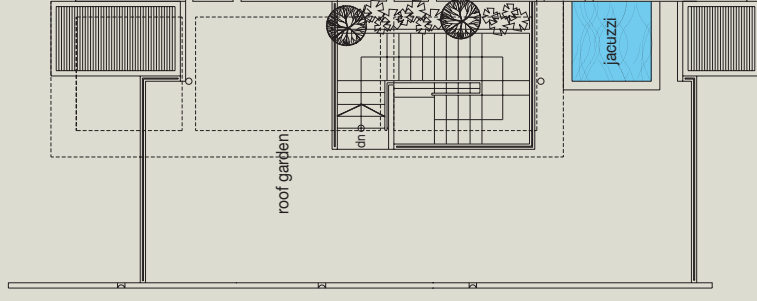

attic



**No. 9E** ■ 410 sq m ■ 4 + 1 + 1  
 Inclusive of all build up areas and void.

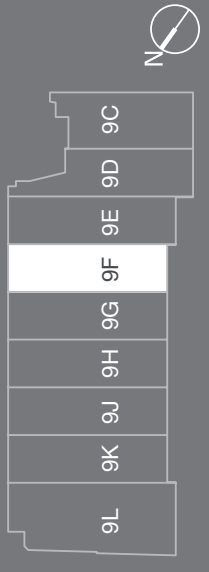
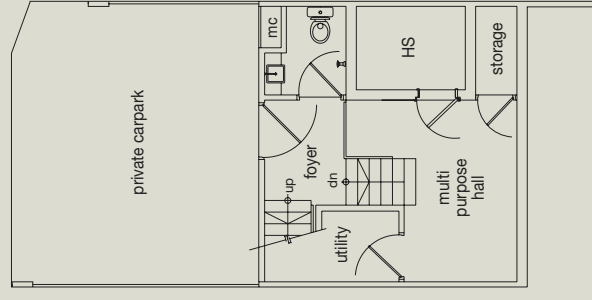
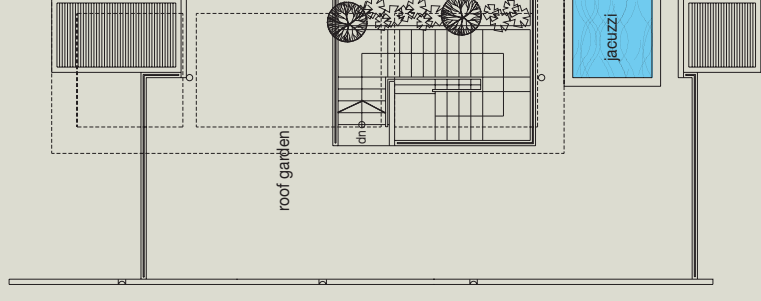
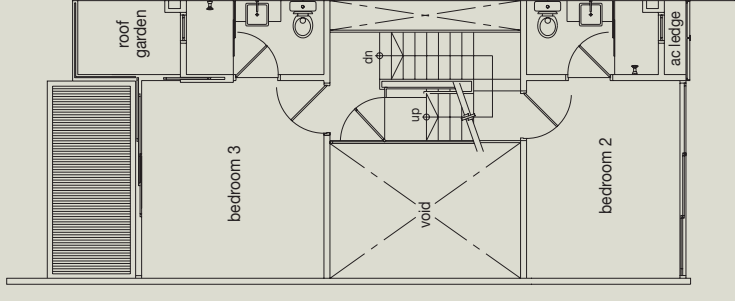
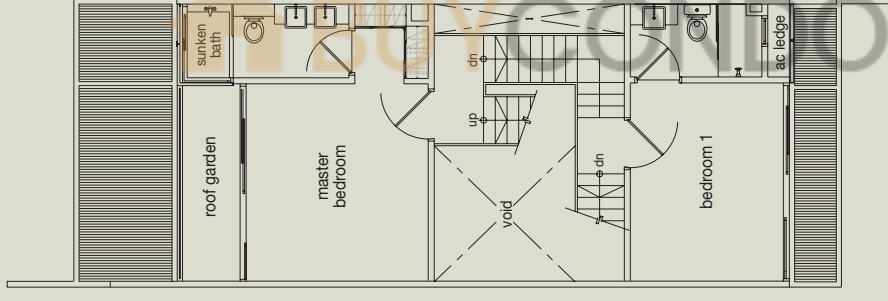
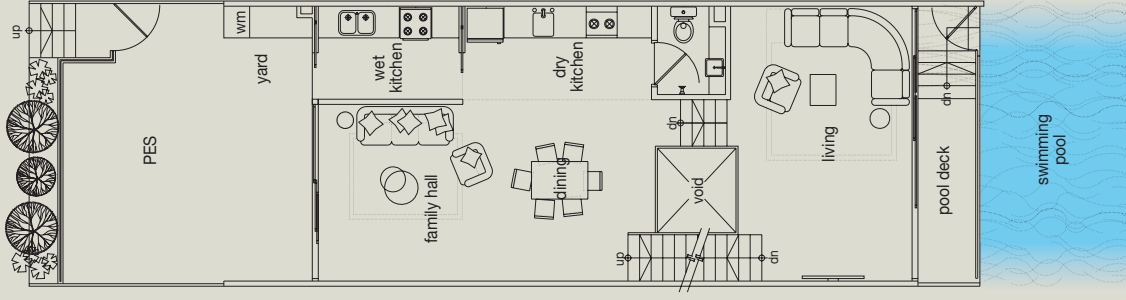

**No. 9F** ■ 404 sq m ■ 4 + 1 + 1  
 Inclusive of all build up areas and void.



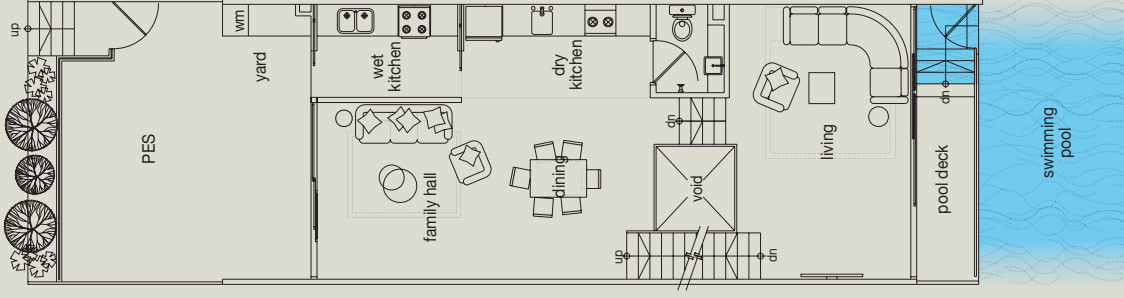

1st storey

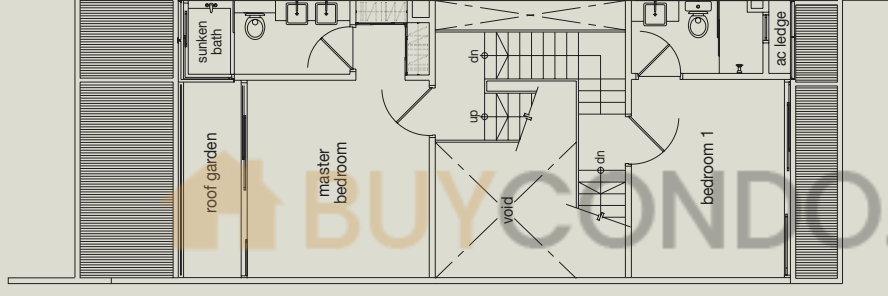

2nd storey

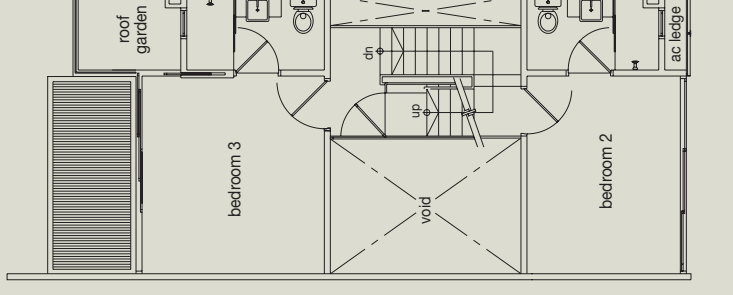

3rd storey

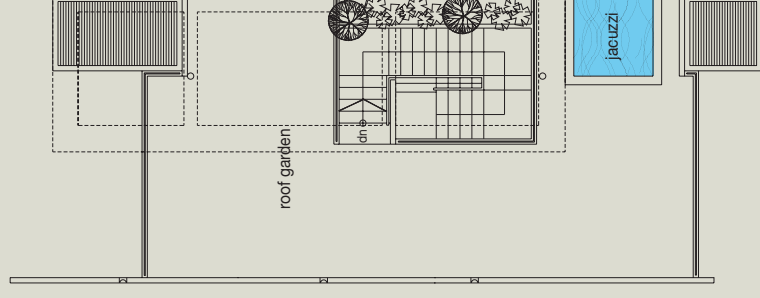

attic

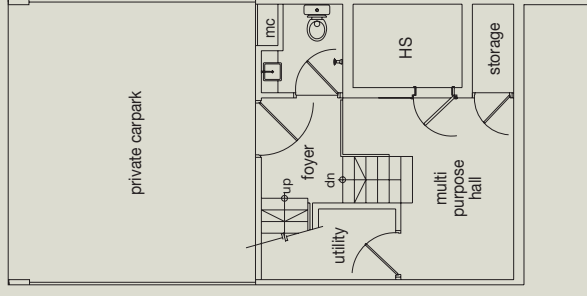

basement



**No. 9G ■ 9H ■ 9J ■ 9K ■ 9L** ■ 404 sq m ■ 4 + 1 + 1

Inclusive of all build up areas and void.

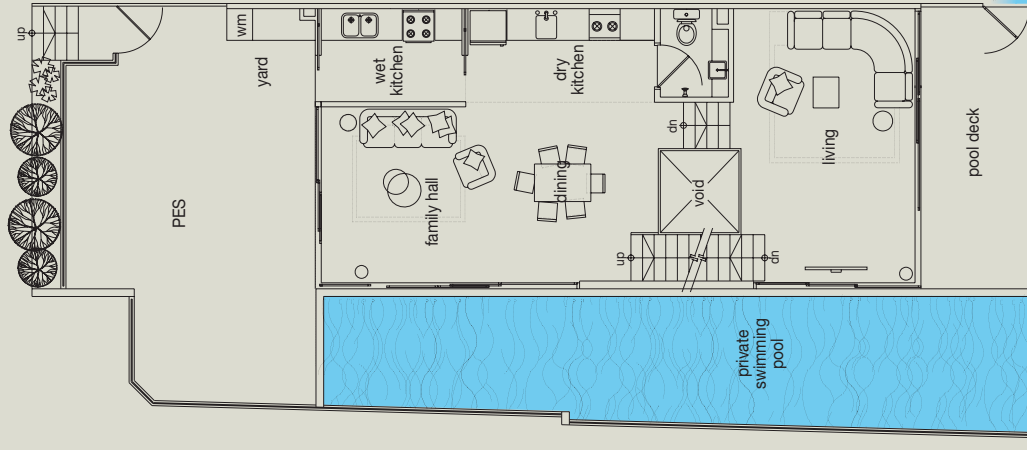

1st storey

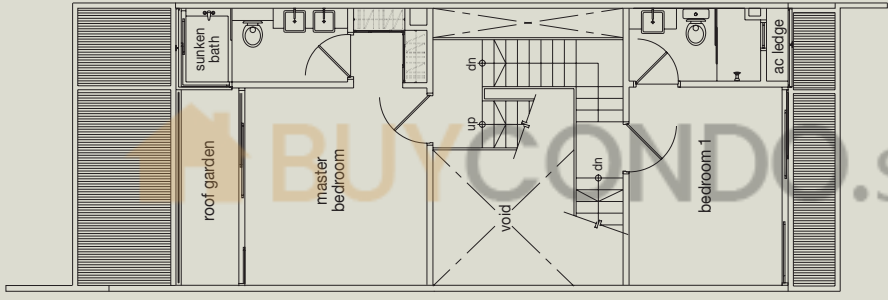

2nd storey

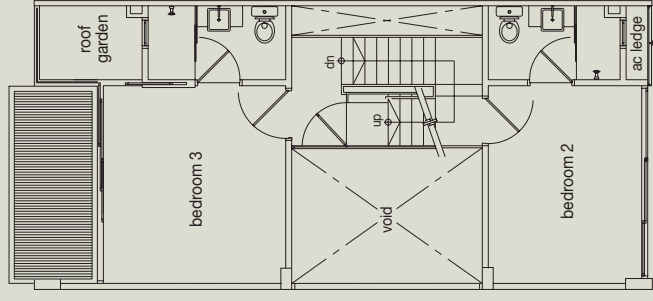

3rd storey

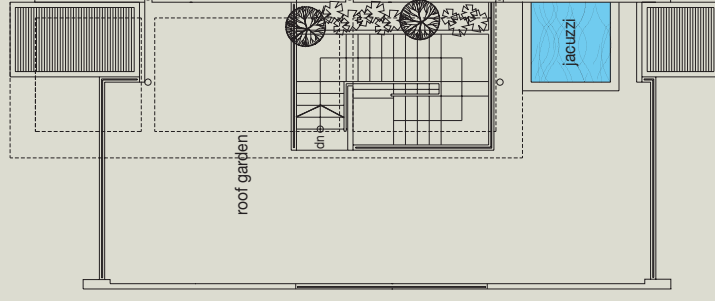

attic

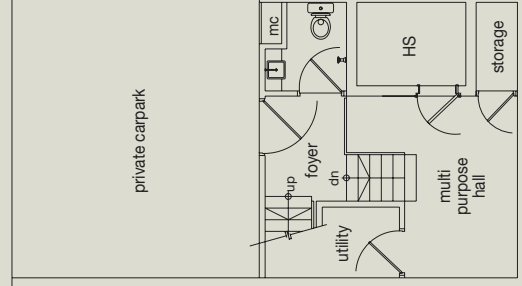

basement

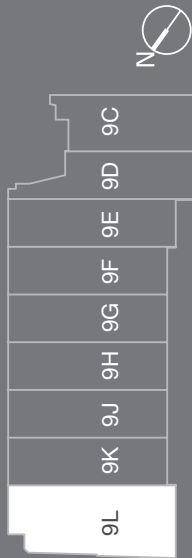

**No. 9L** ■ 500 sq m ■ 4 + 1 + 1  
 Inclusive of all build up areas and void.