

1 Bedroom

TYPE A1

46 sqm / 495 sqft

(114C) #02-11 to #10-11, #13-11 to #20-11





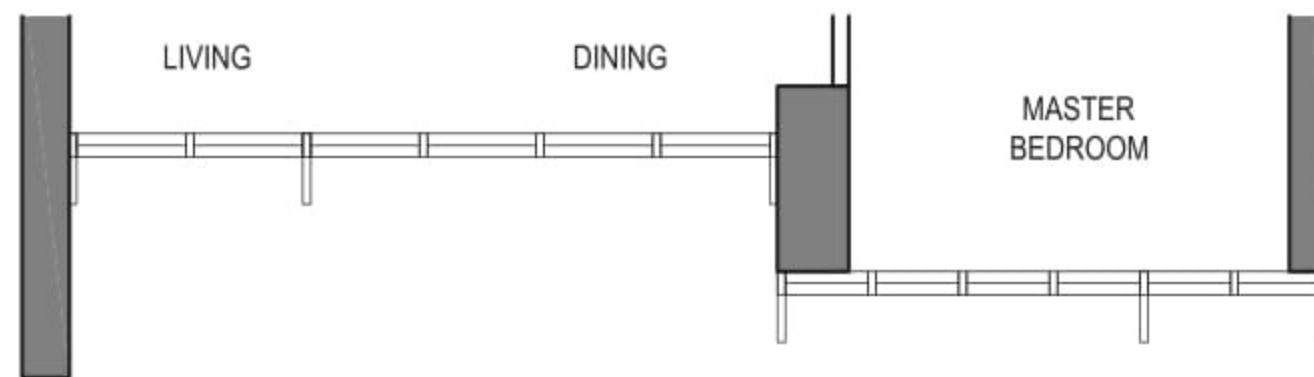



(114C) #02-11, #05-11 to #07-11, #13-11 to #19-11



(114C) #03-11 to #04-11, #08-11 to #10-11, #20-11

LEGEND:

 WASHER CUM DRYER	 FRIDGE	 OVEN (BELOW HOB)
 DISTRIBUTION BOX	 VOID SPACE (EXCLUDED FROM THE STRATA AREA)	 AC LEDGE

NOTE:
 AREA INCLUDES A/C LEDGE AND BALCONY WHERE APPLICABLE. THE ABOVE PLANS AND ILLUSTRATIONS ARE SUBJECT TO CHANGE AS MAYBE REQUIRED OR APPROVED BY THE RELEVANT AUTHORITIES. ALL FLOOR AREAS ARE APPROXIMATE ONLY AND SUBJECT TO FINAL SURVEY. PLEASE REFER TO KEY PLAN FOR ORIENTATION. FOR AN ILLUSTRATION OF THE APPROVED BALCONY SCREEN, PLEASE REFER TO "BALCONY SCREEN" PAGE IN THIS BROCHURE.

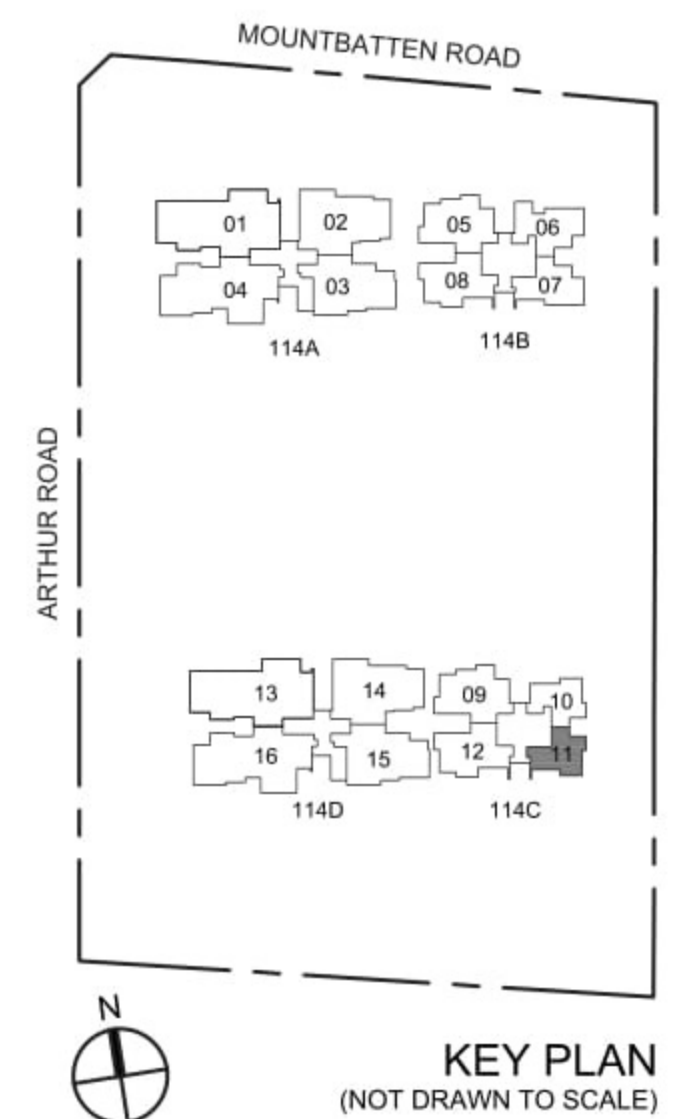

1 Bedroom





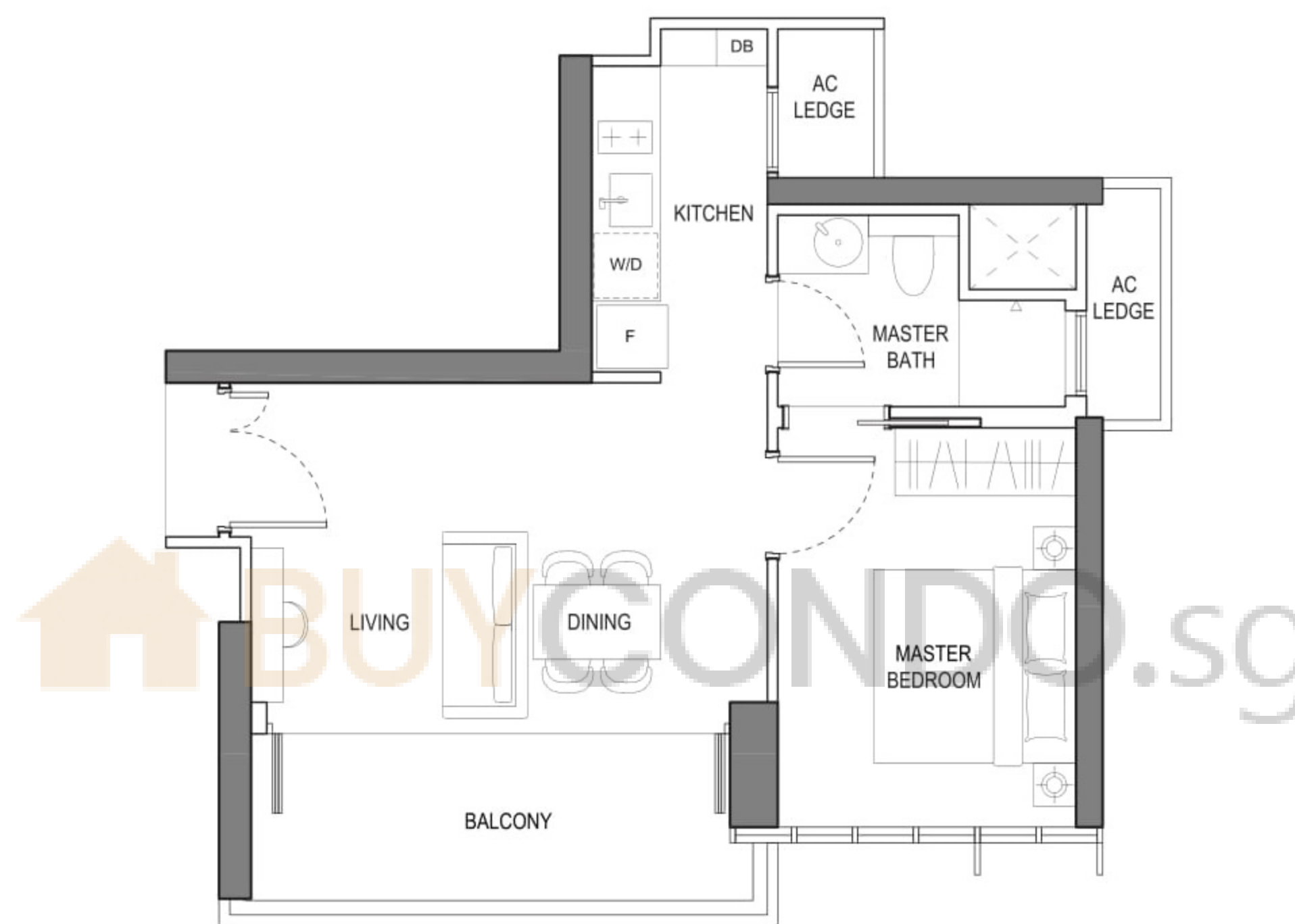

TYPE A1(a)

54 sqm / 581 sqft

(114C) #11-11 to #12-11



LEGEND:

 W/D	WASHER CUM DRYER	 F	FRIDGE	 O	OVEN (BELOW HOB)
 DB	DISTRIBUTION BOX		VOID SPACE (EXCLUDED FROM THE STRATA AREA)		AC LEDGE

NOTE:
 AREA INCLUDES A/C LEDGE AND BALCONY WHERE APPLICABLE. THE ABOVE PLANS AND ILLUSTRATIONS ARE SUBJECT TO CHANGE AS MAYBE REQUIRED OR APPROVED BY THE RELEVANT AUTHORITIES. ALL FLOOR AREAS ARE APPROXIMATE ONLY AND SUBJECT TO FINAL SURVEY. PLEASE REFER TO KEY PLAN FOR ORIENTATION. FOR AN ILLUSTRATION OF THE APPROVED BALCONY SCREEN, PLEASE REFER TO "BALCONY SCREEN" PAGE IN THIS BROCHURE.

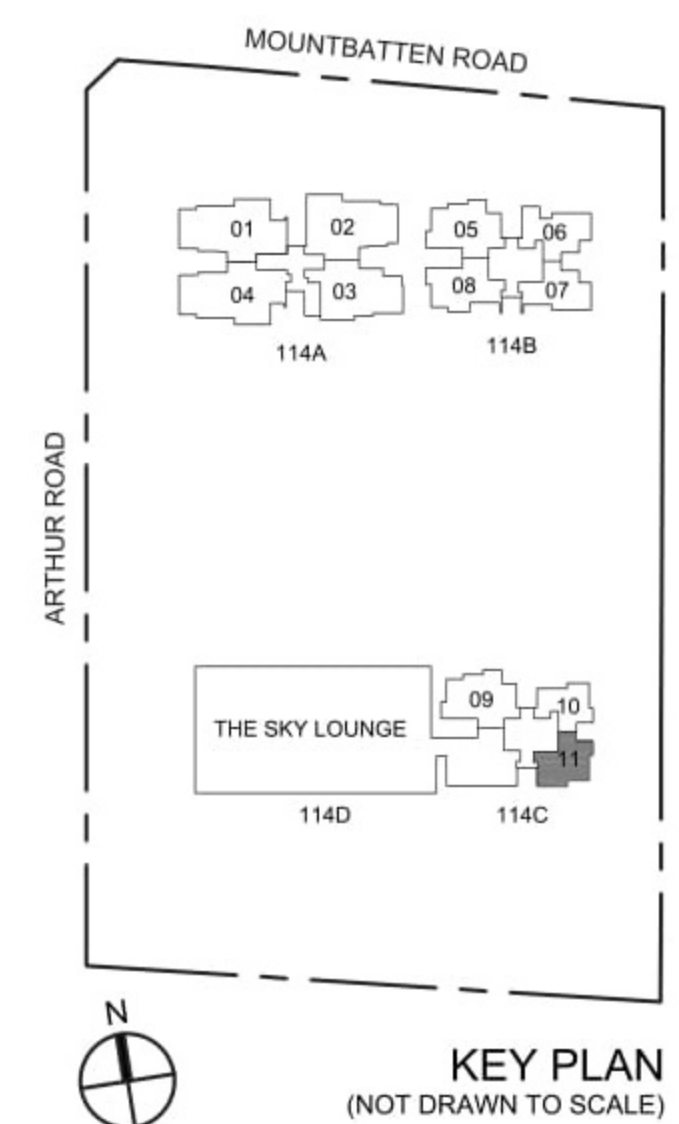

KEY PLAN
(NOT DRAWN TO SCALE)

1 Bedroom

TYPE A2(p)

62 sqm / 667 sqft

(114C) #01-10

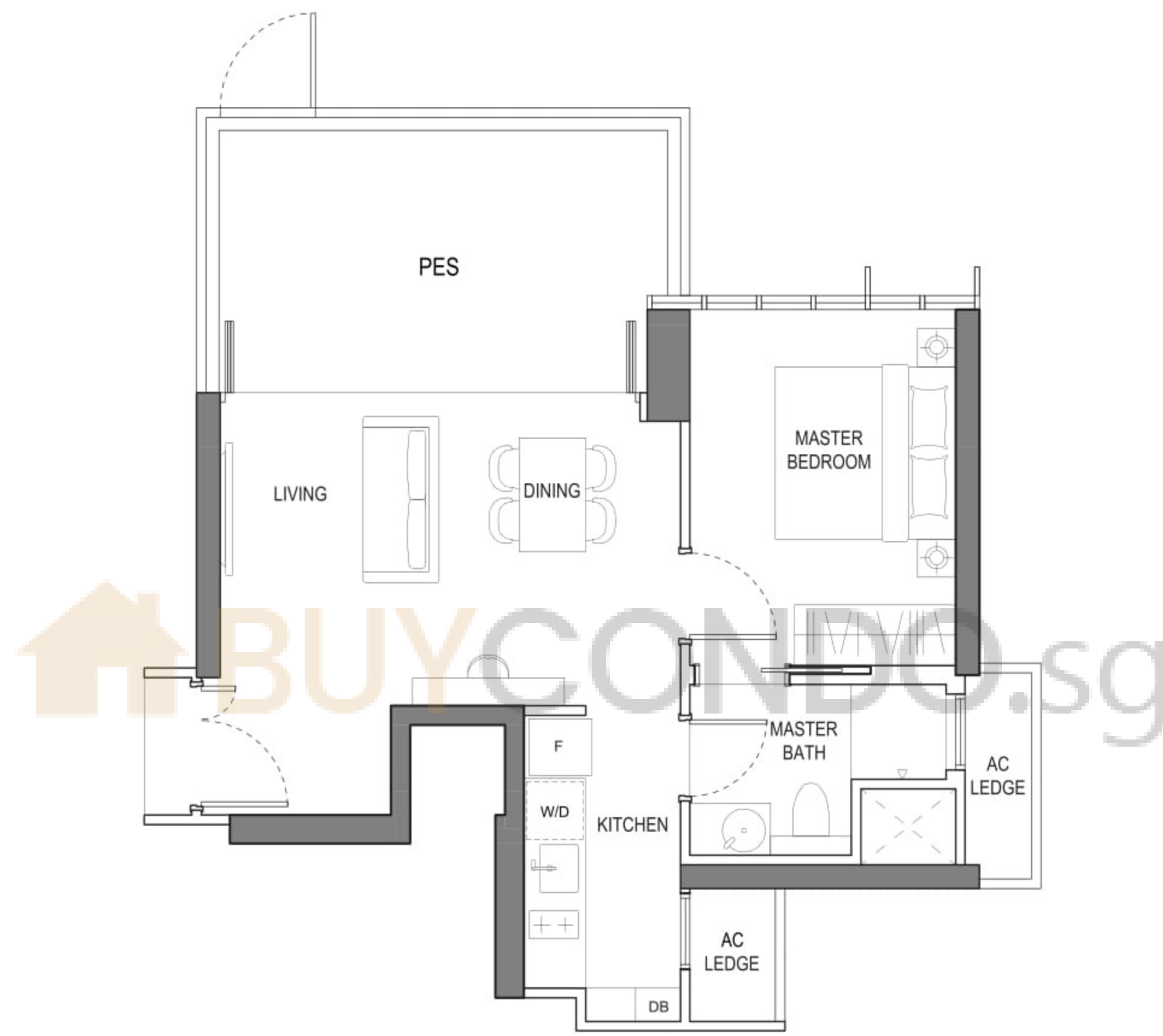

LEGEND:

- | | | | | | |
|-----|------------------|---|--|---|------------------|
| W/D | WASHER CUM DRYER | F | FRIDGE | O | OVEN (BELOW HOB) |
| DB | DISTRIBUTION BOX | | VOID SPACE (EXCLUDED FROM THE STRATA AREA) | | AC LEDGE |

NOTE:
 AREA INCLUDES A/C LEDGE AND BALCONY WHERE APPLICABLE. THE ABOVE PLANS AND ILLUSTRATIONS ARE SUBJECT TO CHANGE AS MAYBE REQUIRED OR APPROVED BY THE RELEVANT AUTHORITIES. ALL FLOOR AREAS ARE APPROXIMATE ONLY AND SUBJECT TO FINAL SURVEY. PLEASE REFER TO KEY PLAN FOR ORIENTATION. FOR AN ILLUSTRATION OF THE APPROVED BALCONY SCREEN, PLEASE REFER TO "BALCONY SCREEN" PAGE IN THIS BROCHURE.

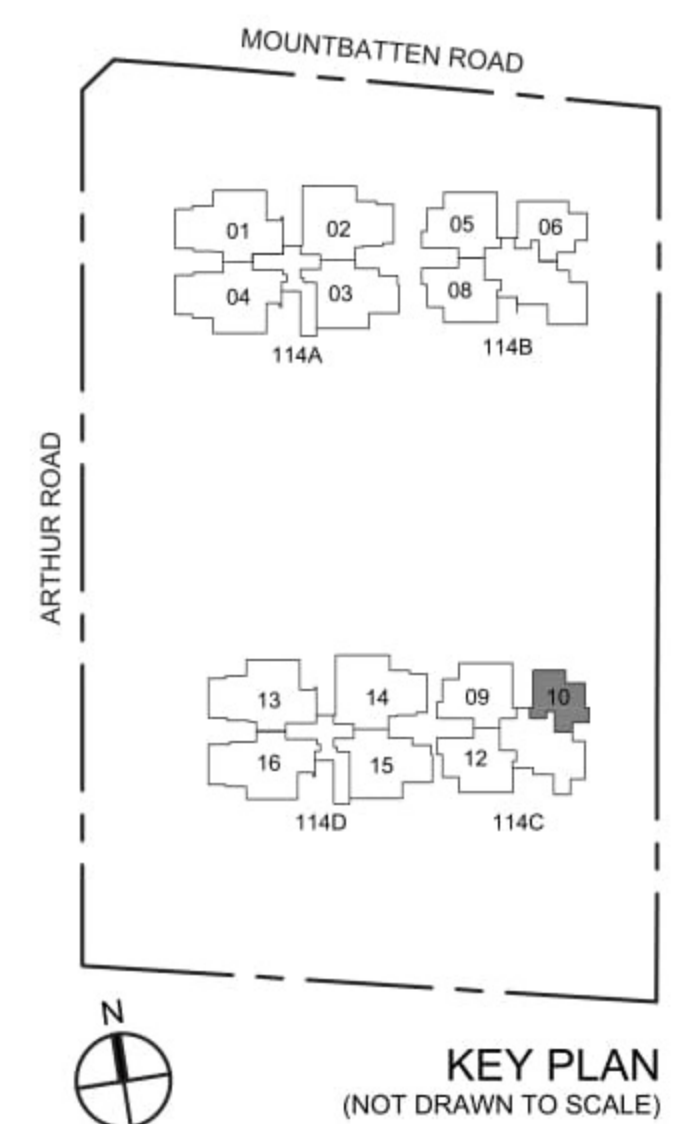

1 Bedroom

TYPE A2

48 sqm / 517 sqft

(114C) #02-10 to #20-10

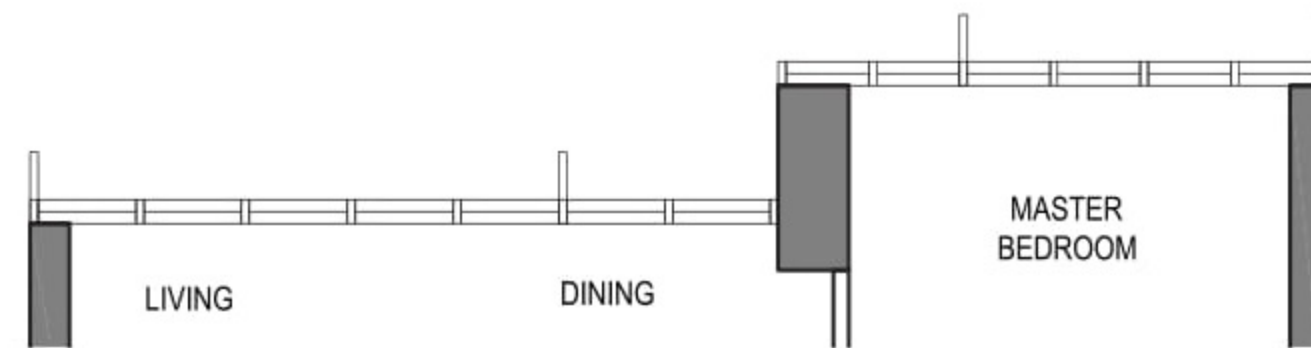



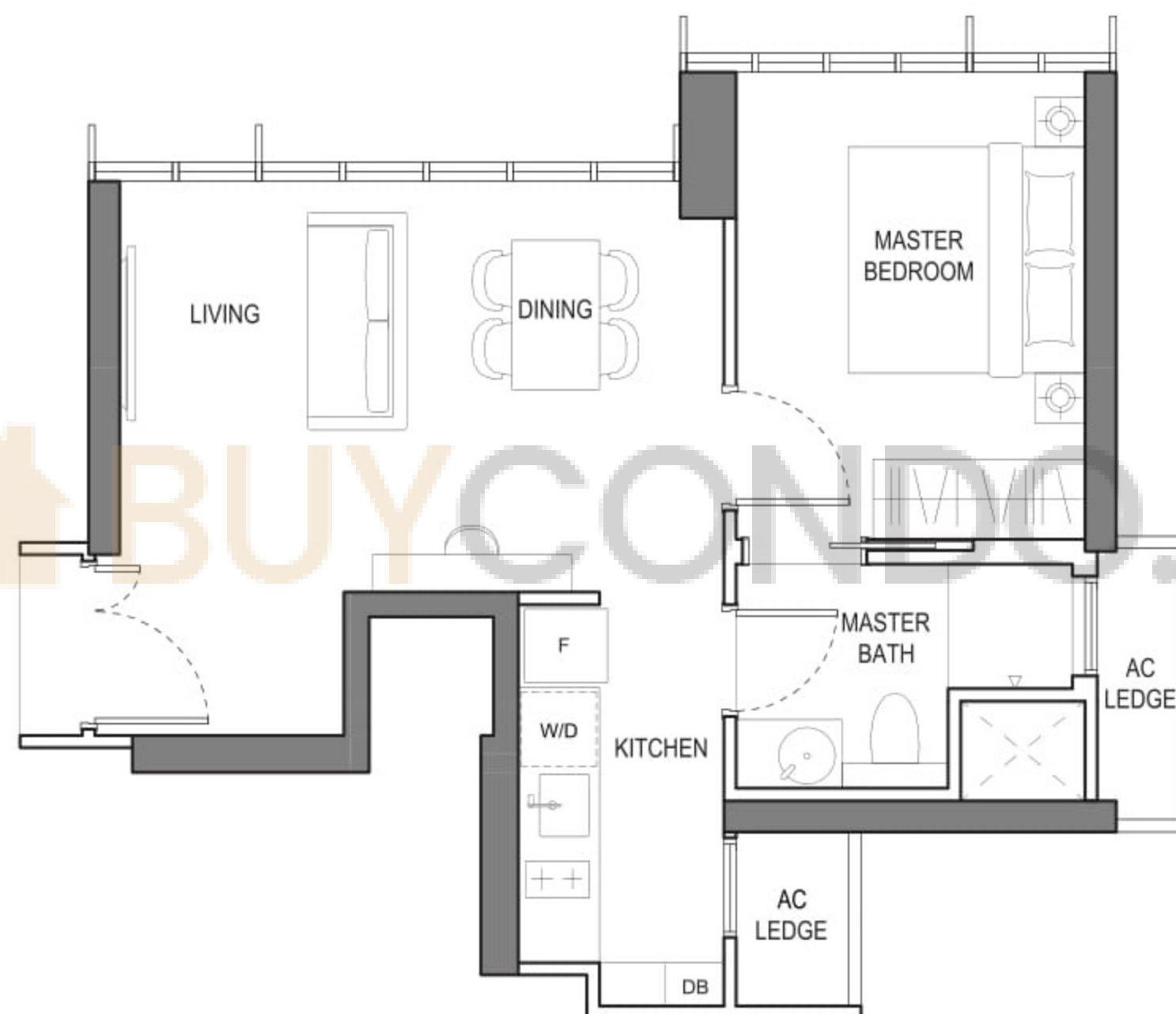



(114C) #03-10 to #04-10, #08-10 to #12-10, #20-10

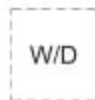

(114C) #02-10, #05-10 to #07-10, #13-10 to #19-10

LEGEND:

 W/D	WASHER CUM DRYER	 F	FRIDGE	 O	OVEN (BELOW HOB)
 DB	DISTRIBUTION BOX		VOID SPACE (EXCLUDED FROM THE STRATA AREA)		AC LEDGE

NOTE:
 AREA INCLUDES A/C LEDGE AND BALCONY WHERE APPLICABLE. THE ABOVE PLANS AND ILLUSTRATIONS ARE SUBJECT TO CHANGE AS MAYBE REQUIRED OR APPROVED BY THE RELEVANT AUTHORITIES. ALL FLOOR AREAS ARE APPROXIMATE ONLY AND SUBJECT TO FINAL SURVEY. PLEASE REFER TO KEY PLAN FOR ORIENTATION. FOR AN ILLUSTRATION OF THE APPROVED BALCONY SCREEN, PLEASE REFER TO "BALCONY SCREEN" PAGE IN THIS BROCHURE.

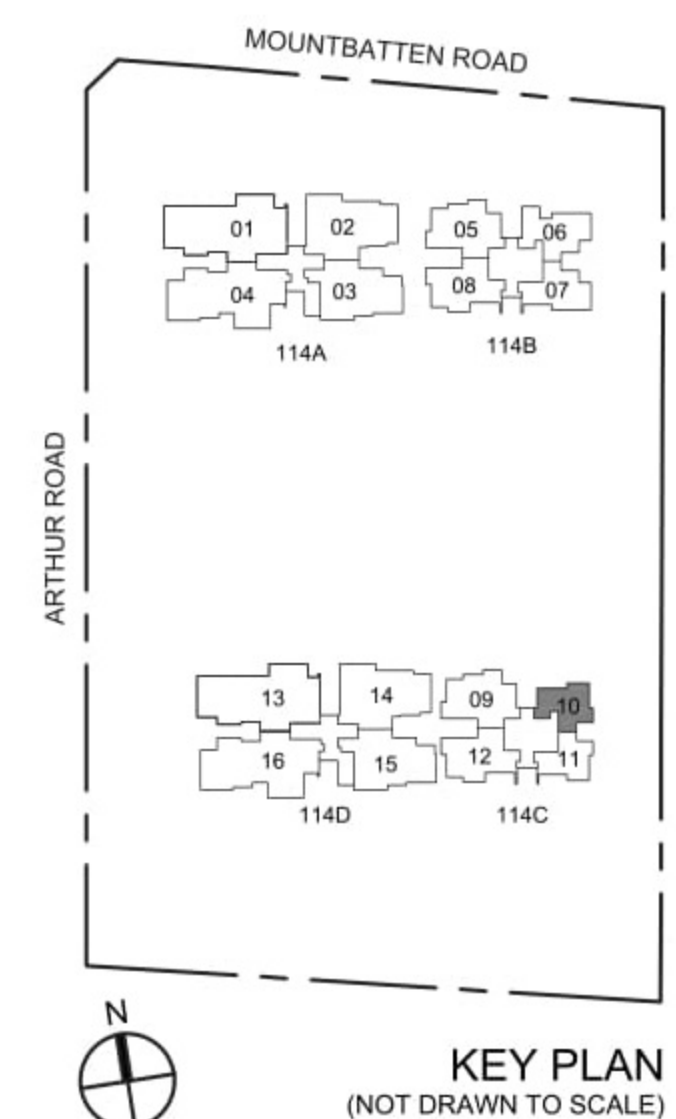

KEY PLAN
(NOT DRAWN TO SCALE)

2 Bedroom

TYPE B1

58 sqm / 624 sqft

(114B) #11-07 to #19-07

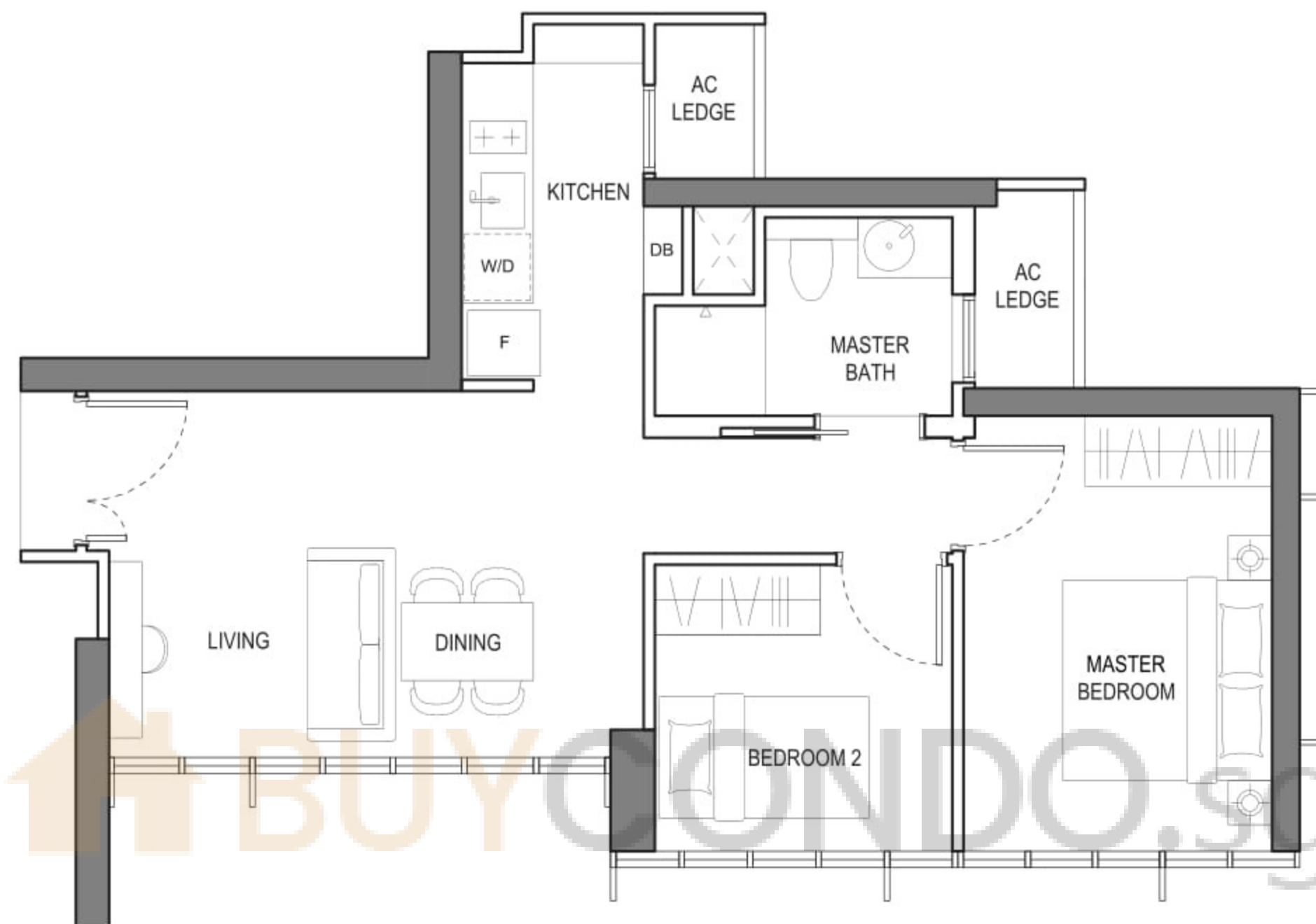

(114B) #11-07 to #13-07

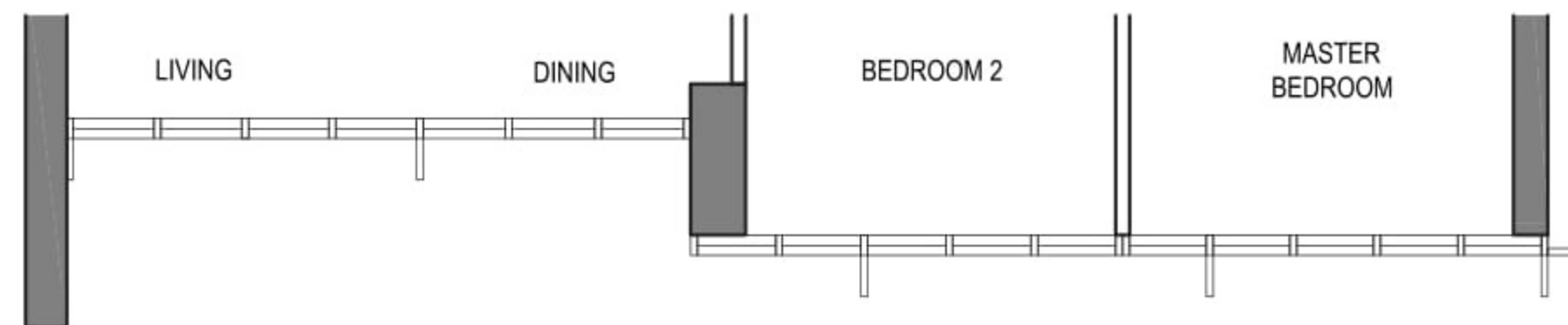

(114B) #14-07 to #19-07

LEGEND:

W/D	WASHER CUM DRYER	F	FRIDGE	O	OVEN (BELOW HOB)
DB	DISTRIBUTION BOX		VOID SPACE (EXCLUDED FROM THE STRATA AREA)	AC LEDGE	AC LEDGE

NOTE:
 AREA INCLUDES A/C LEDGE AND BALCONY WHERE APPLICABLE. THE ABOVE PLANS AND ILLUSTRATIONS ARE SUBJECT TO CHANGE AS MAYBE REQUIRED OR APPROVED BY THE RELEVANT AUTHORITIES. ALL FLOOR AREAS ARE APPROXIMATE ONLY AND SUBJECT TO FINAL SURVEY. PLEASE REFER TO KEY PLAN FOR ORIENTATION. FOR AN ILLUSTRATION OF THE APPROVED BALCONY SCREEN, PLEASE REFER TO "BALCONY SCREEN" PAGE IN THIS BROCHURE.

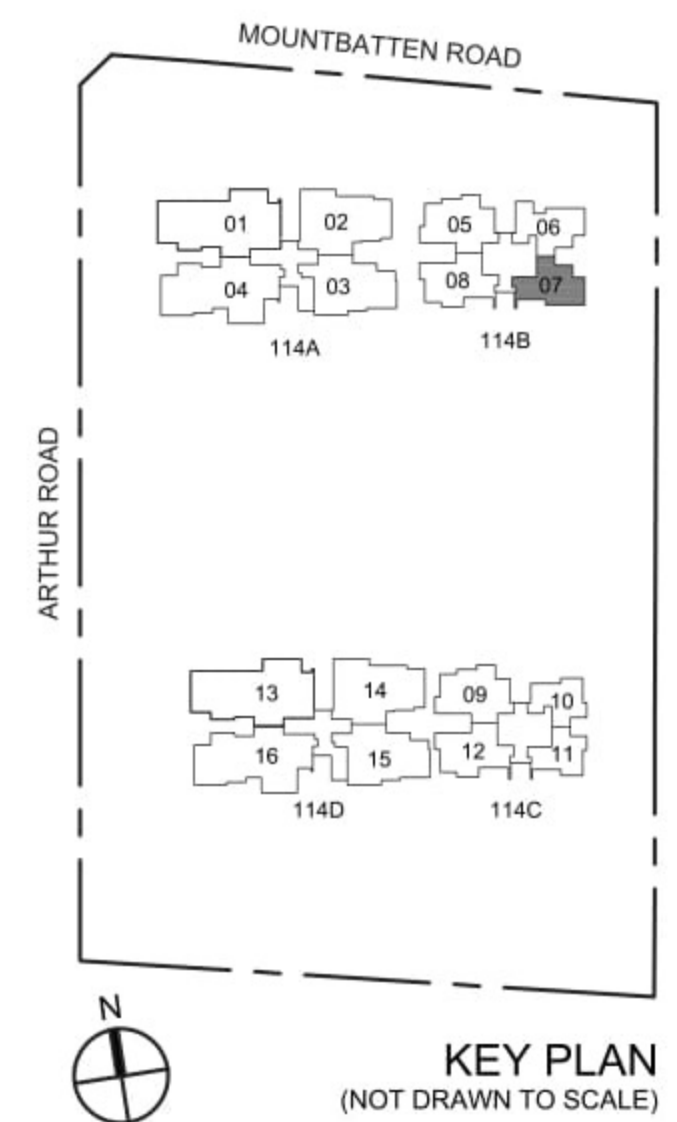

2 Bedroom

TYPE B1(a)

63 sqm / 678 sqft

(114B) #02-07 to #10-07

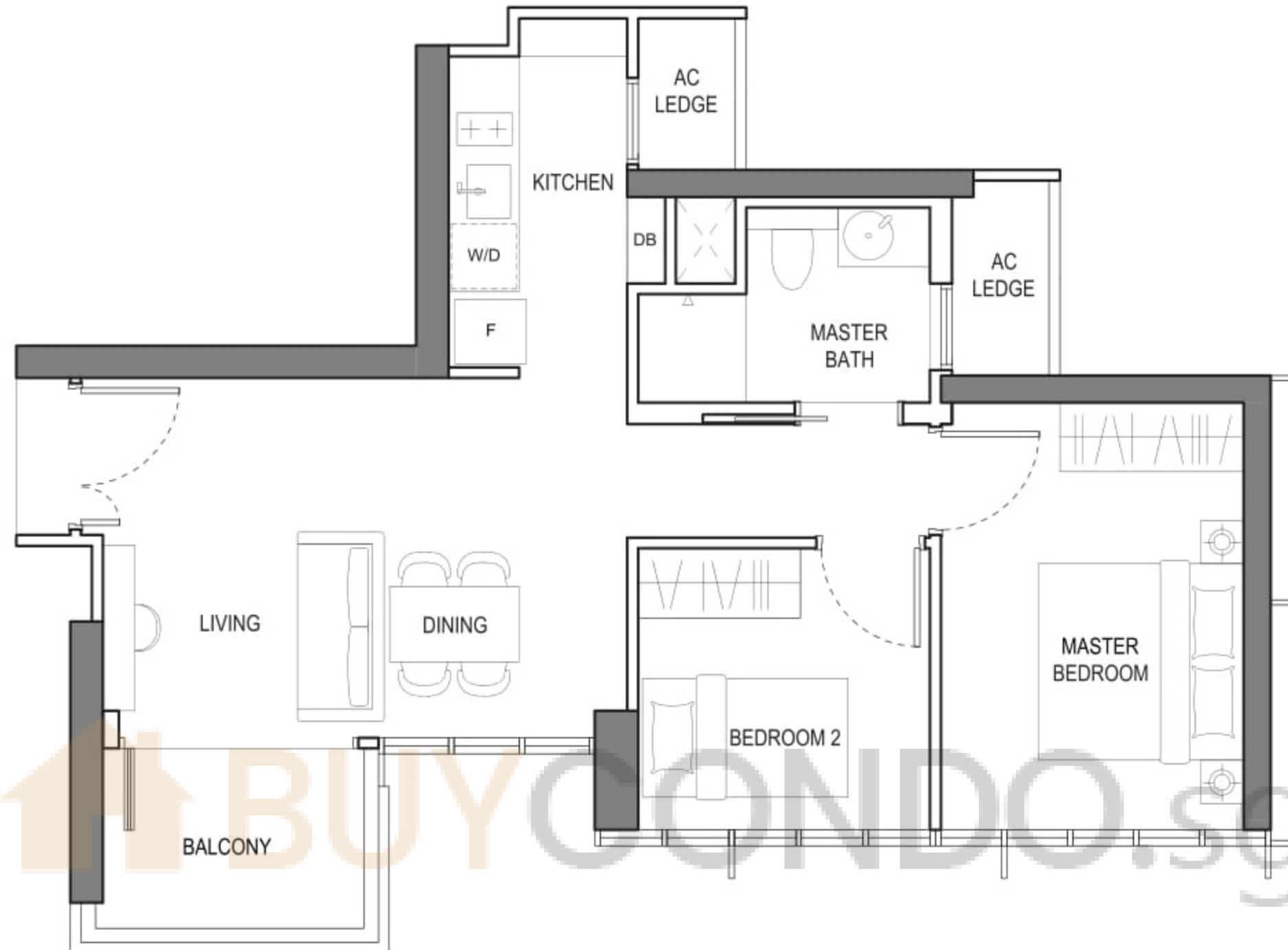

(114B) #02-07 to #03-07, #06-07 to #08-07

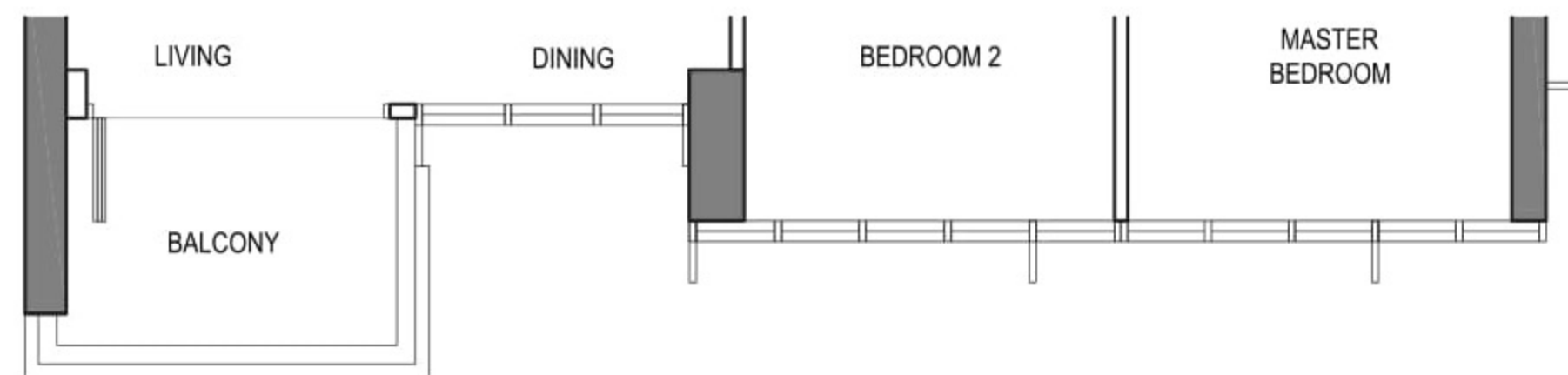

(114B) #04-07 to #05-07, #09-07 to #10-07

LEGEND:

W/D	WASHER CUM DRYER	F	FRIDGE	O	OVEN (BELOW HOB)
DB	DISTRIBUTION BOX		VOID SPACE (EXCLUDED FROM THE STRATA AREA)		AC LEDGE

NOTE:
 AREA INCLUDES A/C LEDGE AND BALCONY WHERE APPLICABLE. THE ABOVE PLANS AND ILLUSTRATIONS ARE SUBJECT TO CHANGE AS MAYBE REQUIRED OR APPROVED BY THE RELEVANT AUTHORITIES. ALL FLOOR AREAS ARE APPROXIMATE ONLY AND SUBJECT TO FINAL SURVEY. PLEASE REFER TO KEY PLAN FOR ORIENTATION. FOR AN ILLUSTRATION OF THE APPROVED BALCONY SCREEN, PLEASE REFER TO "BALCONY SCREEN" PAGE IN THIS BROCHURE.

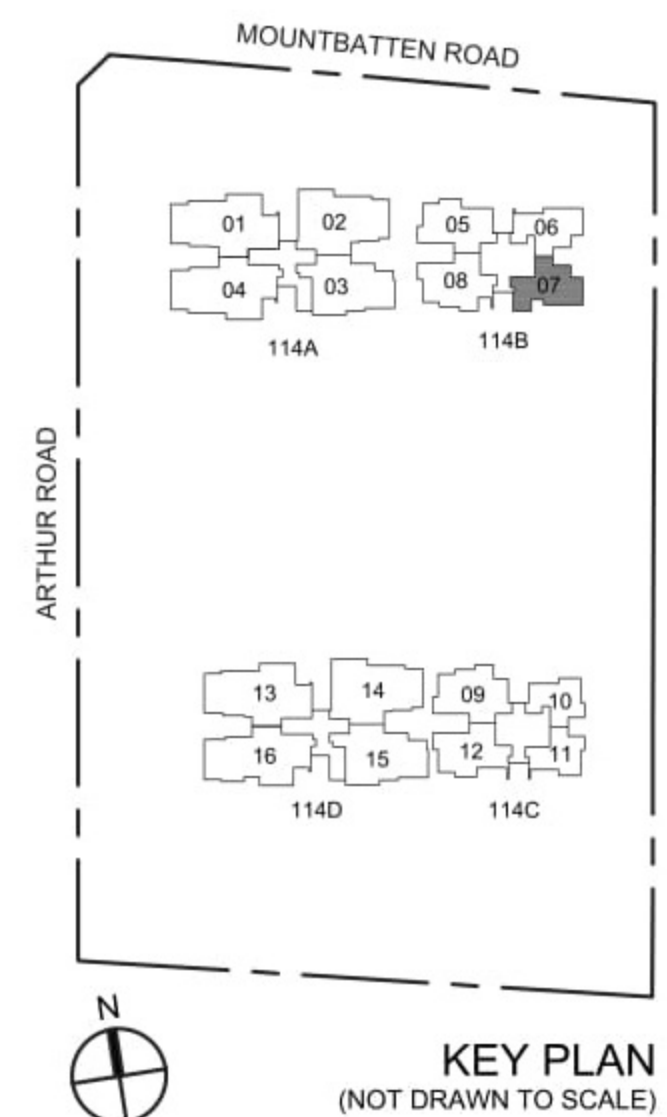

KEY PLAN
 (NOT DRAWN TO SCALE)

2 Bedroom





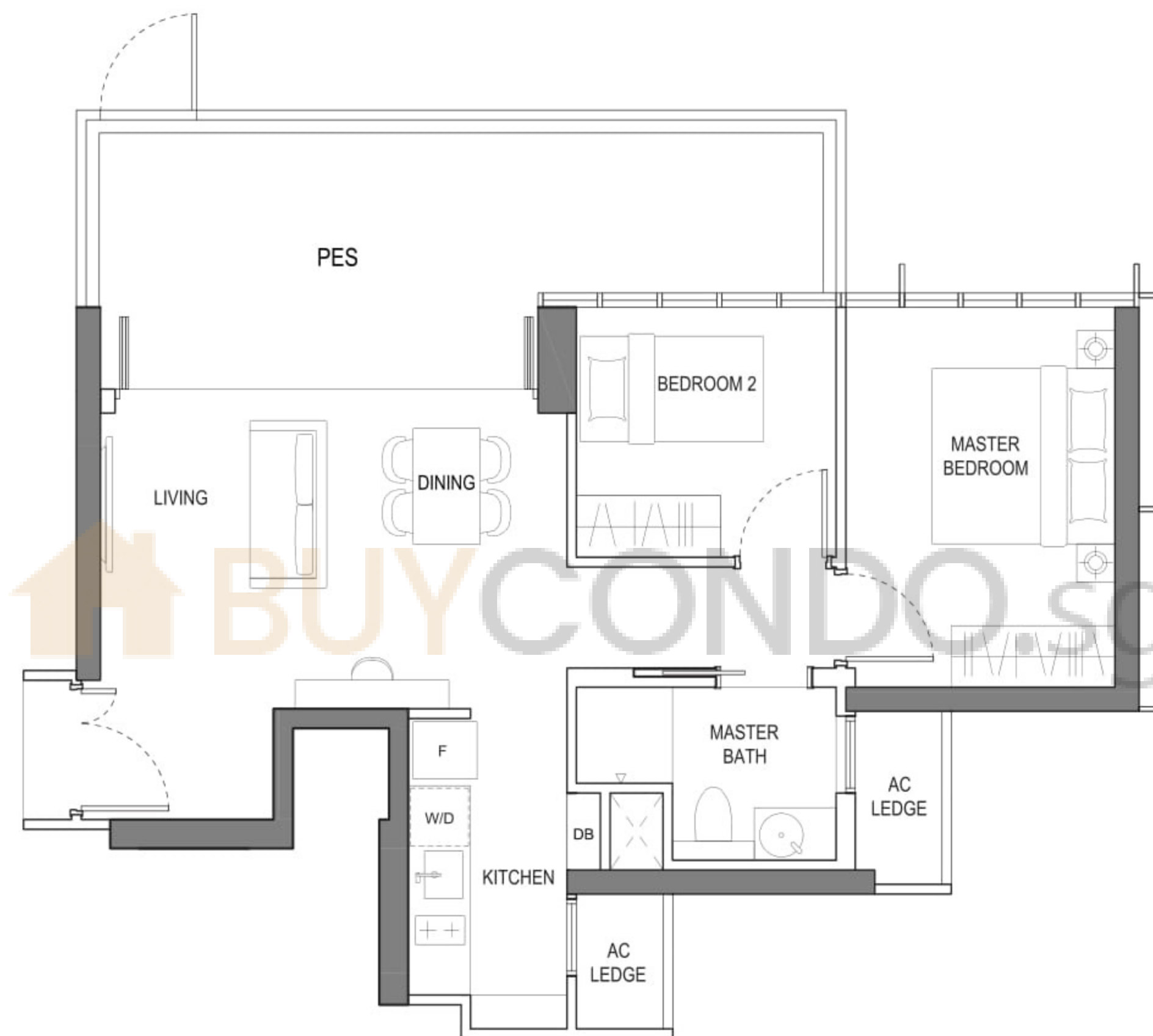

TYPE B2(p)

79 sqm / 850 sqft

(114B) #01-06



LEGEND:

 W/D	WASHER CUM DRYER	 F	FRIDGE	 O	OVEN (BELOW HOB)
 DB	DISTRIBUTION BOX		VOID SPACE (EXCLUDED FROM THE STRATA AREA)		AC LEDGE

NOTE:
 AREA INCLUDES A/C LEDGE AND BALCONY WHERE APPLICABLE. THE ABOVE PLANS AND ILLUSTRATIONS ARE SUBJECT TO CHANGE AS MAYBE REQUIRED OR APPROVED BY THE RELEVANT AUTHORITIES. ALL FLOOR AREAS ARE APPROXIMATE ONLY AND SUBJECT TO FINAL SURVEY. PLEASE REFER TO KEY PLAN FOR ORIENTATION. FOR AN ILLUSTRATION OF THE APPROVED BALCONY SCREEN, PLEASE REFER TO "BALCONY SCREEN" PAGE IN THIS BROCHURE.

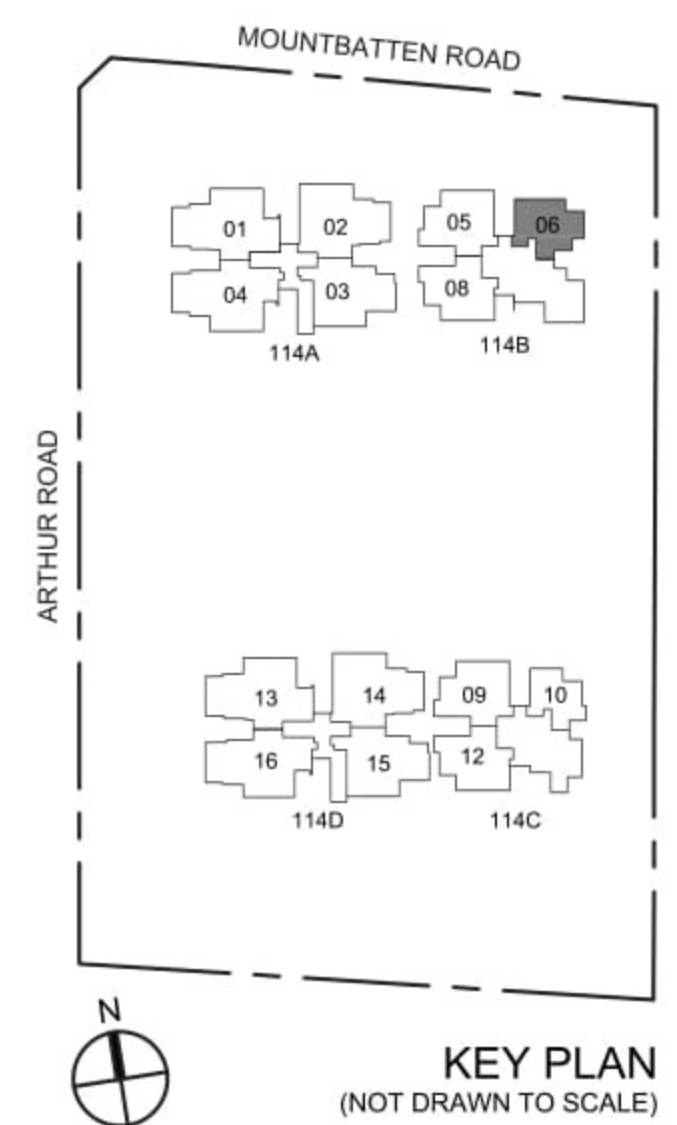

2 Bedroom

TYPE B2

60 sqm / 646 sqft

(114B) #02-06 to #10-06

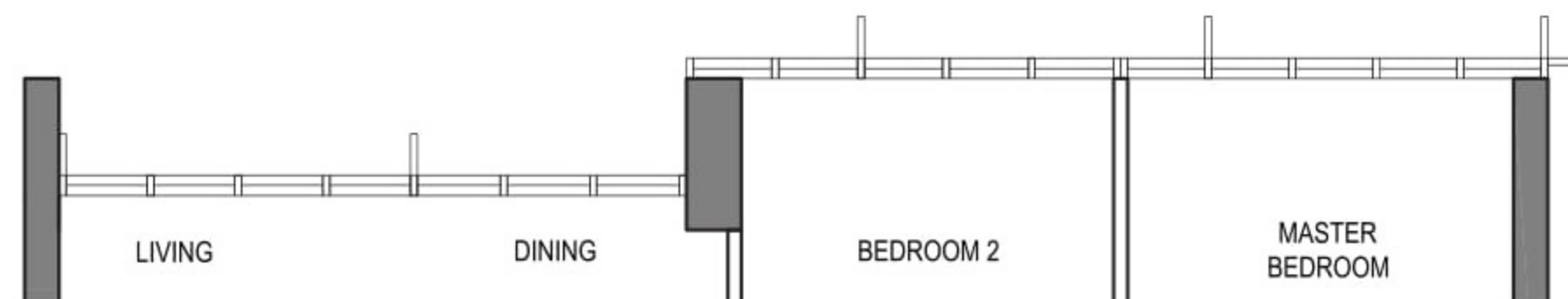



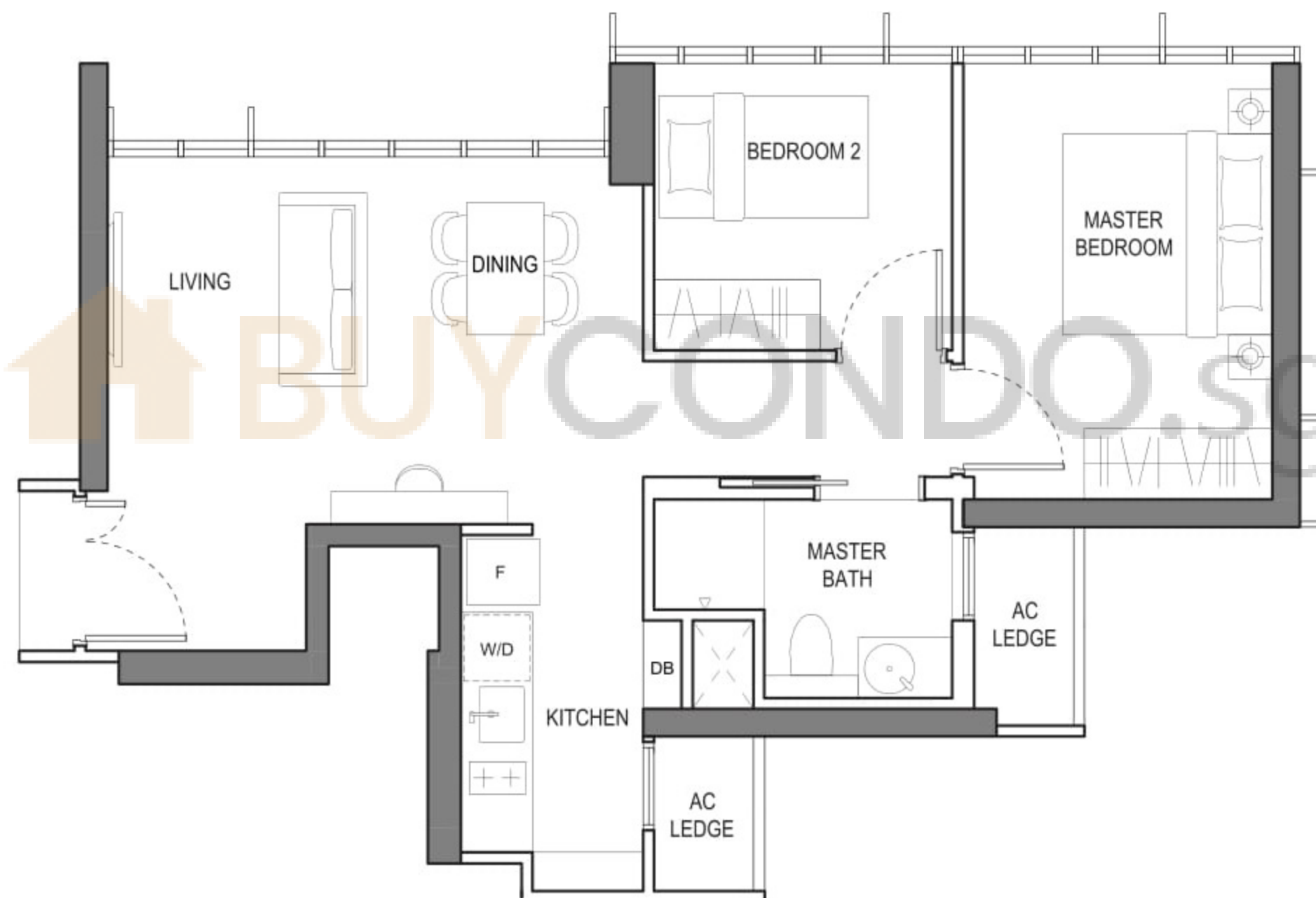



(114B) #04-06 to #05-06, #09-06 to #10-06



(114B) #02-06 to #03-06, #06-06 to #08-06

LEGEND:

 W/D	WASHER CUM DRYER	 F	FRIDGE	 O	OVEN (BELOW HOB)
 DB	DISTRIBUTION BOX		VOID SPACE (EXCLUDED FROM THE STRATA AREA)		AC LEDGE

NOTE:
 AREA INCLUDES A/C LEDGE AND BALCONY WHERE APPLICABLE. THE ABOVE PLANS AND ILLUSTRATIONS ARE SUBJECT TO CHANGE AS MAYBE REQUIRED OR APPROVED BY THE RELEVANT AUTHORITIES. ALL FLOOR AREAS ARE APPROXIMATE ONLY AND SUBJECT TO FINAL SURVEY. PLEASE REFER TO KEY PLAN FOR ORIENTATION. FOR AN ILLUSTRATION OF THE APPROVED BALCONY SCREEN, PLEASE REFER TO "BALCONY SCREEN" PAGE IN THIS BROCHURE.

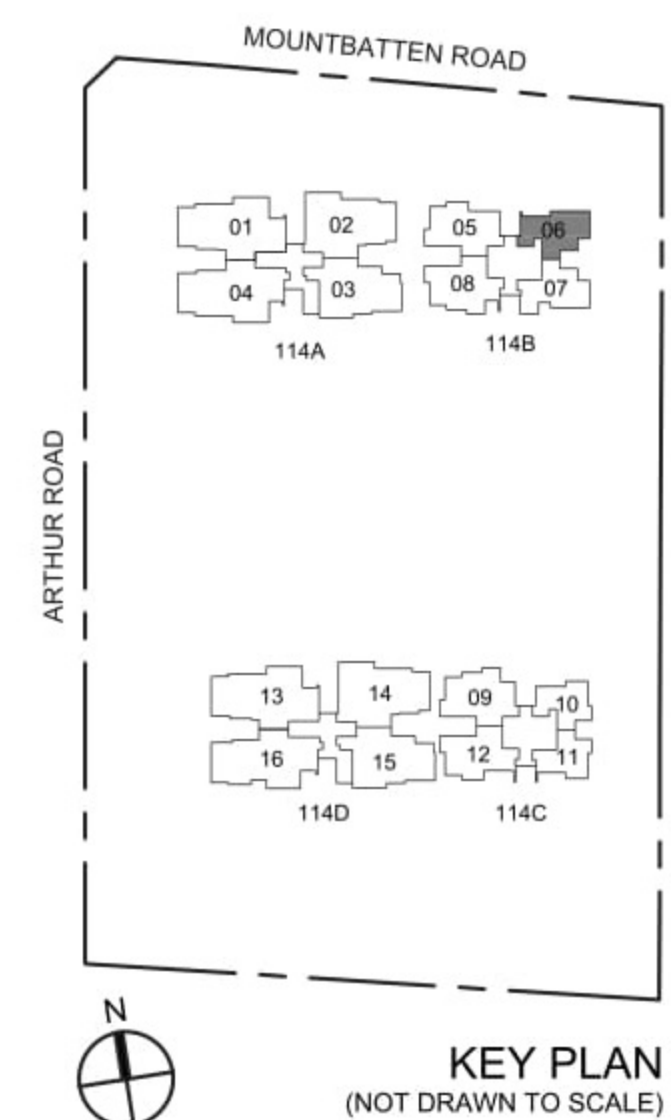

2 Bedroom

TYPE B2(a)

66 sqm / 710 sqft

(114B) #11-06 to #19-06

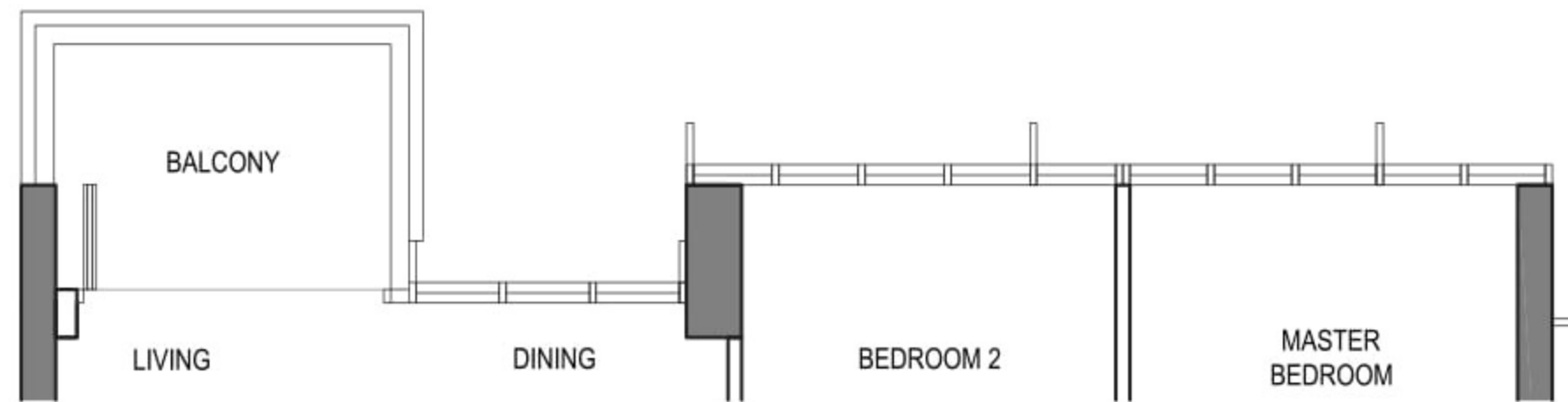

(114B) #14-06 to #19-06

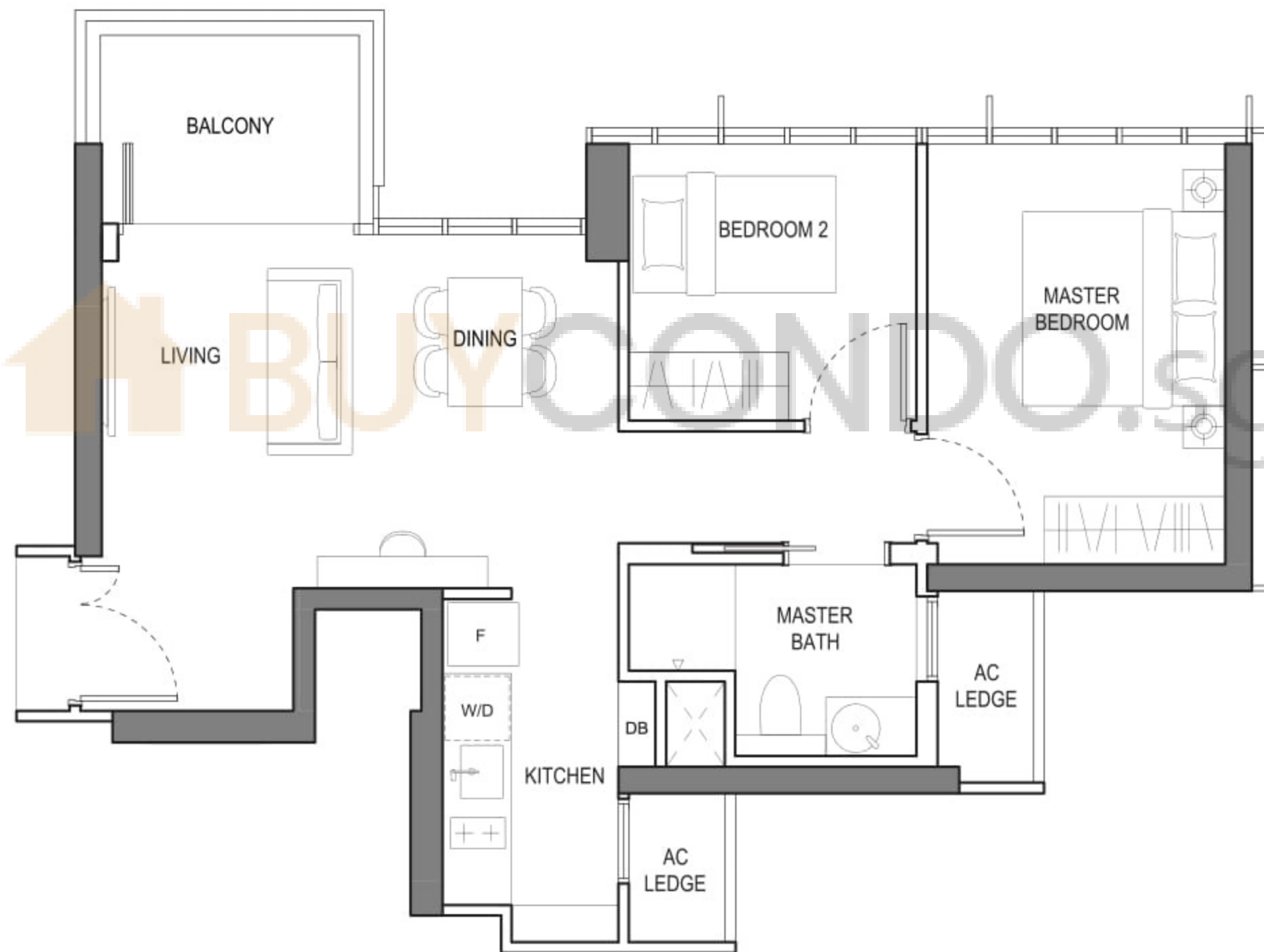

(114B) #11-06 to #13-06

LEGEND:

- W/D
 - F
 - O
 - DB
 - VOID SPACE (EXCLUDED FROM THE STRATA AREA)
 - AC LEDGE
- W/D WASHER CUM DRYER F FRIDGE O OVEN (BELOW HOB)
 DB DISTRIBUTION BOX VOID SPACE (EXCLUDED FROM THE STRATA AREA) AC LEDGE AC LEDGE

NOTE:
 AREA INCLUDES A/C LEDGE AND BALCONY WHERE APPLICABLE. THE ABOVE PLANS AND ILLUSTRATIONS ARE SUBJECT TO CHANGE AS MAYBE REQUIRED OR APPROVED BY THE RELEVANT AUTHORITIES. ALL FLOOR AREAS ARE APPROXIMATE ONLY AND SUBJECT TO FINAL SURVEY. PLEASE REFER TO KEY PLAN FOR ORIENTATION. FOR AN ILLUSTRATION OF THE APPROVED BALCONY SCREEN, PLEASE REFER TO "BALCONY SCREEN" PAGE IN THIS BROCHURE.

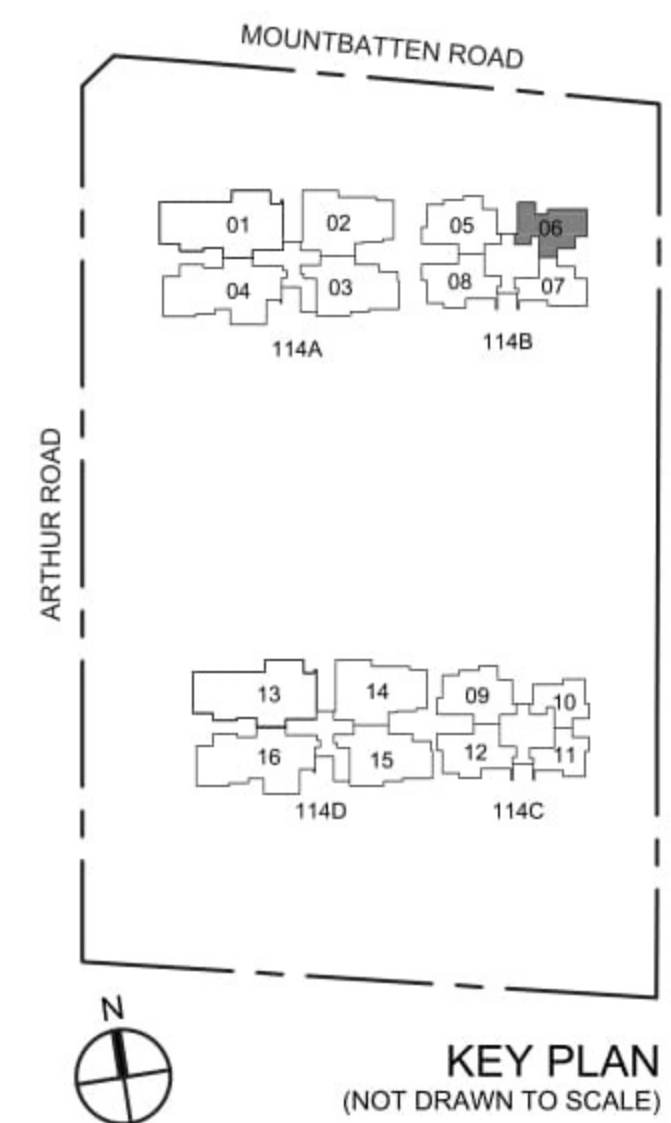

2 Bedroom Deluxe

TYPE B3(p)

92 sqm / 990 sqft

(114B) #01-08

(114C) #01-12

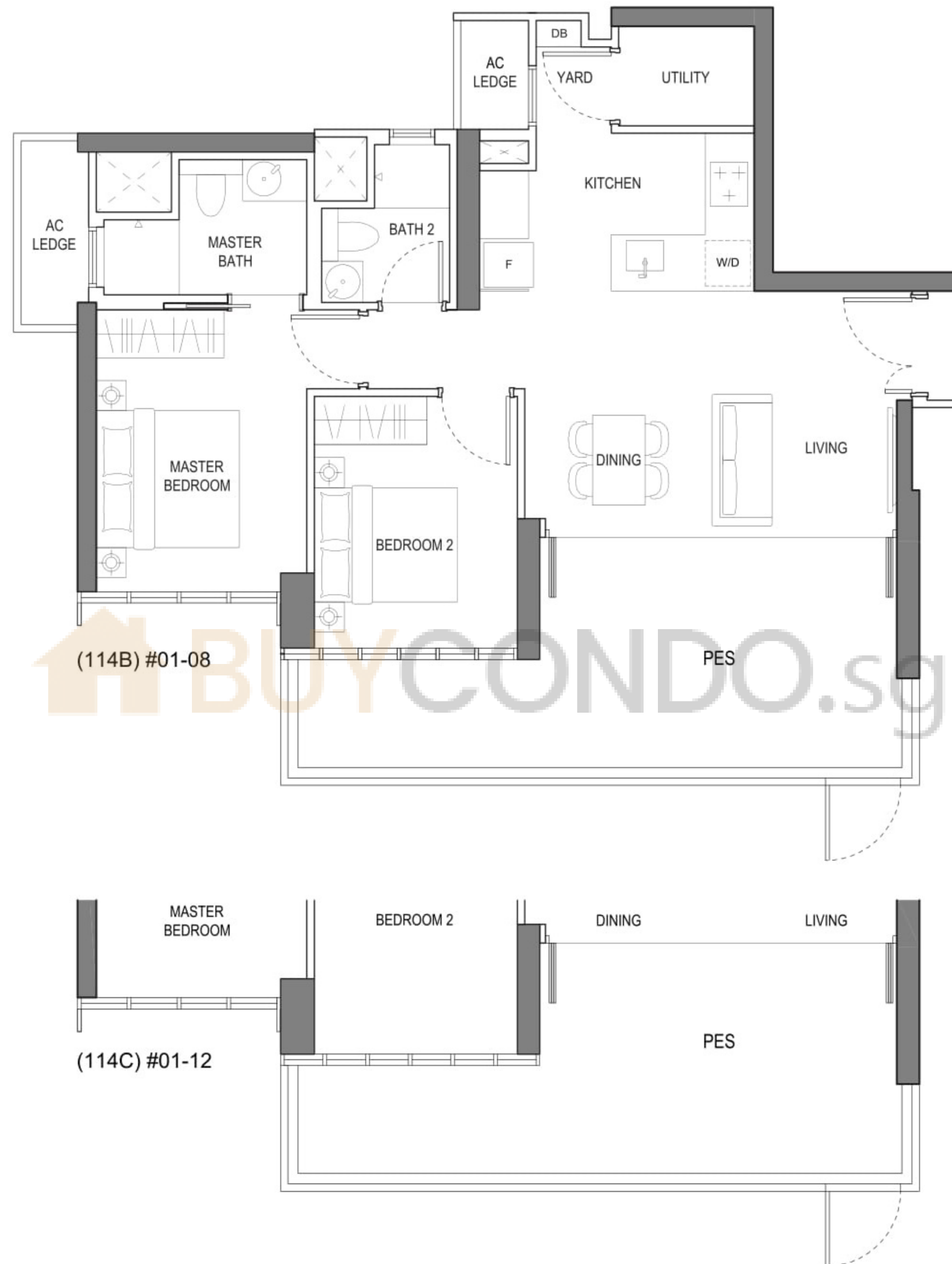

LEGEND:

- W/D WASHER CUM DRYER
- DB DISTRIBUTION BOX
- F FRIDGE
- X VOID SPACE (EXCLUDED FROM THE STRATA AREA)
- o OVEN (BELOW HOB)
- AC LEDGE AC LEDGE

NOTE:
 AREA INCLUDES A/C LEDGE AND BALCONY WHERE APPLICABLE. THE ABOVE PLANS AND ILLUSTRATIONS ARE SUBJECT TO CHANGE AS MAYBE REQUIRED OR APPROVED BY THE RELEVANT AUTHORITIES. ALL FLOOR AREAS ARE APPROXIMATE ONLY AND SUBJECT TO FINAL SURVEY. PLEASE REFER TO KEY PLAN FOR ORIENTATION. FOR AN ILLUSTRATION OF THE APPROVED BALCONY SCREEN, PLEASE REFER TO "BALCONY SCREEN" PAGE IN THIS BROCHURE.

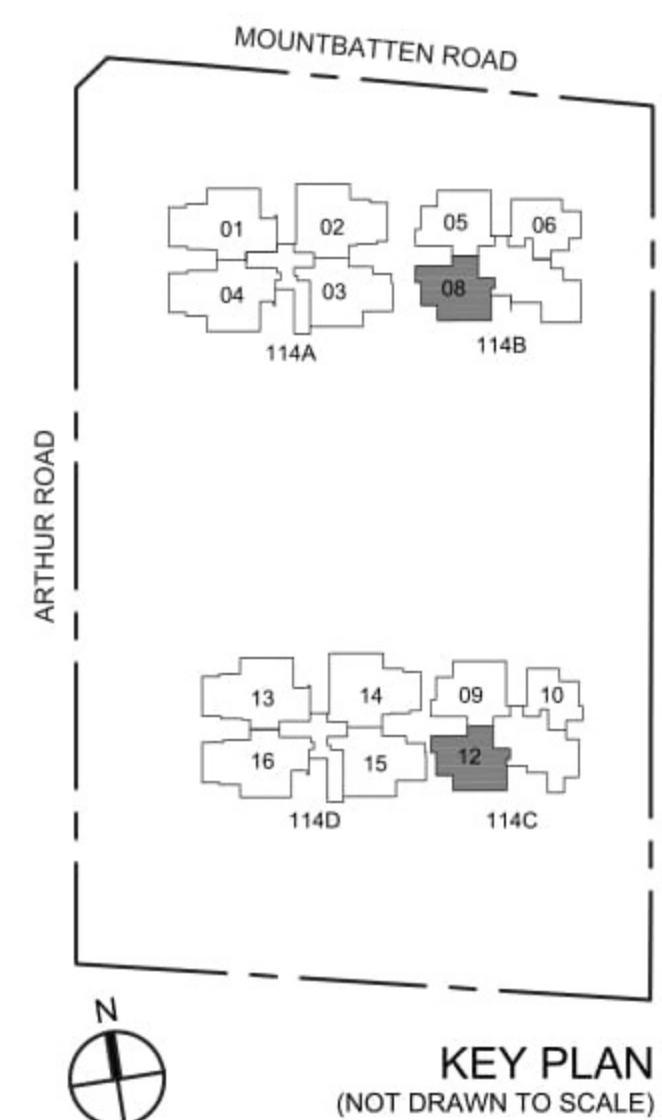

KEY PLAN
 (NOT DRAWN TO SCALE)

2 Bedroom Deluxe

TYPE B3

70 sqm / 753 sqft

(114B) #11-08 to #19-08

(114C) #02-12 to #10-12, #13-12 to #20-12

(114B)
#11-08 to #13-08

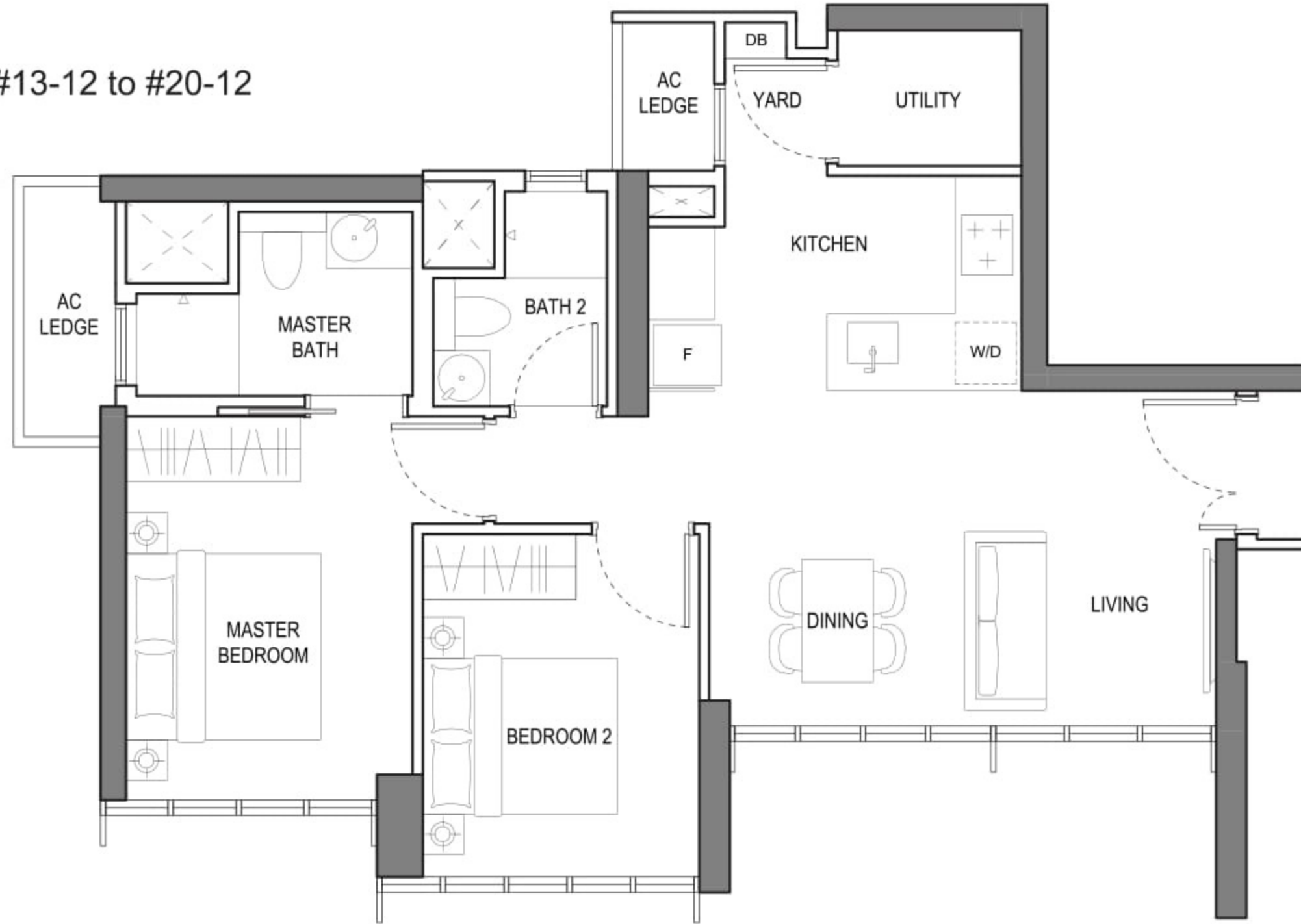

(114B)
#14-08 to #19-08

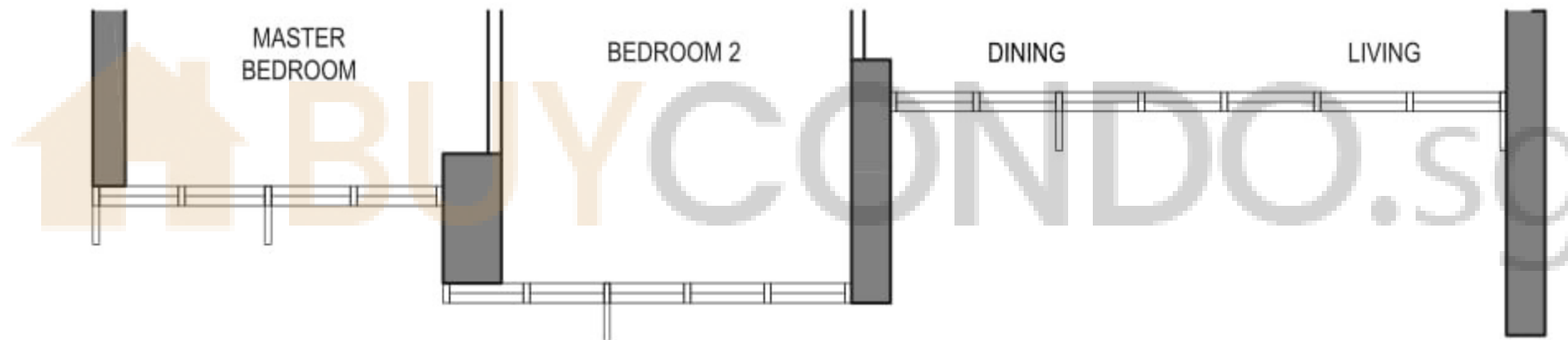

(114C)
#02-12,
#05-12 to #07-12,
#13-12 to #19-12

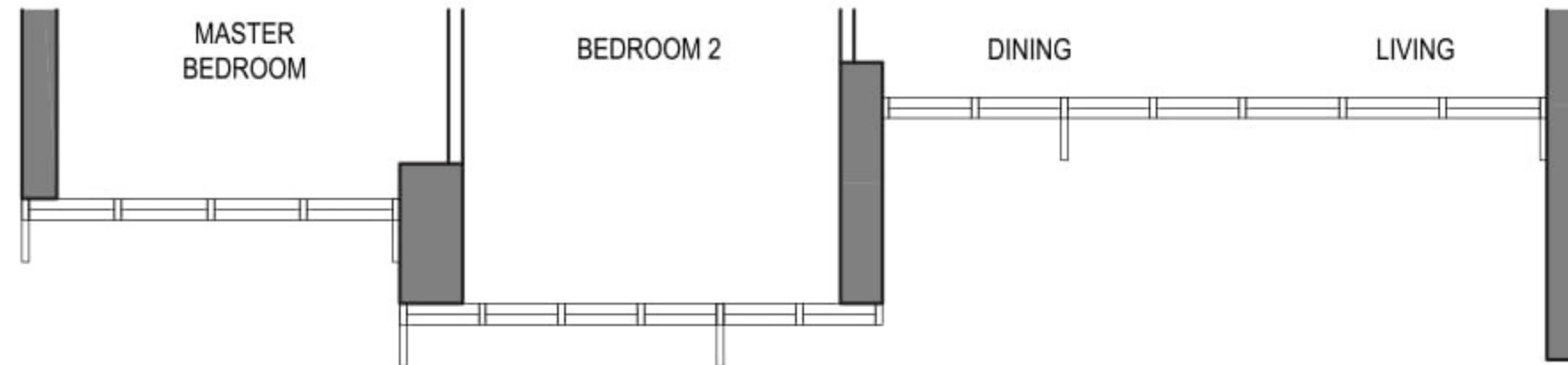

(114C)
#03-12 to #04-12,
#08-12 to #10-12

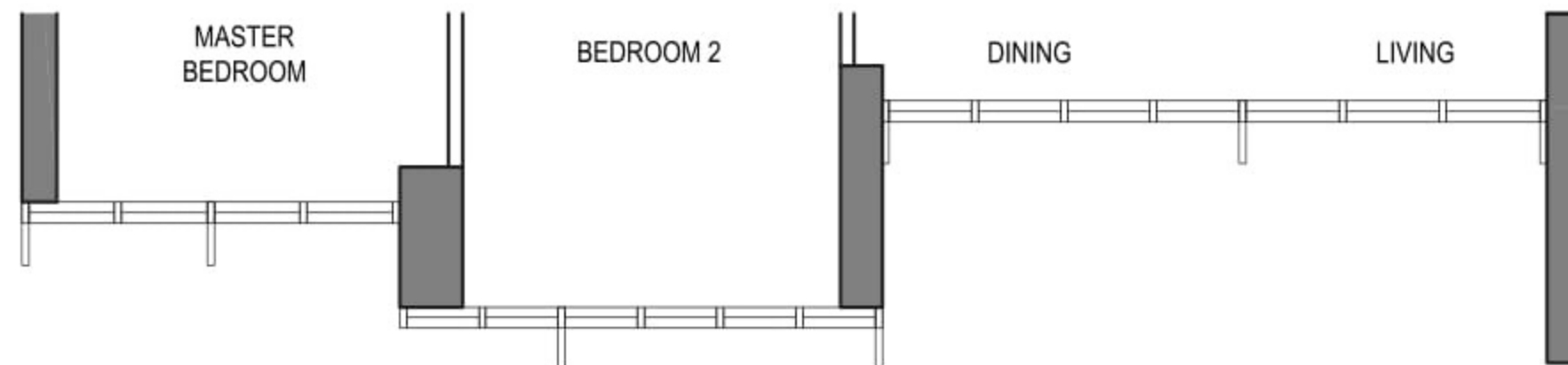

(114C)
#20-12

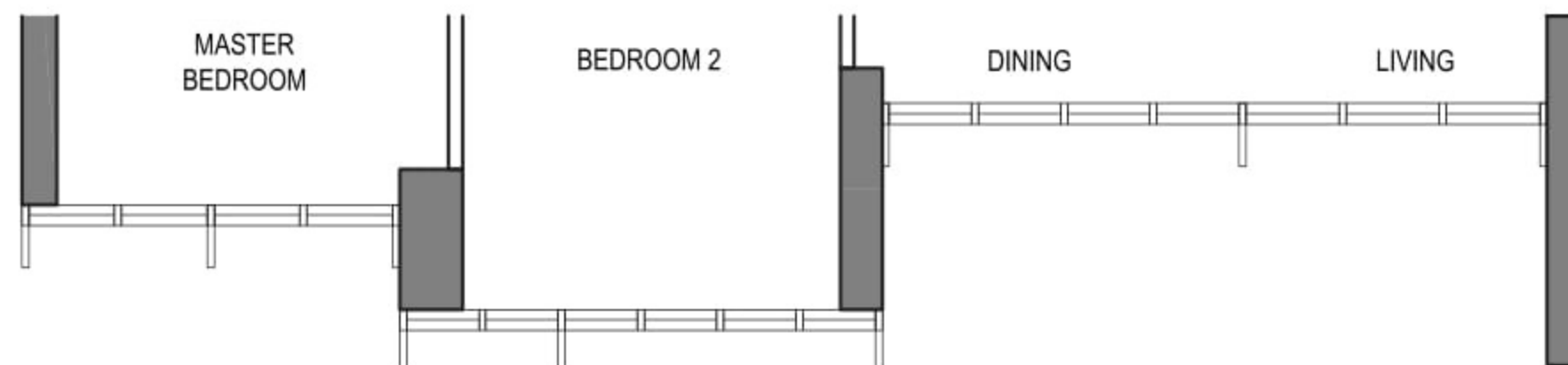

LEGEND:

W/D	WASHER CUM DRYER	F	FRIDGE	O	OVEN (BELOW HOB)
DB	DISTRIBUTION BOX		VOID SPACE (EXCLUDED FROM THE STRATA AREA)	AC LEDGE	AC LEDGE

NOTE:
AREA INCLUDES A/C LEDGE AND BALCONY WHERE APPLICABLE. THE ABOVE PLANS AND ILLUSTRATIONS ARE SUBJECT TO CHANGE AS MAYBE REQUIRED OR APPROVED BY THE RELEVANT AUTHORITIES. ALL FLOOR AREAS ARE APPROXIMATE ONLY AND SUBJECT TO FINAL SURVEY. PLEASE REFER TO KEY PLAN FOR ORIENTATION. FOR AN ILLUSTRATION OF THE APPROVED BALCONY SCREEN, PLEASE REFER TO "BALCONY SCREEN" PAGE IN THIS BROCHURE.

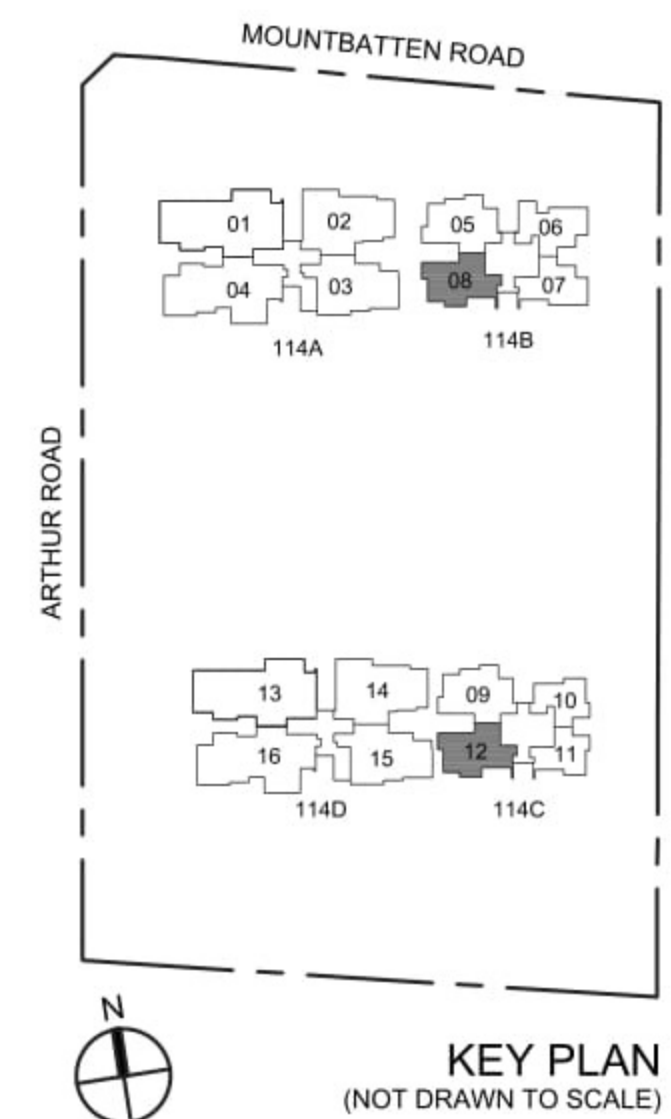

2 Bedroom Deluxe

TYPE B3(a)

76 sqm / 818 sqft

(114B) #02-08 to #10-08

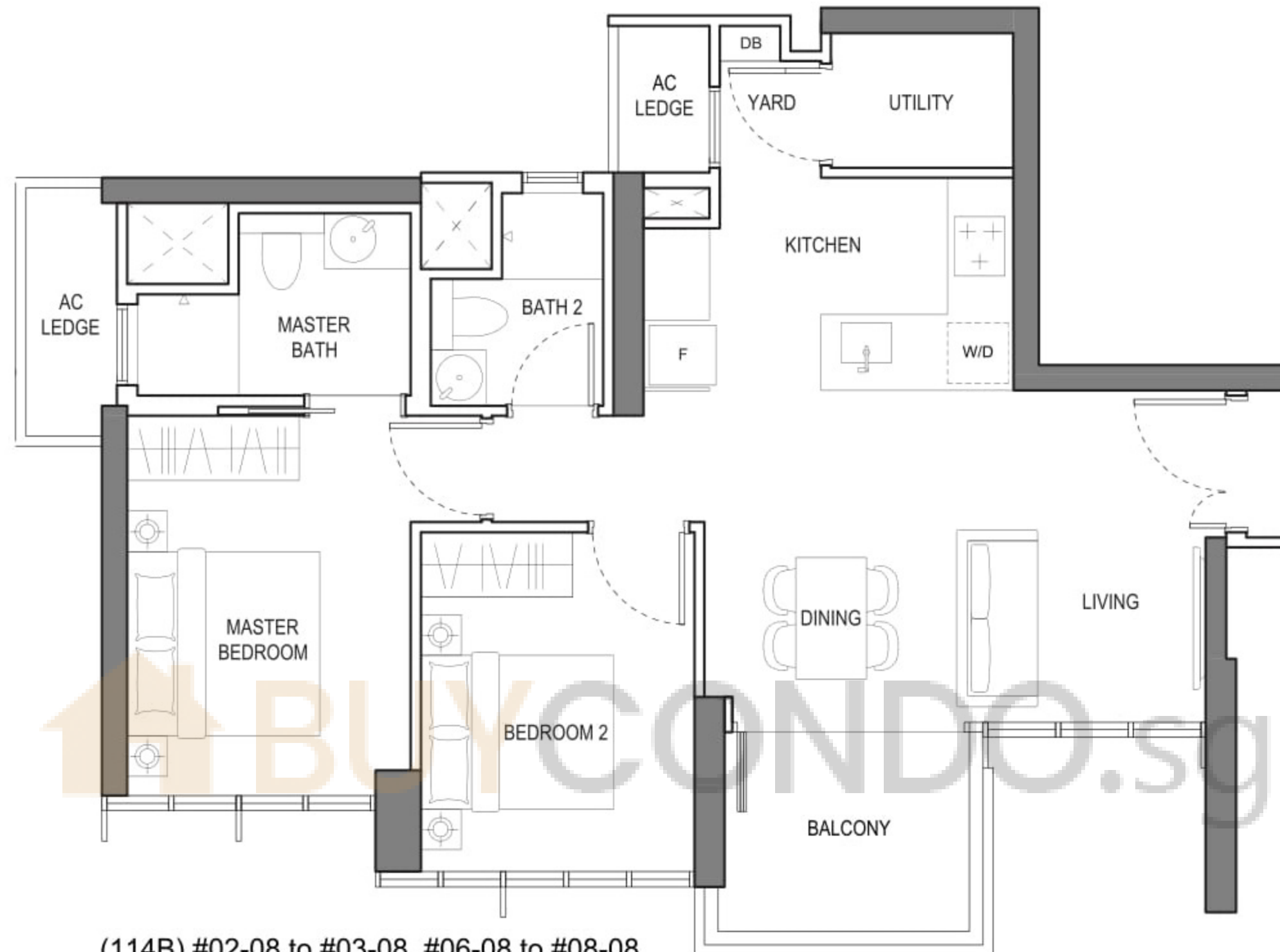

(114B) #02-08 to #03-08, #06-08 to #08-08

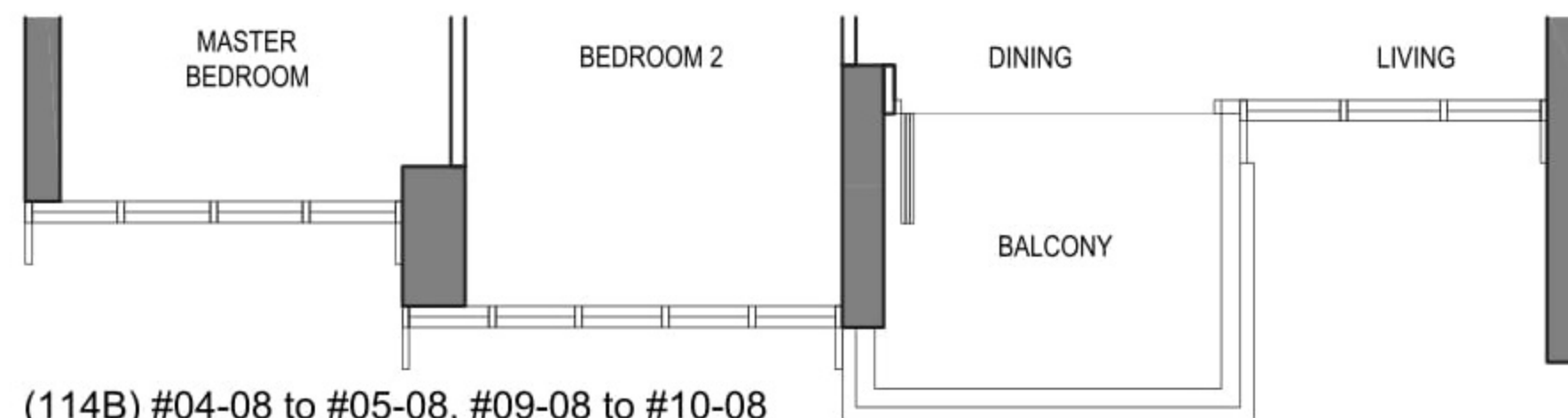

(114B) #04-08 to #05-08, #09-08 to #10-08

LEGEND:

W/D WASHER CUM DRYER	F FRIDGE	O OVEN (BELOW HOB)
DB DISTRIBUTION BOX	VOID SPACE (EXCLUDED FROM THE STRATA AREA)	AC LEDGE AC LEDGE

NOTE:
 AREA INCLUDES A/C LEDGE AND BALCONY WHERE APPLICABLE. THE ABOVE PLANS AND ILLUSTRATIONS ARE SUBJECT TO CHANGE AS MAYBE REQUIRED OR APPROVED BY THE RELEVANT AUTHORITIES. ALL FLOOR AREAS ARE APPROXIMATE ONLY AND SUBJECT TO FINAL SURVEY. PLEASE REFER TO KEY PLAN FOR ORIENTATION. FOR AN ILLUSTRATION OF THE APPROVED BALCONY SCREEN, PLEASE REFER TO "BALCONY SCREEN" PAGE IN THIS BROCHURE.

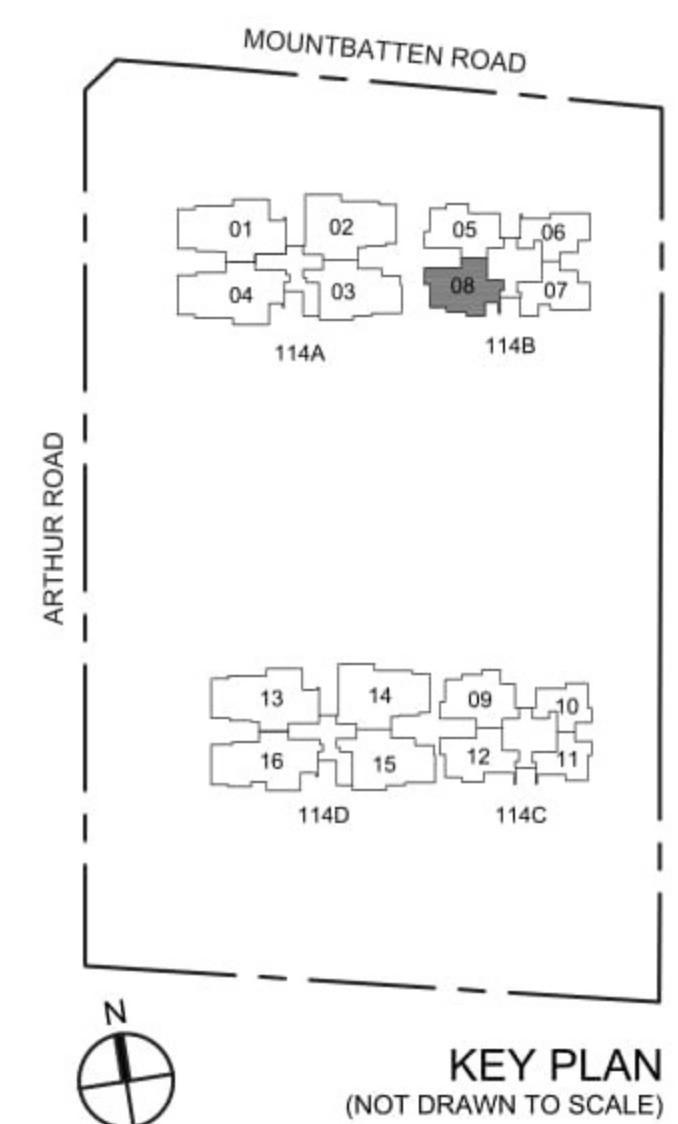

2 Bedroom Deluxe





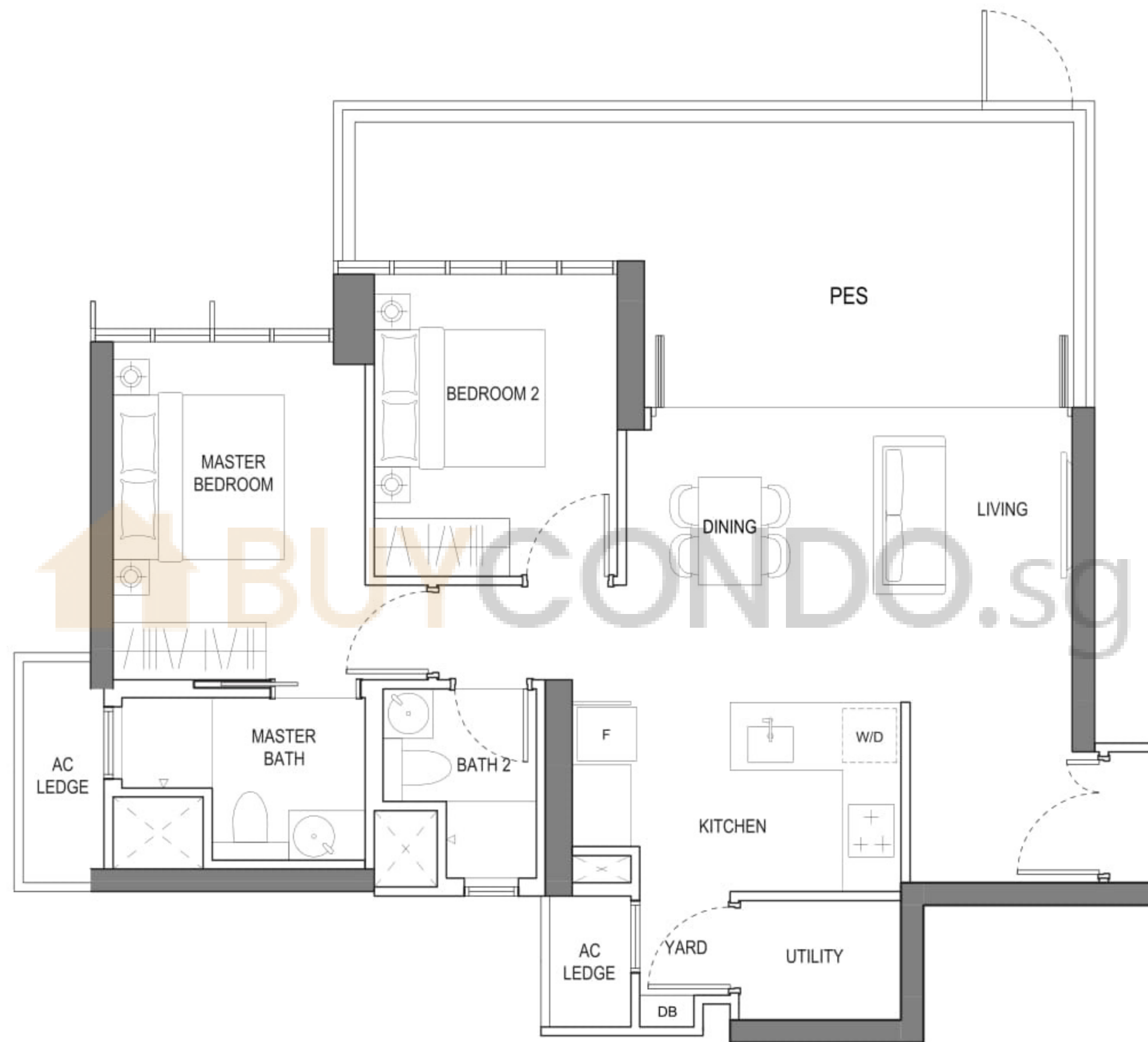

TYPE B4(p)

97 sqm / 1,044 sqft

(114B) #01-05
(114C) #01-09



LEGEND:

 W/D	WASHER CUM DRYER	 F	FRIDGE	 O	OVEN (BELOW HOB)
 DB	DISTRIBUTION BOX		VOID SPACE (EXCLUDED FROM THE STRATA AREA)		AC LEDGE

NOTE:
AREA INCLUDES A/C LEDGE AND BALCONY WHERE APPLICABLE. THE ABOVE PLANS AND ILLUSTRATIONS ARE SUBJECT TO CHANGE AS MAYBE REQUIRED OR APPROVED BY THE RELEVANT AUTHORITIES. ALL FLOOR AREAS ARE APPROXIMATE ONLY AND SUBJECT TO FINAL SURVEY. PLEASE REFER TO KEY PLAN FOR ORIENTATION. FOR AN ILLUSTRATION OF THE APPROVED BALCONY SCREEN, PLEASE REFER TO "BALCONY SCREEN" PAGE IN THIS BROCHURE.

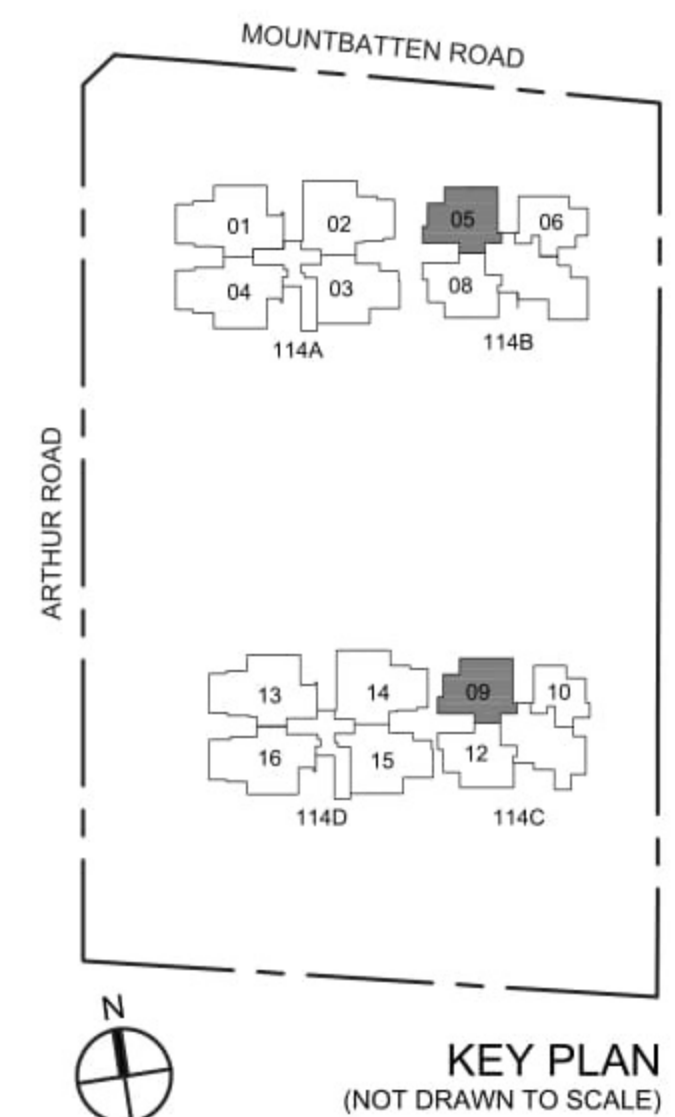

2 Bedroom Deluxe

TYPE B4

74 sqm / 796 sqft

(114B) #02-05 to #10-05

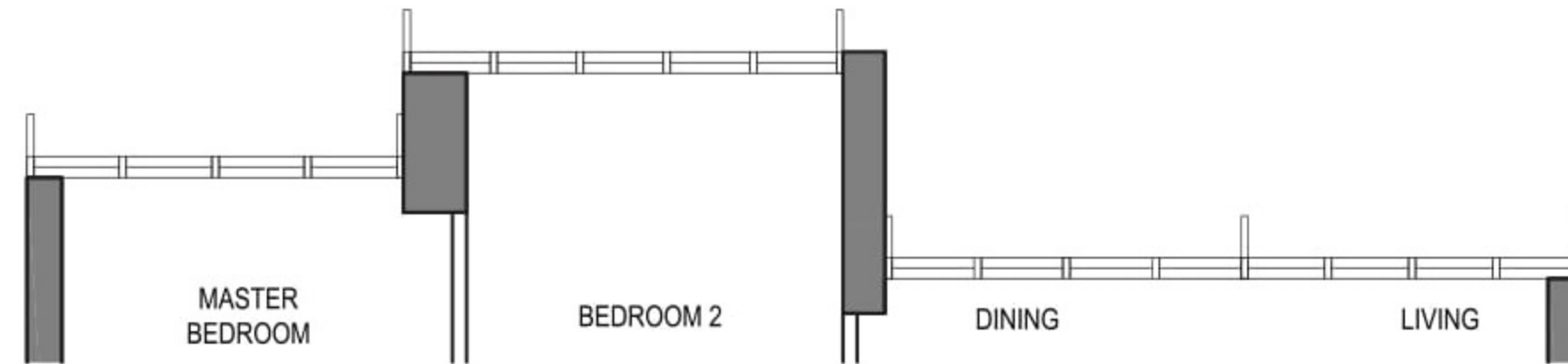



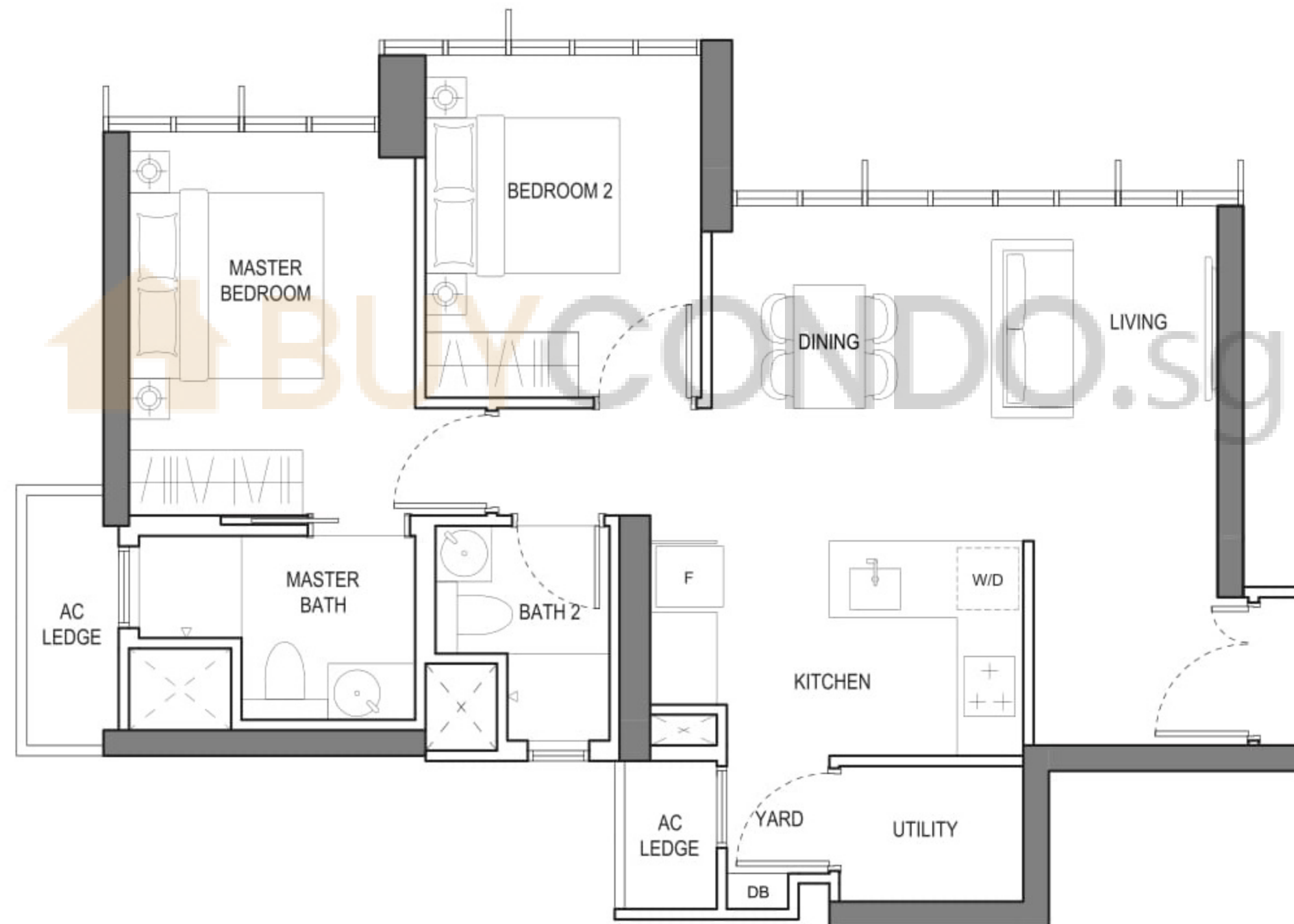



(114B) #04-05 to #05-05, #09-05 to #10-05

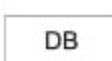

(114B) #02-05 to #03-05, #06-05 to #08-05

LEGEND:

 W/D	 F	 O
 DB	 VOID SPACE (EXCLUDED FROM THE STRATA AREA)	 AC LEDGE
		 OVEN (BELOW HOB)

NOTE:
AREA INCLUDES A/C LEDGE AND BALCONY WHERE APPLICABLE. THE ABOVE PLANS AND ILLUSTRATIONS ARE SUBJECT TO CHANGE AS MAYBE REQUIRED OR APPROVED BY THE RELEVANT AUTHORITIES. ALL FLOOR AREAS ARE APPROXIMATE ONLY AND SUBJECT TO FINAL SURVEY. PLEASE REFER TO KEY PLAN FOR ORIENTATION. FOR AN ILLUSTRATION OF THE APPROVED BALCONY SCREEN, PLEASE REFER TO "BALCONY SCREEN" PAGE IN THIS BROCHURE.

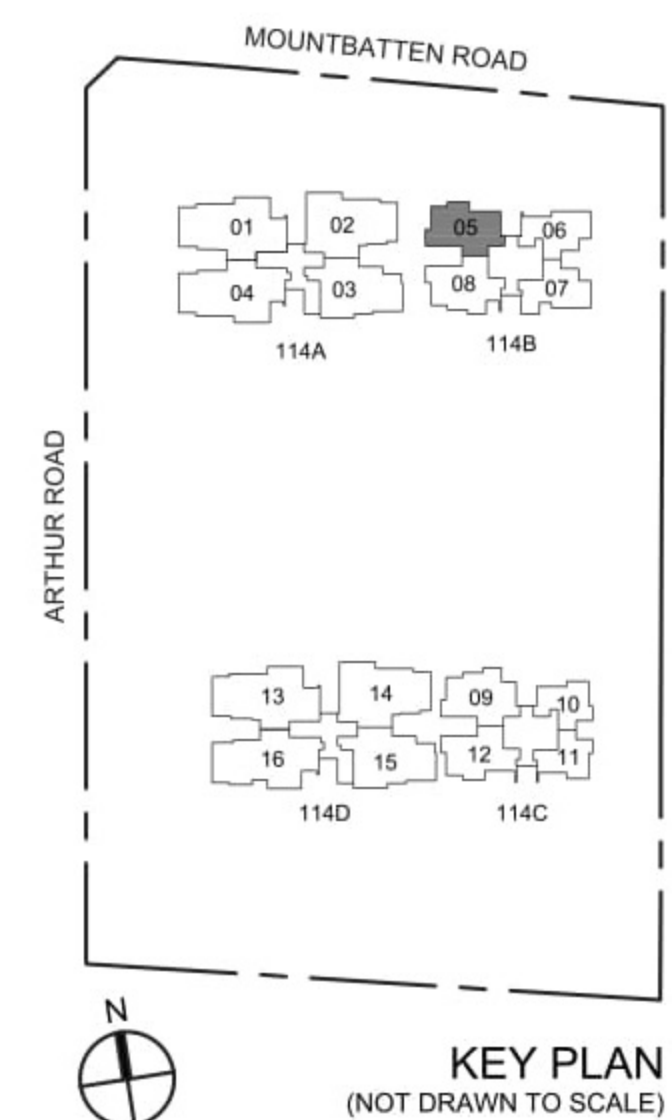

KEY PLAN
(NOT DRAWN TO SCALE)

2 Bedroom Deluxe

TYPE B4(a)

80 sqm / 861 sqft

(114B) #11-05 to #19-05
 (114C) #02-09 to #20-09

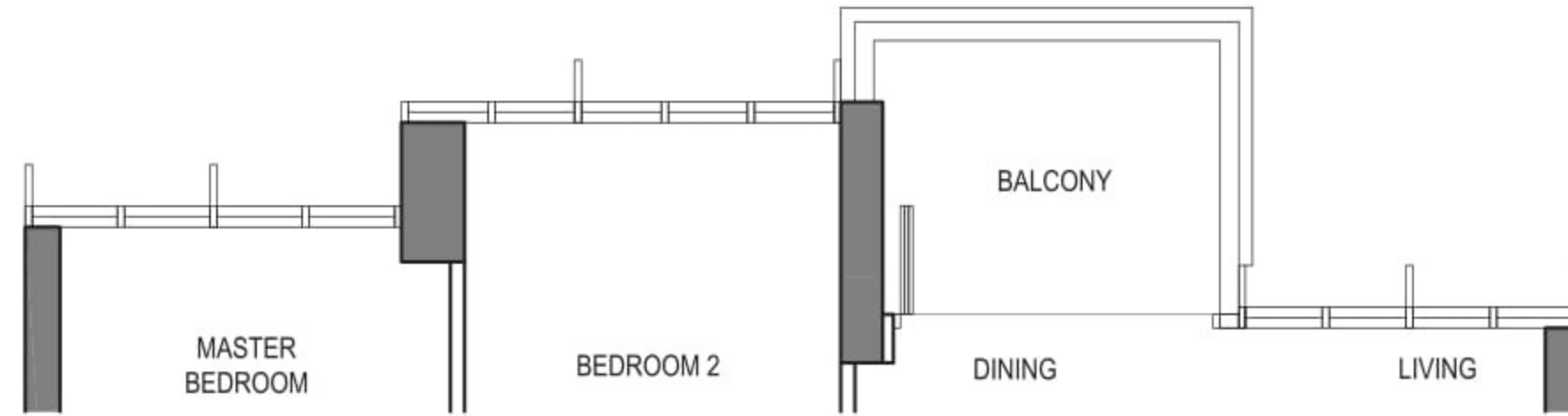



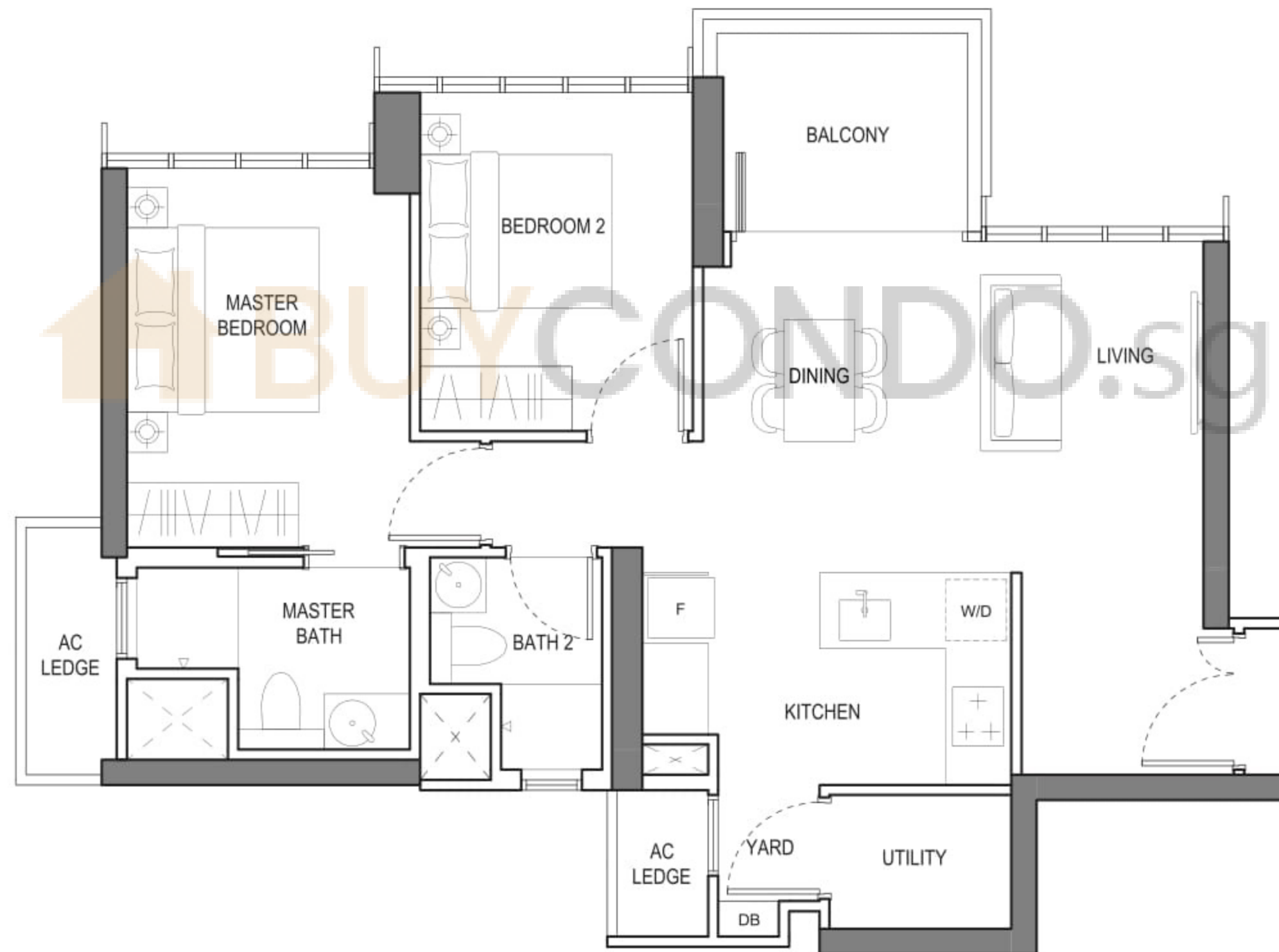



(114B) #14-05 to #19-05
 (114C) #02-09, #05-09 to #07-09, #13-09 to #19-09



(114B) #11-05 to #13-05
 (114C) #03-09 to #04-09, #08-09 to #12-09, #20-09

LEGEND:

 W/D	WASHER CUM DRYER	 F	FRIDGE	 O	OVEN (BELOW HOB)
 DB	DISTRIBUTION BOX		VOID SPACE (EXCLUDED FROM THE STRATA AREA)		AC LEDGE

NOTE:
 AREA INCLUDES A/C LEDGE AND BALCONY WHERE APPLICABLE. THE ABOVE PLANS AND ILLUSTRATIONS ARE SUBJECT TO CHANGE AS MAYBE REQUIRED OR APPROVED BY THE RELEVANT AUTHORITIES. ALL FLOOR AREAS ARE APPROXIMATE ONLY AND SUBJECT TO FINAL SURVEY. PLEASE REFER TO KEY PLAN FOR ORIENTATION. FOR AN ILLUSTRATION OF THE APPROVED BALCONY SCREEN, PLEASE REFER TO "BALCONY SCREEN" PAGE IN THIS BROCHURE.

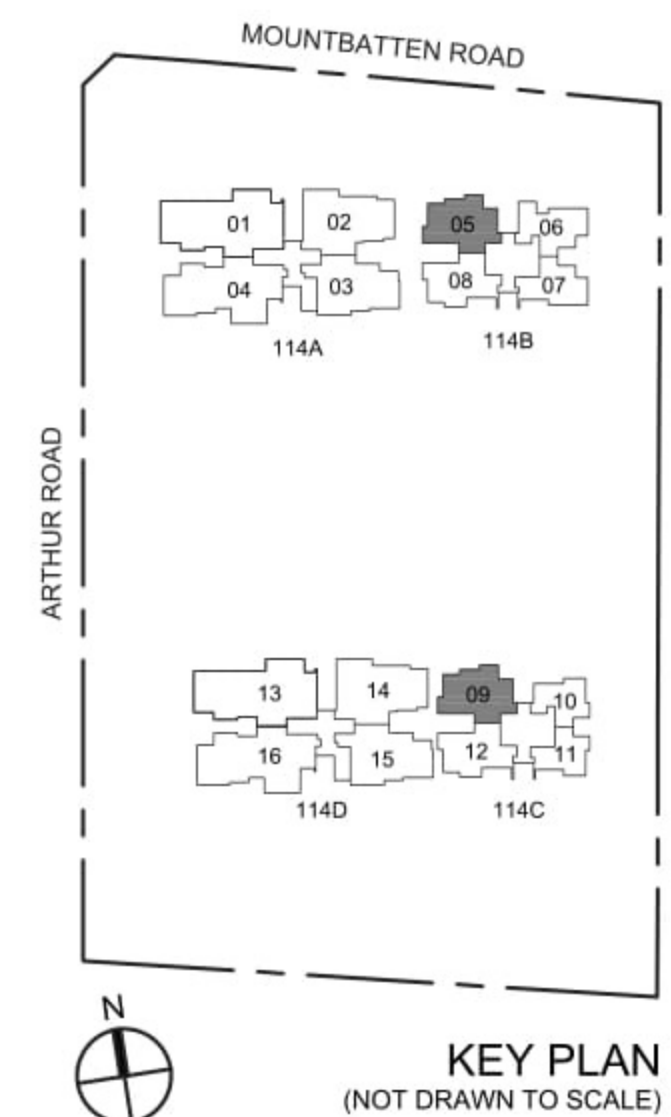

KEY PLAN
 (NOT DRAWN TO SCALE)

3 Bedroom

TYPE C1(p)



113 sqm / 1,216 sqft

(114A) #01-03

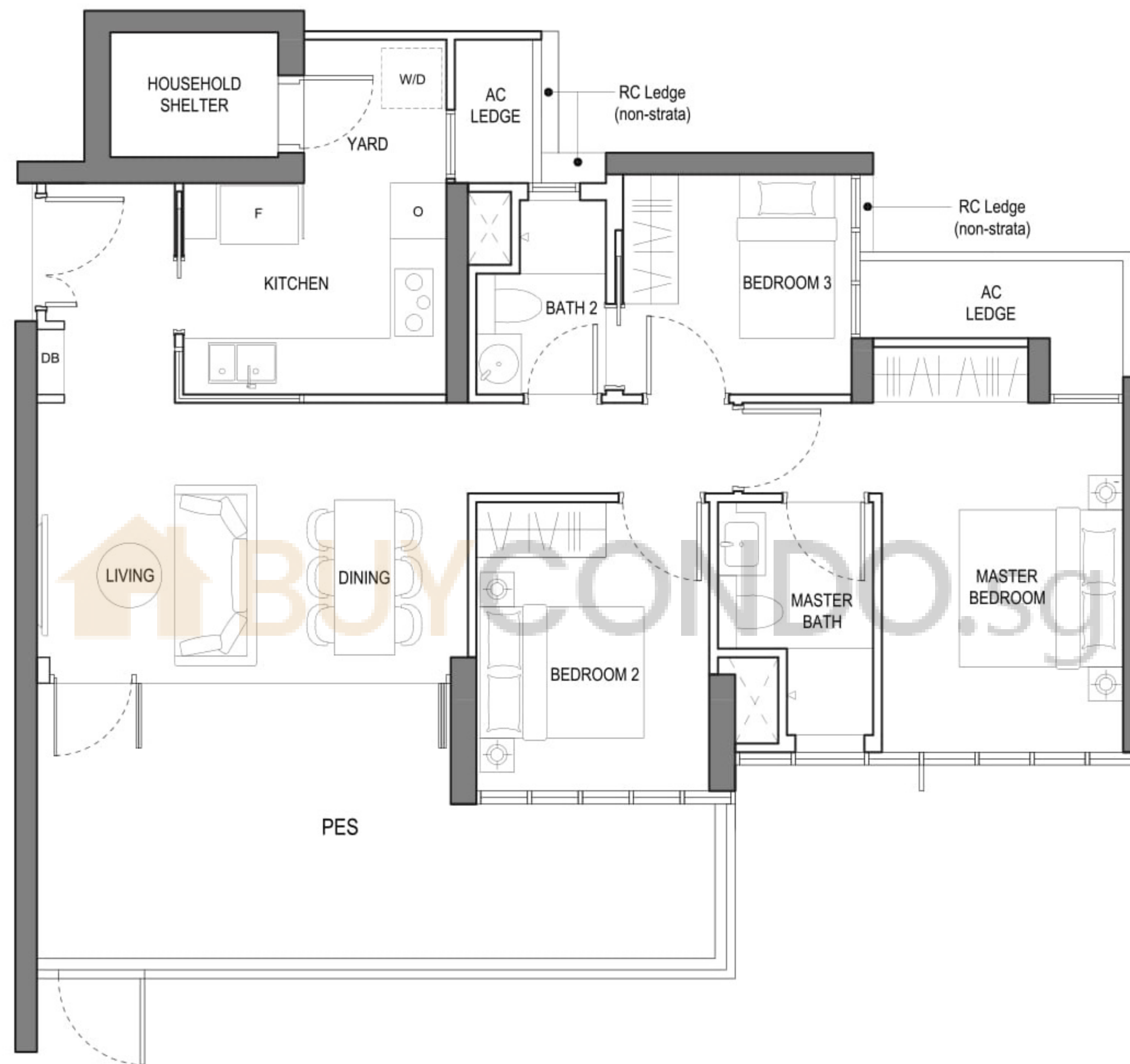
(114D) #01-15



LEGEND:

 W/D	WASHER CUM DRYER	 F	FRIDGE	 O	OVEN
 DB	DISTRIBUTION BOX		VOID SPACE (EXCLUDED FROM THE STRATA AREA)		AC LEDGE

NOTE:
 AREA INCLUDES A/C LEDGE AND BALCONY WHERE APPLICABLE. THE ABOVE PLANS AND ILLUSTRATIONS ARE SUBJECT TO CHANGE AS MAYBE REQUIRED OR APPROVED BY THE RELEVANT AUTHORITIES. ALL FLOOR AREAS ARE APPROXIMATE ONLY AND SUBJECT TO FINAL SURVEY. PLEASE REFER TO KEY PLAN FOR ORIENTATION. FOR AN ILLUSTRATION OF THE APPROVED BALCONY SCREEN, PLEASE REFER TO "BALCONY SCREEN" PAGE IN THIS BROCHURE.

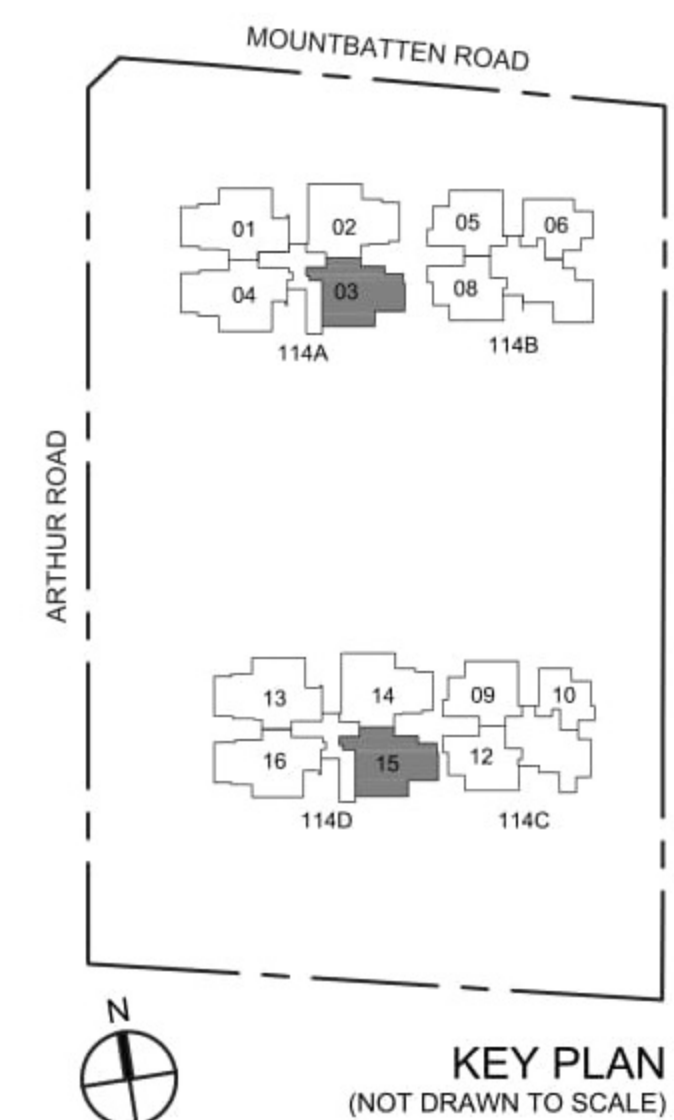

KEY PLAN
(NOT DRAWN TO SCALE)

3 Bedroom

TYPE C1

104 sqm / 1,119 sqft

(114A) #02-03 to #19-03

(114D) #02-15 to #10-15, #12-15 to #19-15

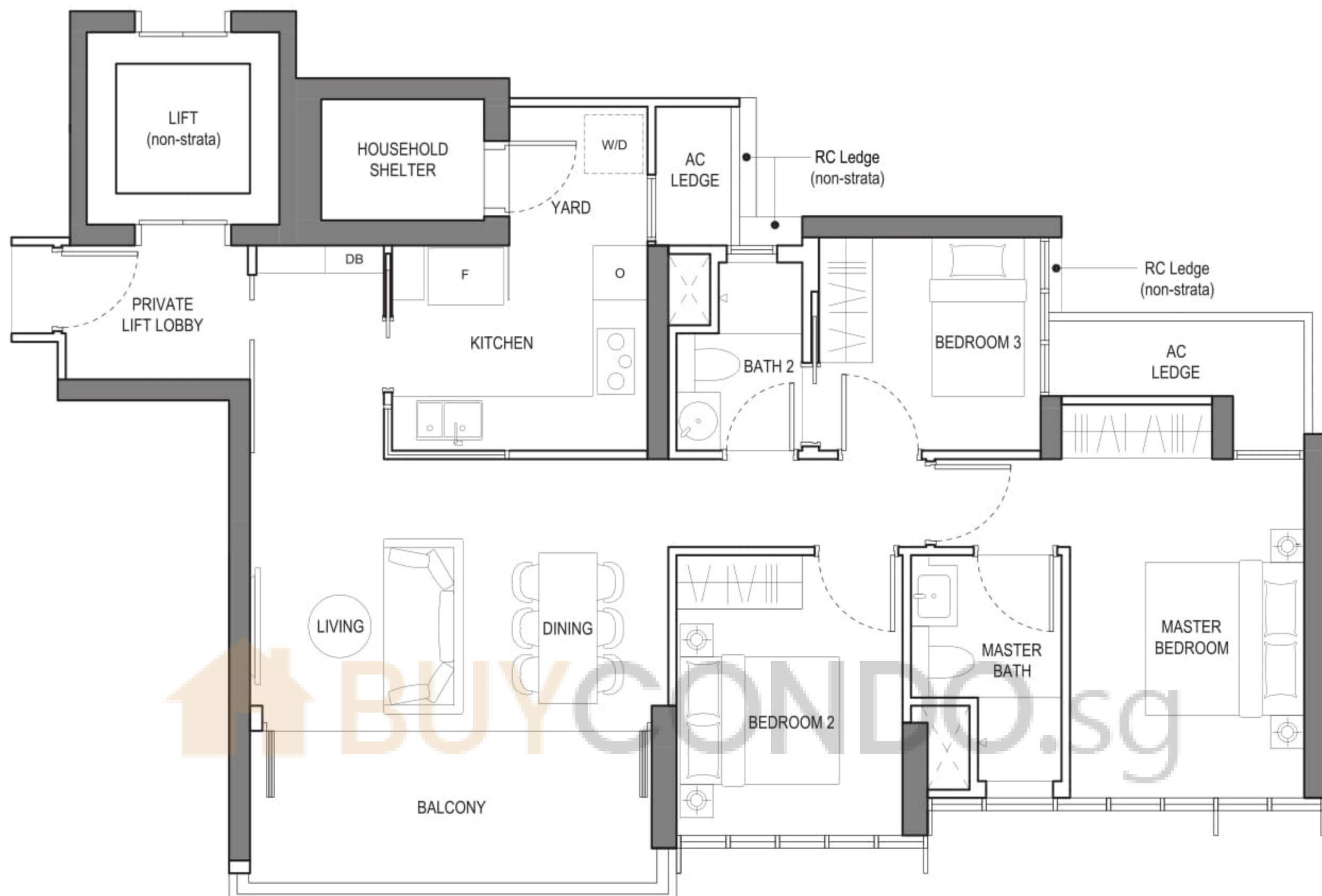

(114A) #02-03 to #03-03, #06-03 to #08-03, #14-03 to #19-03
 (114D) #03-15 to #04-15, #08-15 to #10-15, #19-15



(114A) #04-03 to #05-03, #09-03 to #13-03
 (114D) #02-15, #05-15 to #07-15, #12-15 to #18-15

LEGEND:

W/D	WASHER CUM DRYER	F	FRIDGE	O	OVEN
DB	DISTRIBUTION BOX		VOID SPACE (EXCLUDED FROM THE STRATA AREA)		AC LEDGE

NOTE:
 AREA INCLUDES A/C LEDGE AND BALCONY WHERE APPLICABLE. THE ABOVE PLANS AND ILLUSTRATIONS ARE SUBJECT TO CHANGE AS MAYBE REQUIRED OR APPROVED BY THE RELEVANT AUTHORITIES. ALL FLOOR AREAS ARE APPROXIMATE ONLY AND SUBJECT TO FINAL SURVEY. PLEASE REFER TO KEY PLAN FOR ORIENTATION. FOR AN ILLUSTRATION OF THE APPROVED BALCONY SCREEN, PLEASE REFER TO "BALCONY SCREEN" PAGE IN THIS BROCHURE.

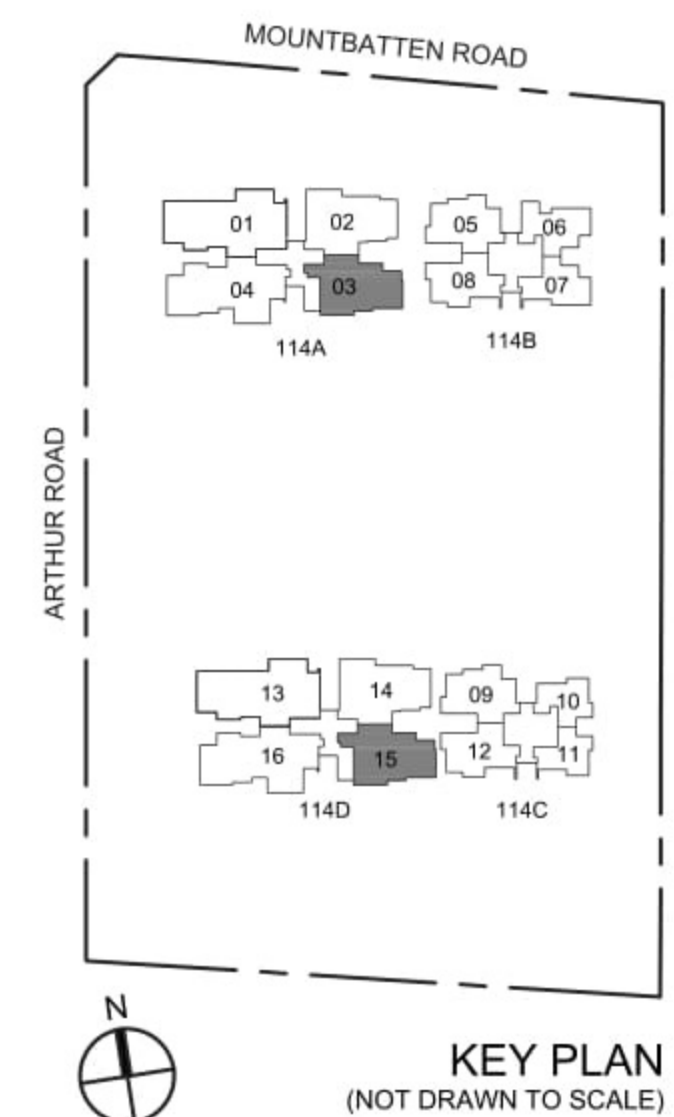

3 Bedroom

TYPE C2(p)

121 sqm / 1,302 sqft

(114D) #01-16

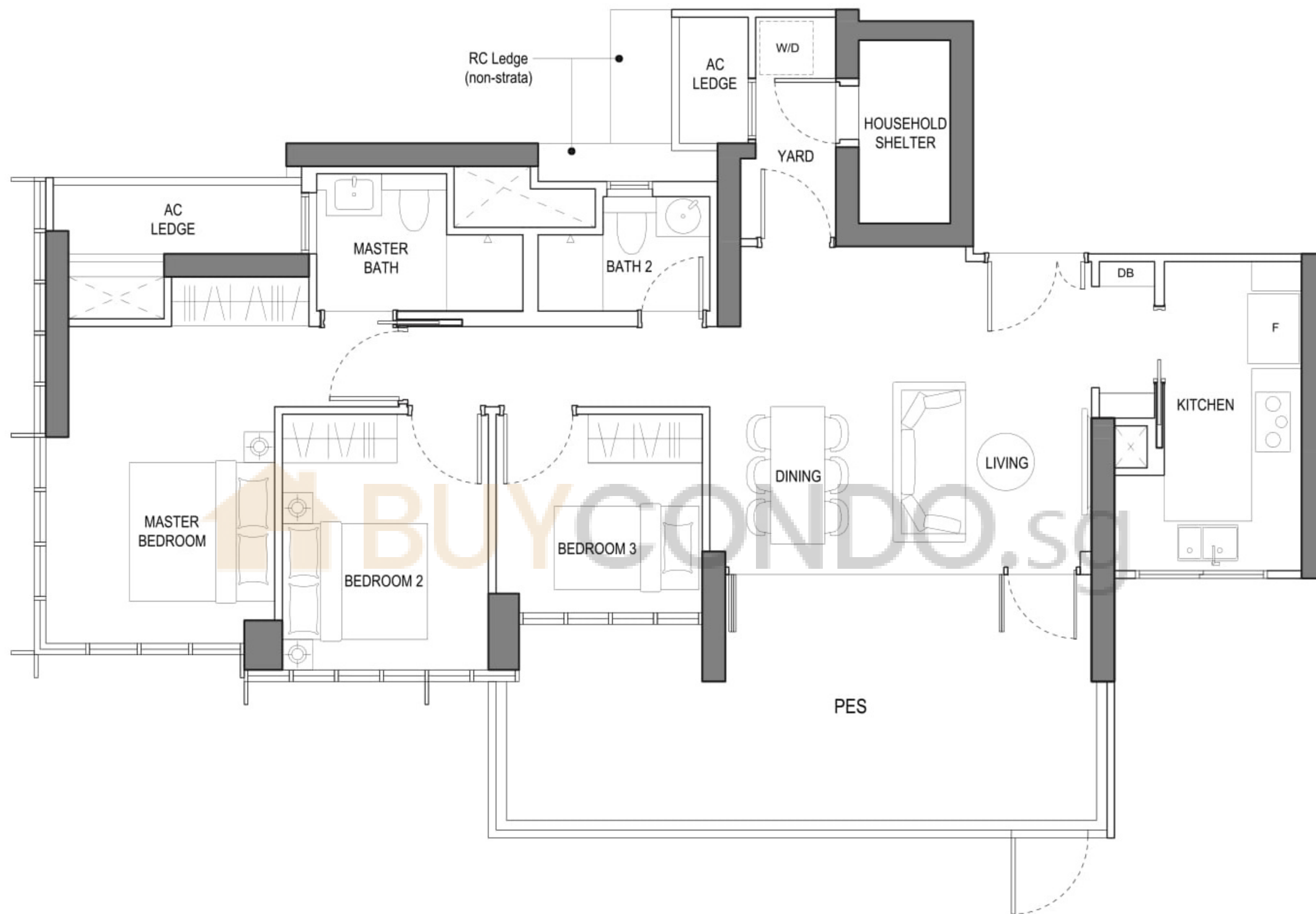

LEGEND:

- W/D
- F
- O
- DB
- VOID SPACE (EXCLUDED FROM THE STRATA AREA)
- AC LEDGE
- WASHER CUM DRYER
- FRIDGE
- OVEN (BELOW HOB)
- DISTRIBUTION BOX
- AC LEDGE
- AC LEDGE

NOTE:
 AREA INCLUDES A/C LEDGE AND BALCONY WHERE APPLICABLE. THE ABOVE PLANS AND ILLUSTRATIONS ARE SUBJECT TO CHANGE AS MAYBE REQUIRED OR APPROVED BY THE RELEVANT AUTHORITIES. ALL FLOOR AREAS ARE APPROXIMATE ONLY AND SUBJECT TO FINAL SURVEY. PLEASE REFER TO KEY PLAN FOR ORIENTATION. FOR AN ILLUSTRATION OF THE APPROVED BALCONY SCREEN, PLEASE REFER TO "BALCONY SCREEN" PAGE IN THIS BROCHURE.

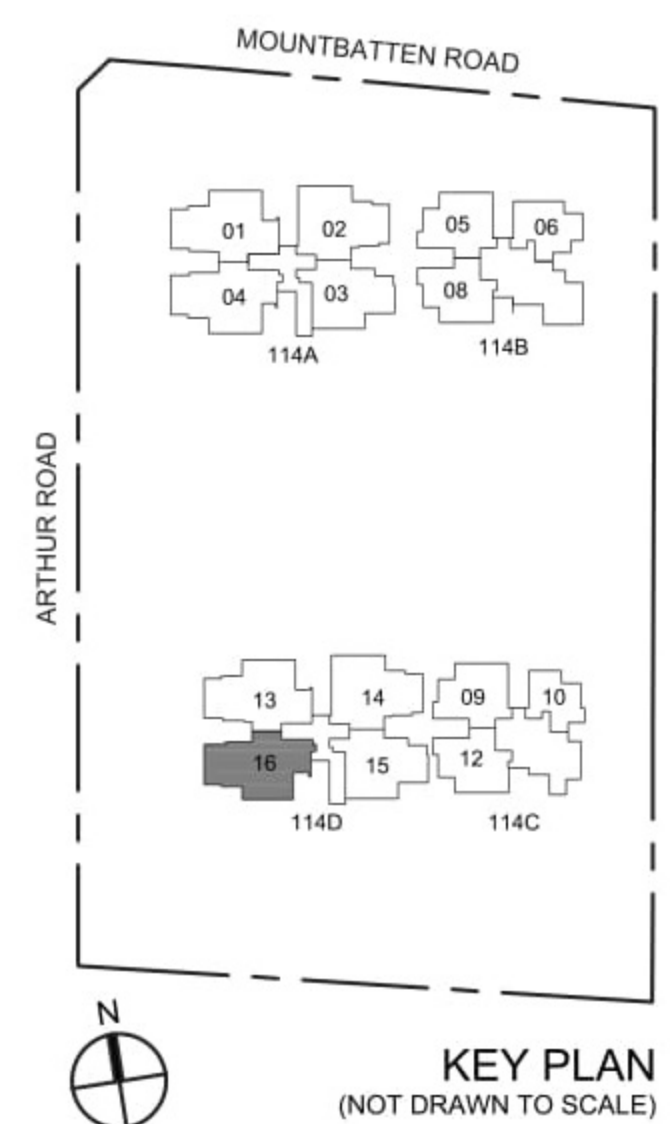

3 Bedroom

TYPE C2

112 sqm / 1,206 sqft

(114D) #02-16 to #10-16

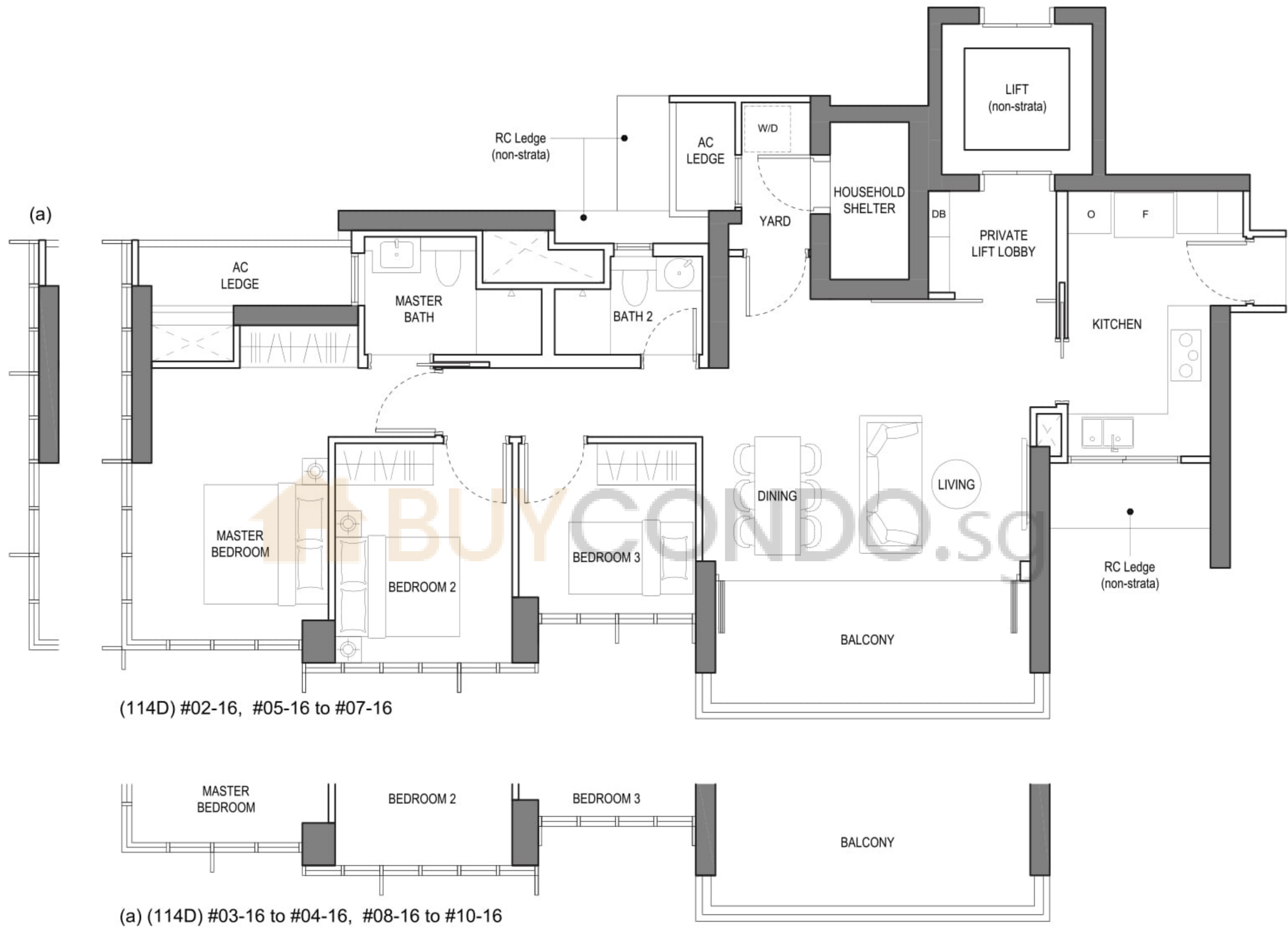

LEGEND:

W/D	WASHER CUM DRYER	F	FRIDGE	O	OVEN
DB	DISTRIBUTION BOX		VOID SPACE (EXCLUDED FROM THE STRATA AREA)		AC LEDGE

NOTE:
 AREA INCLUDES A/C LEDGE AND BALCONY WHERE APPLICABLE. THE ABOVE PLANS AND ILLUSTRATIONS ARE SUBJECT TO CHANGE AS MAYBE REQUIRED OR APPROVED BY THE RELEVANT AUTHORITIES. ALL FLOOR AREAS ARE APPROXIMATE ONLY AND SUBJECT TO FINAL SURVEY. PLEASE REFER TO KEY PLAN FOR ORIENTATION. FOR AN ILLUSTRATION OF THE APPROVED BALCONY SCREEN, PLEASE REFER TO "BALCONY SCREEN" PAGE IN THIS BROCHURE.

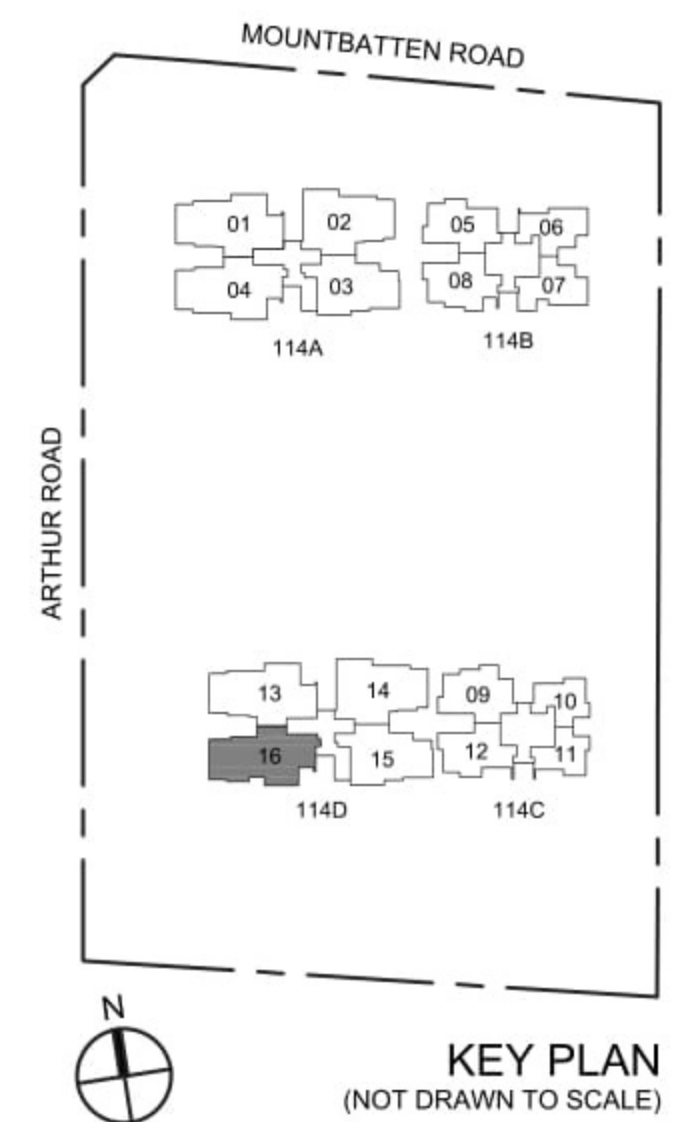

3 Bedroom Deluxe

TYPE C3(p)

133 sqm / 1,432 sqft

(114A) #01-02

(114D) #01-14

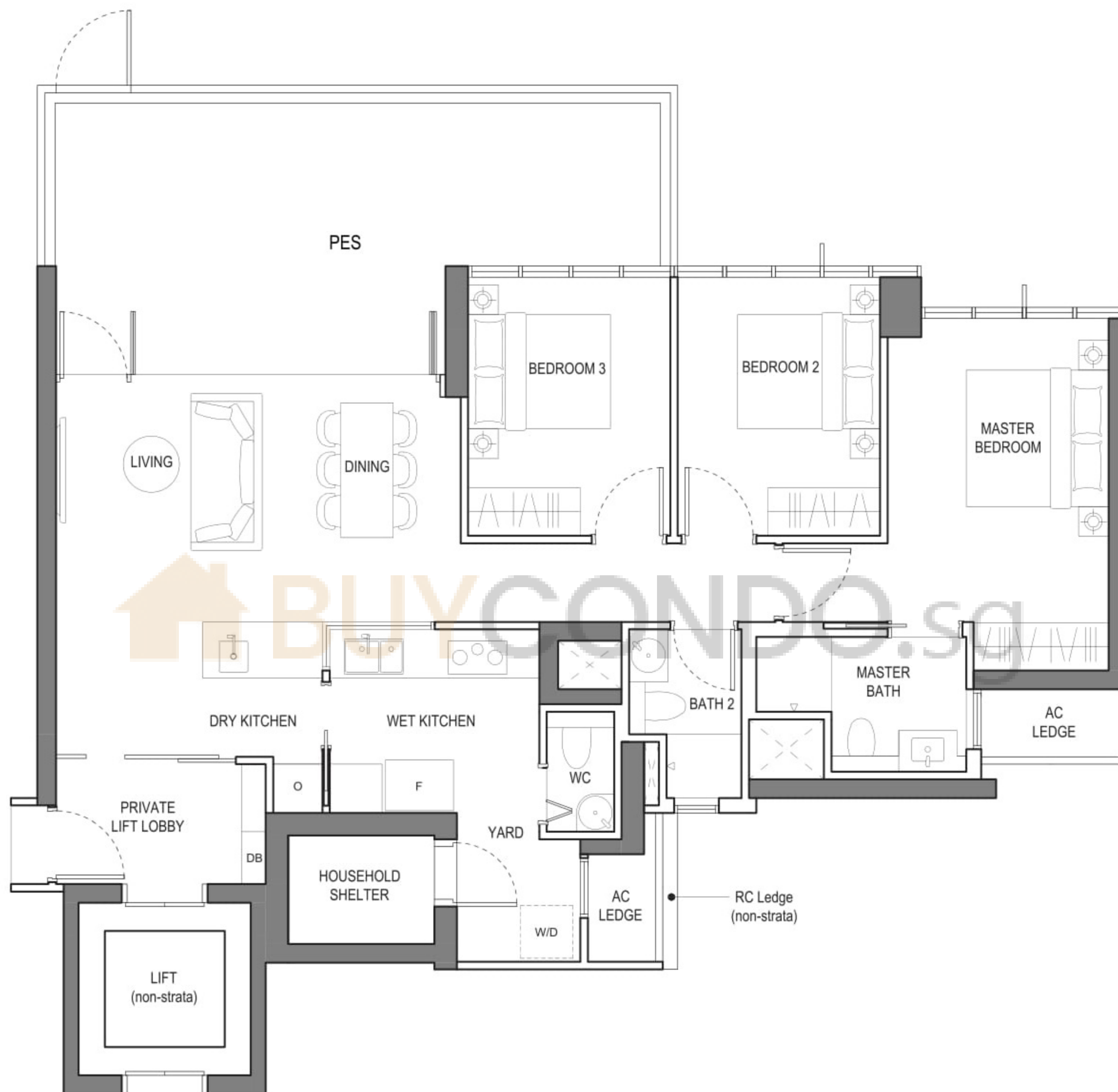

LEGEND:

 W/D	WASHER CUM DRYER	 F	FRIDGE	 O	OVEN
 DB	DISTRIBUTION BOX		VOID SPACE (EXCLUDED FROM THE STRATA AREA)	 AC LEDGE	AC LEDGE

NOTE:
 AREA INCLUDES A/C LEDGE AND BALCONY WHERE APPLICABLE. THE ABOVE PLANS AND ILLUSTRATIONS ARE SUBJECT TO CHANGE AS MAYBE REQUIRED OR APPROVED BY THE RELEVANT AUTHORITIES. ALL FLOOR AREAS ARE APPROXIMATE ONLY AND SUBJECT TO FINAL SURVEY. PLEASE REFER TO KEY PLAN FOR ORIENTATION. FOR AN ILLUSTRATION OF THE APPROVED BALCONY SCREEN, PLEASE REFER TO "BALCONY SCREEN" PAGE IN THIS BROCHURE.

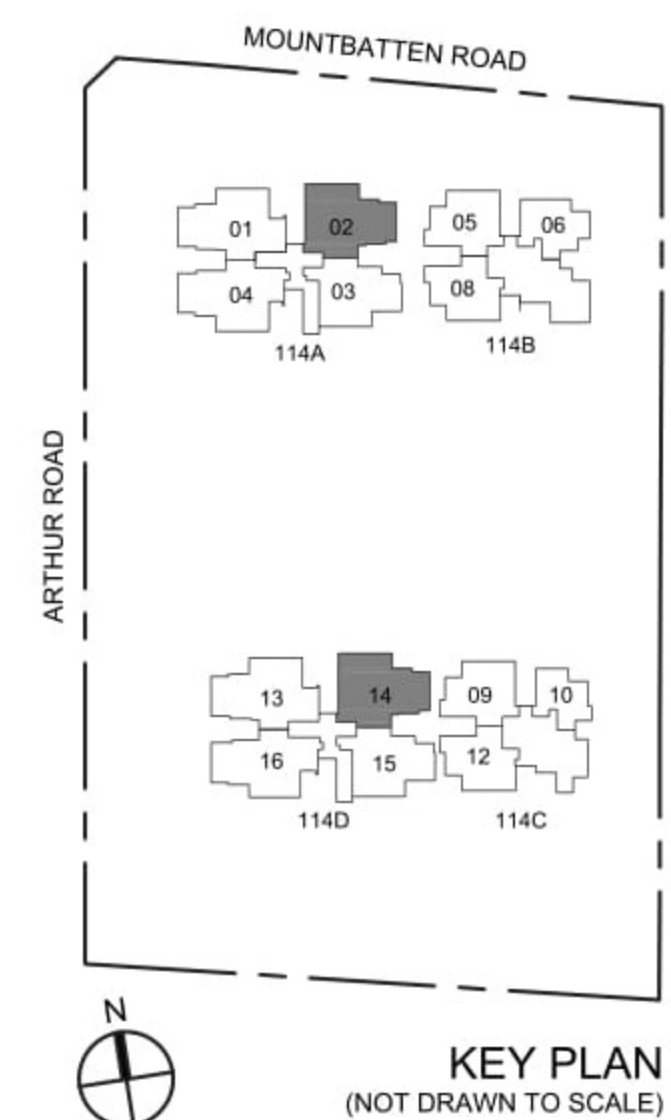

3 Bedroom Deluxe

TYPE C3

118 sqm / 1,270 sqft

(114A) #02-02 to #19-02

(114D) #02-14 to #10-14, #12-14 to #19-14

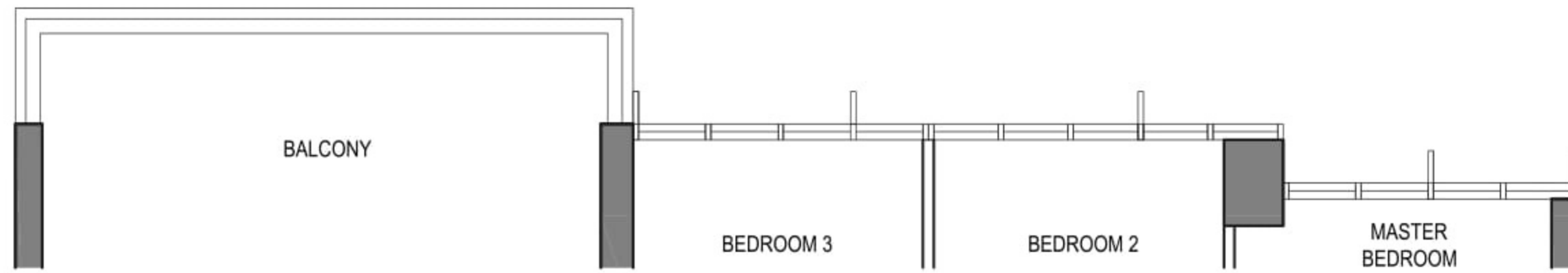

(114A) #04-02 to #05-02, #09-02 to #13-02

(114D) #02-14, #05-14 to #07-14, #12-14 to #18-14

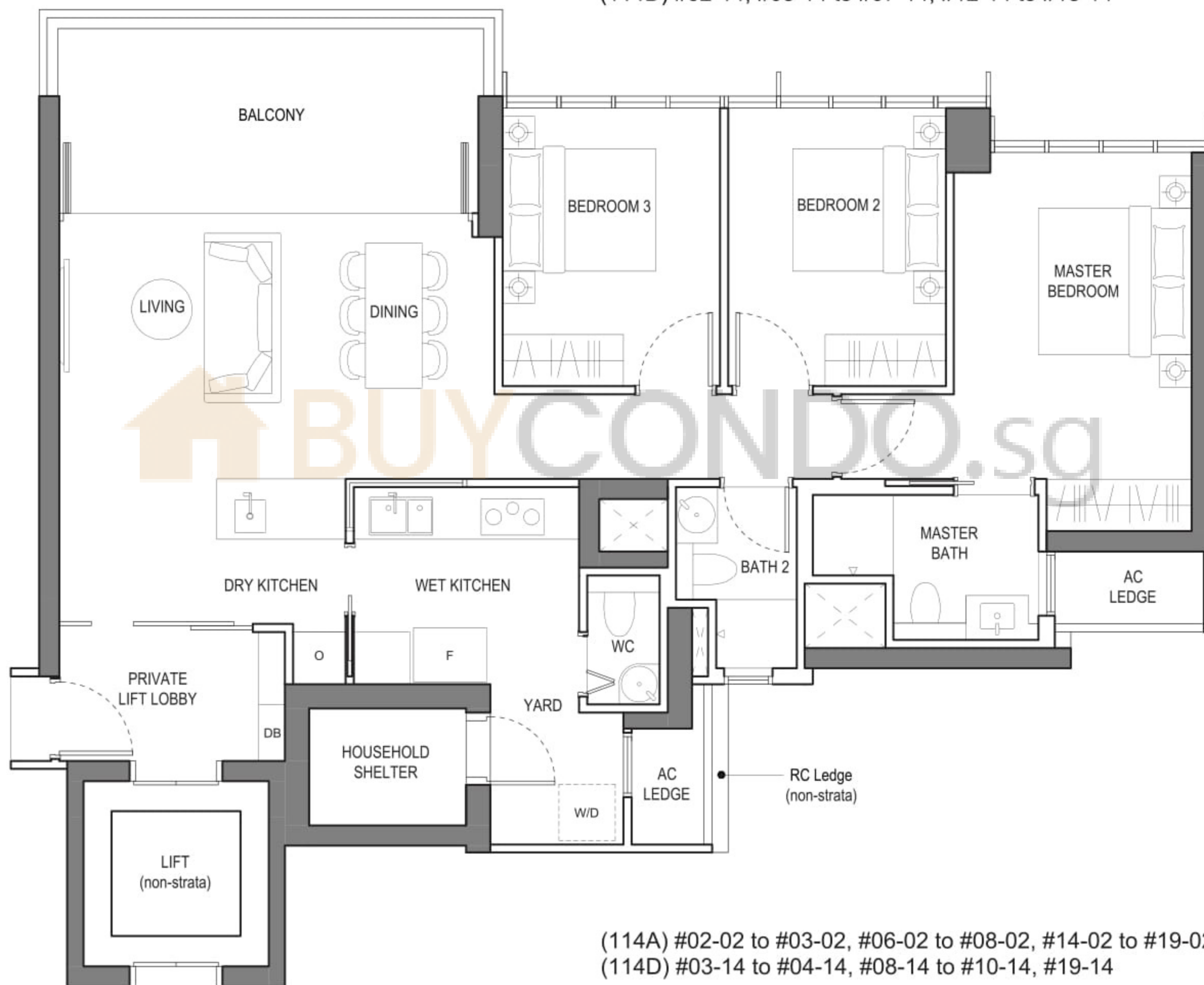

(114A) #02-02 to #03-02, #06-02 to #08-02, #14-02 to #19-02

(114D) #03-14 to #04-14, #08-14 to #10-14, #19-14

LEGEND:

W/D	WASHER CUM DRYER	F	FRIDGE	O	OVEN
DB	DISTRIBUTION BOX		VOID SPACE (EXCLUDED FROM THE STRATA AREA)		AC LEDGE

NOTE:
 AREA INCLUDES A/C LEDGE AND BALCONY WHERE APPLICABLE. THE ABOVE PLANS AND ILLUSTRATIONS ARE SUBJECT TO CHANGE AS MAYBE REQUIRED OR APPROVED BY THE RELEVANT AUTHORITIES. ALL FLOOR AREAS ARE APPROXIMATE ONLY AND SUBJECT TO FINAL SURVEY. PLEASE REFER TO KEY PLAN FOR ORIENTATION. FOR AN ILLUSTRATION OF THE APPROVED BALCONY SCREEN, PLEASE REFER TO "BALCONY SCREEN" PAGE IN THIS BROCHURE.

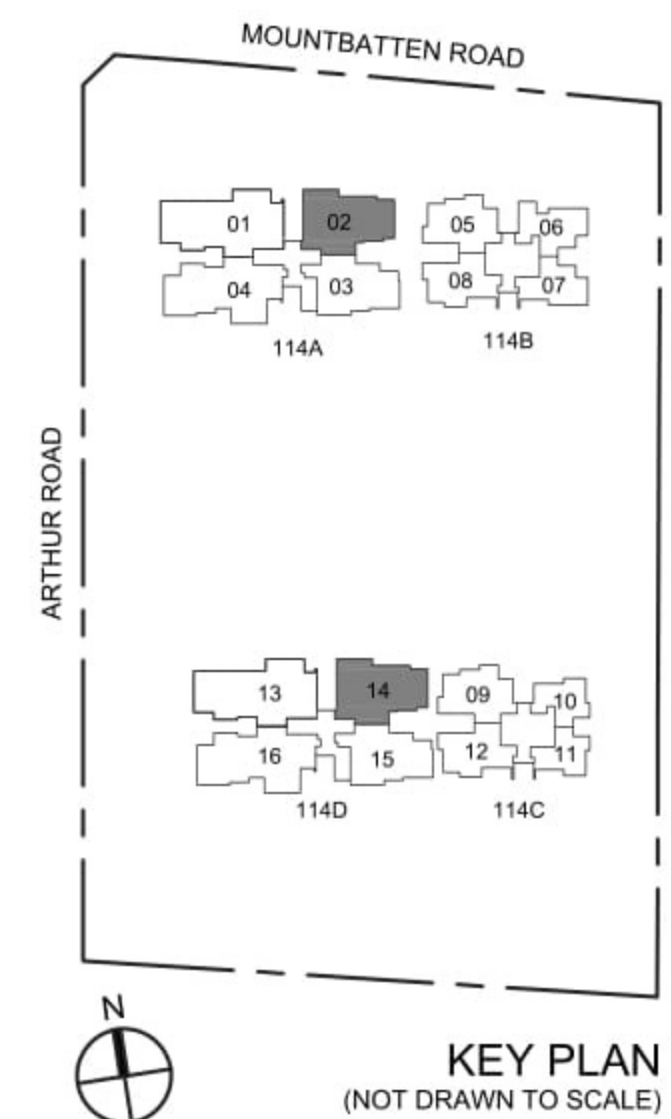

3 Bedroom Deluxe

TYPE C4(p)

129 sqm / 1,388 sqft

(114A) #01-04

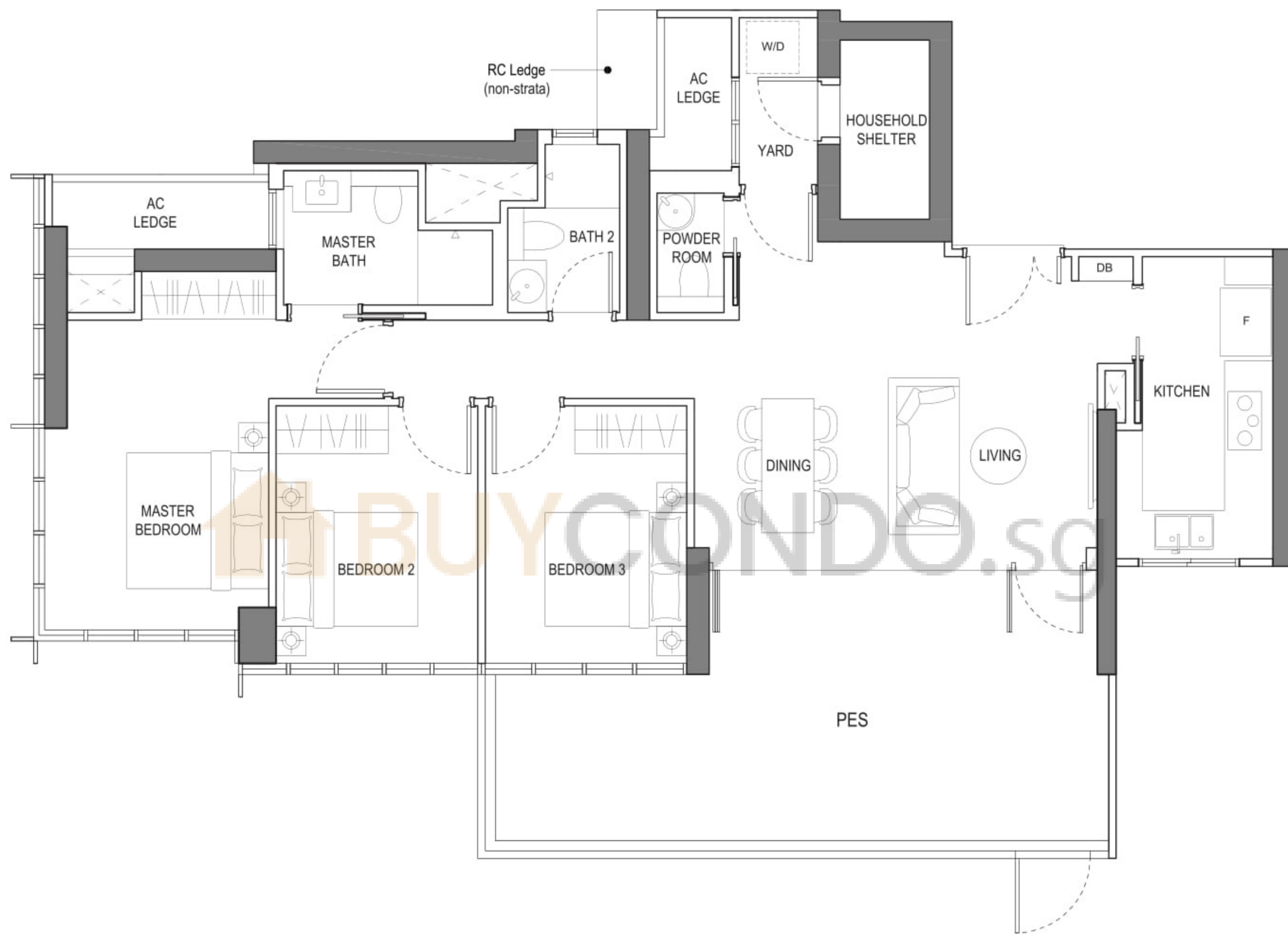

LEGEND:

- W/D WASHER CUM DRYER
- F FRIDGE
- O OVEN (BELOW HOB)
- DB DISTRIBUTION BOX
- VOID SPACE (EXCLUDED FROM THE STRATA AREA)
- AC LEDGE AC LEDGE

NOTE:
 AREA INCLUDES A/C LEDGE AND BALCONY WHERE APPLICABLE. THE ABOVE PLANS AND ILLUSTRATIONS ARE SUBJECT TO CHANGE AS MAYBE REQUIRED OR APPROVED BY THE RELEVANT AUTHORITIES. ALL FLOOR AREAS ARE APPROXIMATE ONLY AND SUBJECT TO FINAL SURVEY. PLEASE REFER TO KEY PLAN FOR ORIENTATION. FOR AN ILLUSTRATION OF THE APPROVED BALCONY SCREEN, PLEASE REFER TO "BALCONY SCREEN" PAGE IN THIS BROCHURE.

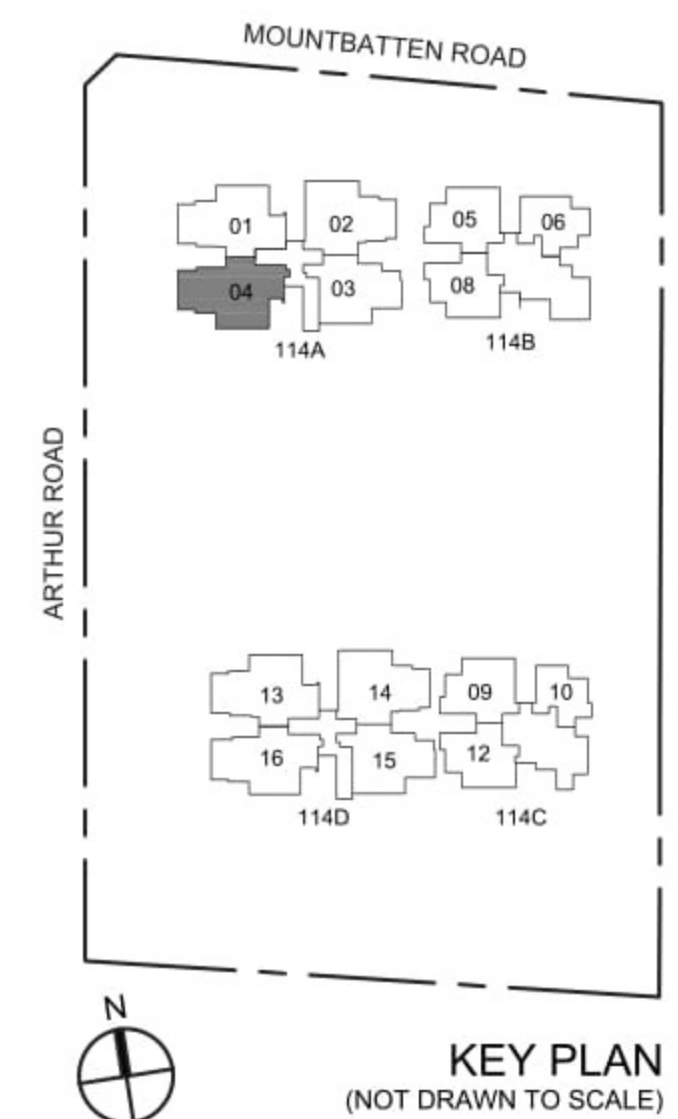

3 Bedroom Deluxe

TYPE C4

121 sqm / 1,302 sqft

(114A) #02-04 to #12-04

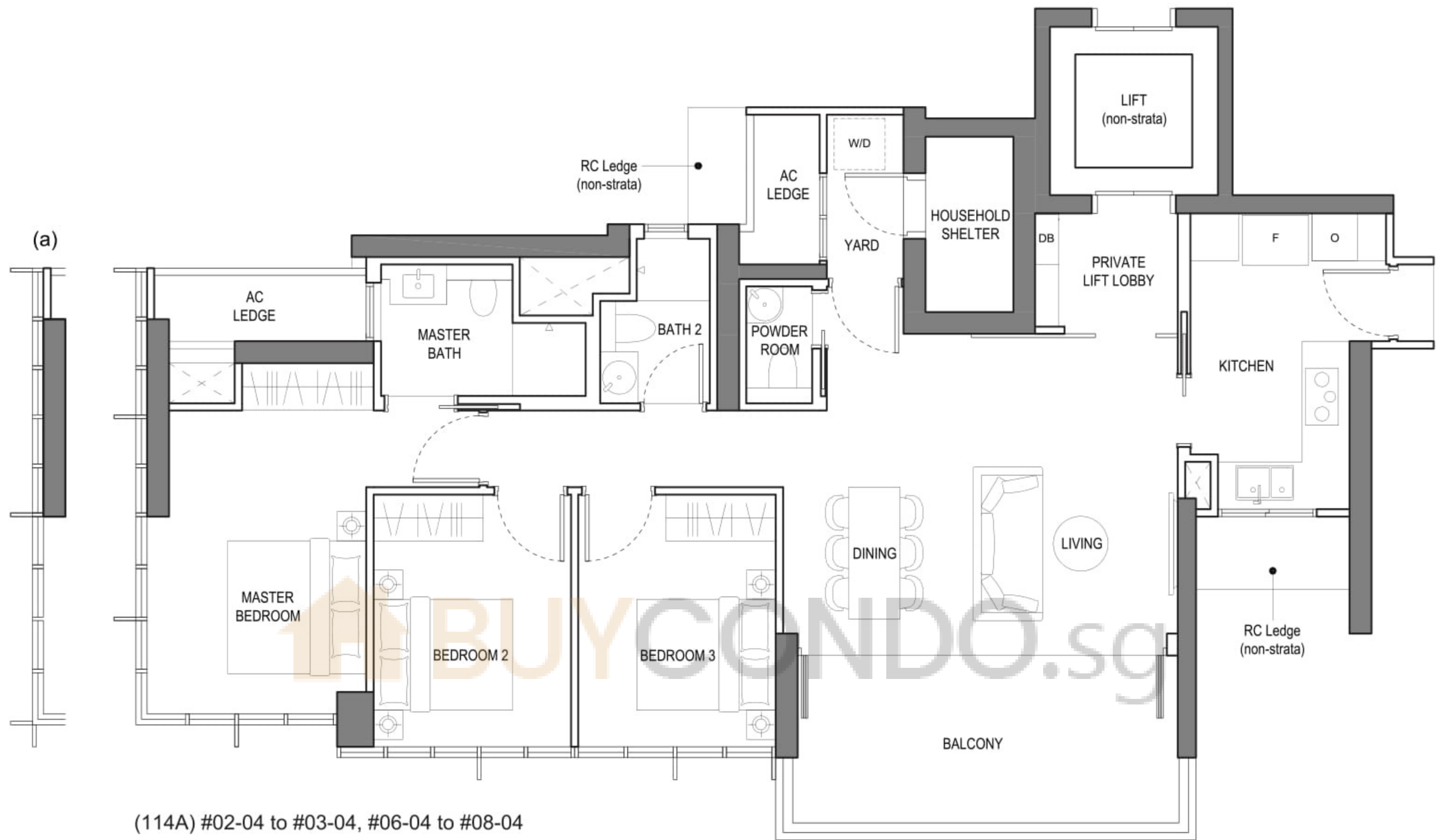

(114A) #02-04 to #03-04, #06-04 to #08-04

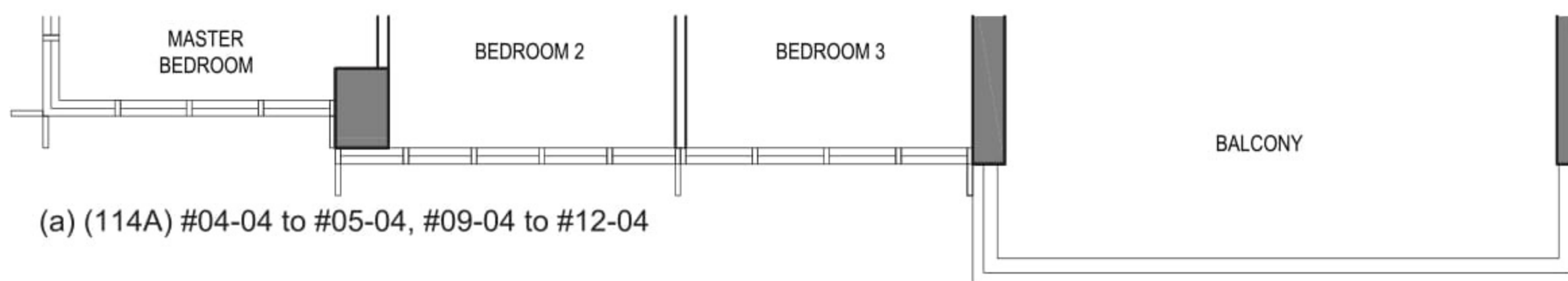

(a) (114A) #04-04 to #05-04, #09-04 to #12-04

LEGEND:

W/D	WASHER CUM DRYER	F	FRIDGE	O	OVEN
DB	DISTRIBUTION BOX		VOID SPACE (EXCLUDED FROM THE STRATA AREA)		AC LEDGE

NOTE:
 AREA INCLUDES A/C LEDGE AND BALCONY WHERE APPLICABLE. THE ABOVE PLANS AND ILLUSTRATIONS ARE SUBJECT TO CHANGE AS MAYBE REQUIRED OR APPROVED BY THE RELEVANT AUTHORITIES. ALL FLOOR AREAS ARE APPROXIMATE ONLY AND SUBJECT TO FINAL SURVEY. PLEASE REFER TO KEY PLAN FOR ORIENTATION. FOR AN ILLUSTRATION OF THE APPROVED BALCONY SCREEN, PLEASE REFER TO "BALCONY SCREEN" PAGE IN THIS BROCHURE.

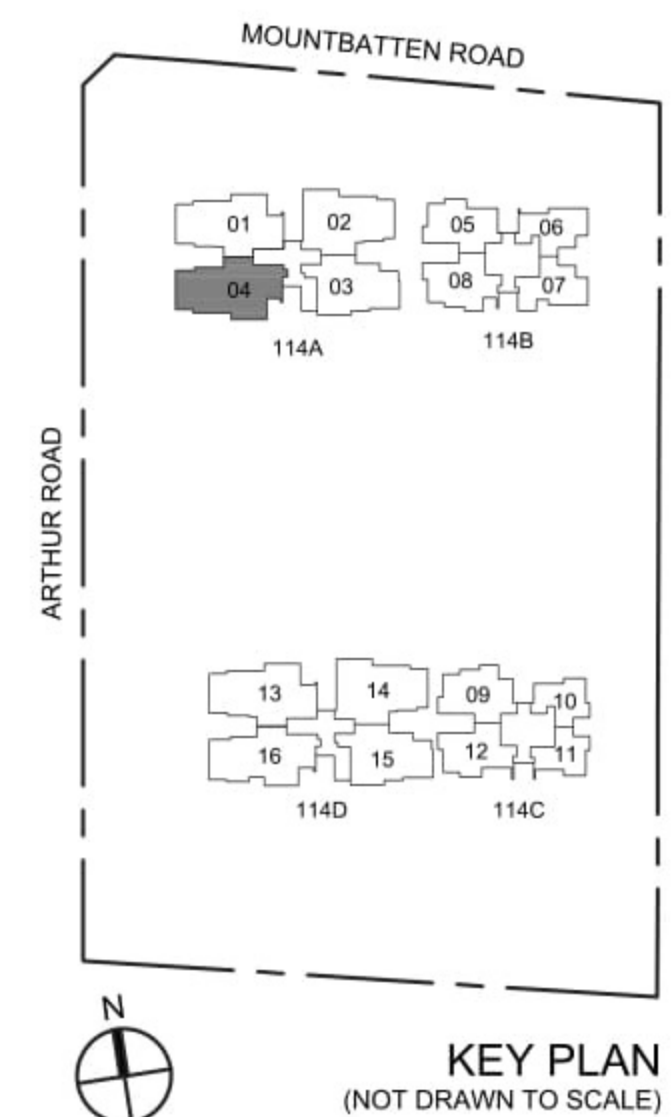

3 Bedroom Deluxe

TYPE C5(p)

135 sqm / 1,453 sqft

(114A) #01-01
(114D) #01-13



LEGEND:

W/D	WASHER CUM DRYER	F	FRIDGE	O	OVEN
DB	DISTRIBUTION BOX		VOID SPACE (EXCLUDED FROM THE STRATA AREA)		AC LEDGE

NOTE:
AREA INCLUDES A/C LEDGE AND BALCONY WHERE APPLICABLE. THE ABOVE PLANS AND ILLUSTRATIONS ARE SUBJECT TO CHANGE AS MAYBE REQUIRED OR APPROVED BY THE RELEVANT AUTHORITIES. ALL FLOOR AREAS ARE APPROXIMATE ONLY AND SUBJECT TO FINAL SURVEY. PLEASE REFER TO KEY PLAN FOR ORIENTATION. FOR AN ILLUSTRATION OF THE APPROVED BALCONY SCREEN, PLEASE REFER TO "BALCONY SCREEN" PAGE IN THIS BROCHURE.

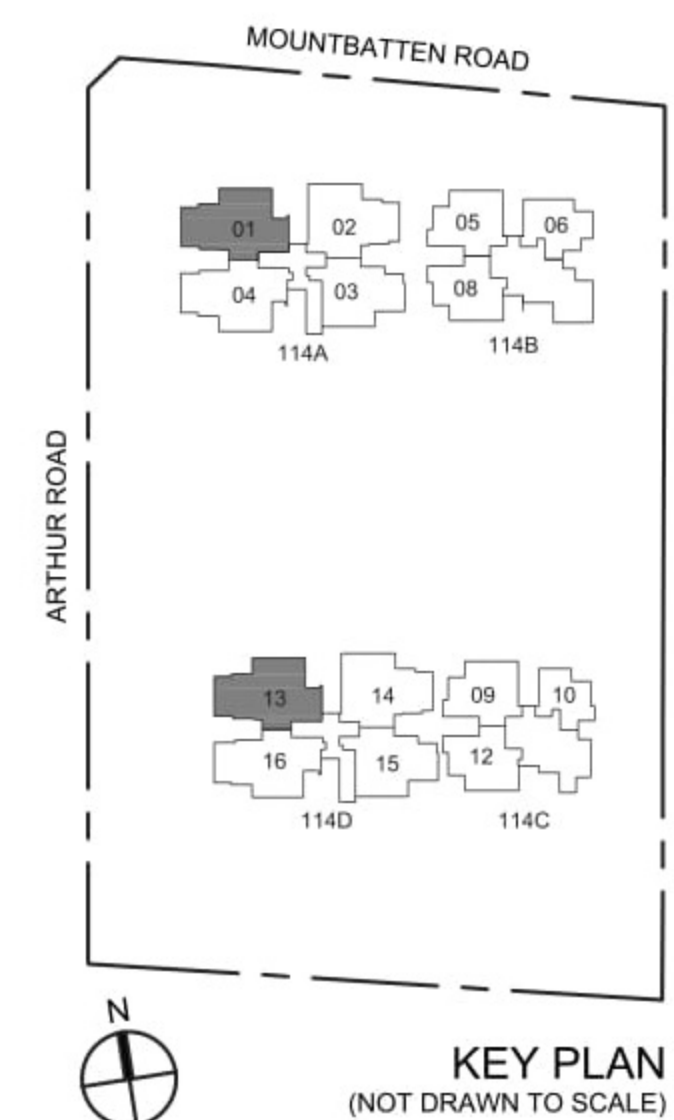

3 Bedroom Deluxe

TYPE C5

121 sqm / 1,302 sqft

(114A) #02-01 to #12-01
(114D) #02-13 to #10-13

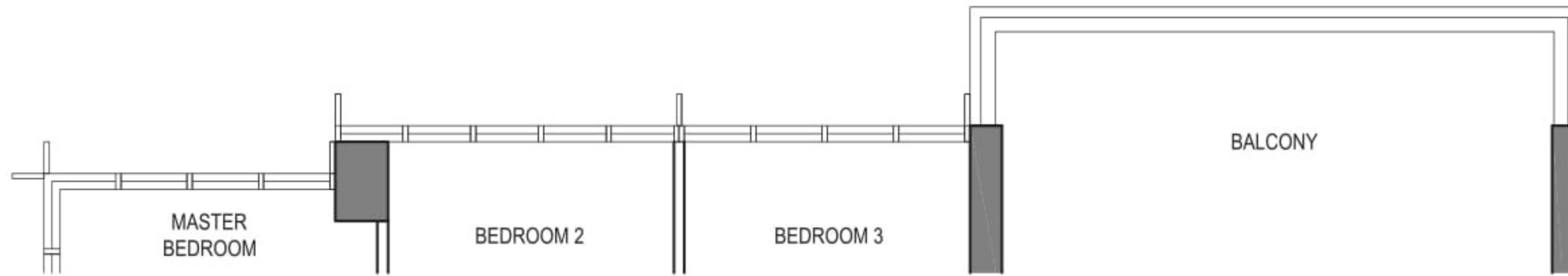

(a) (114A) #04-01 to #05-01, #09-01 to #12-01
(114D) #02-13, #05-13 to #07-13

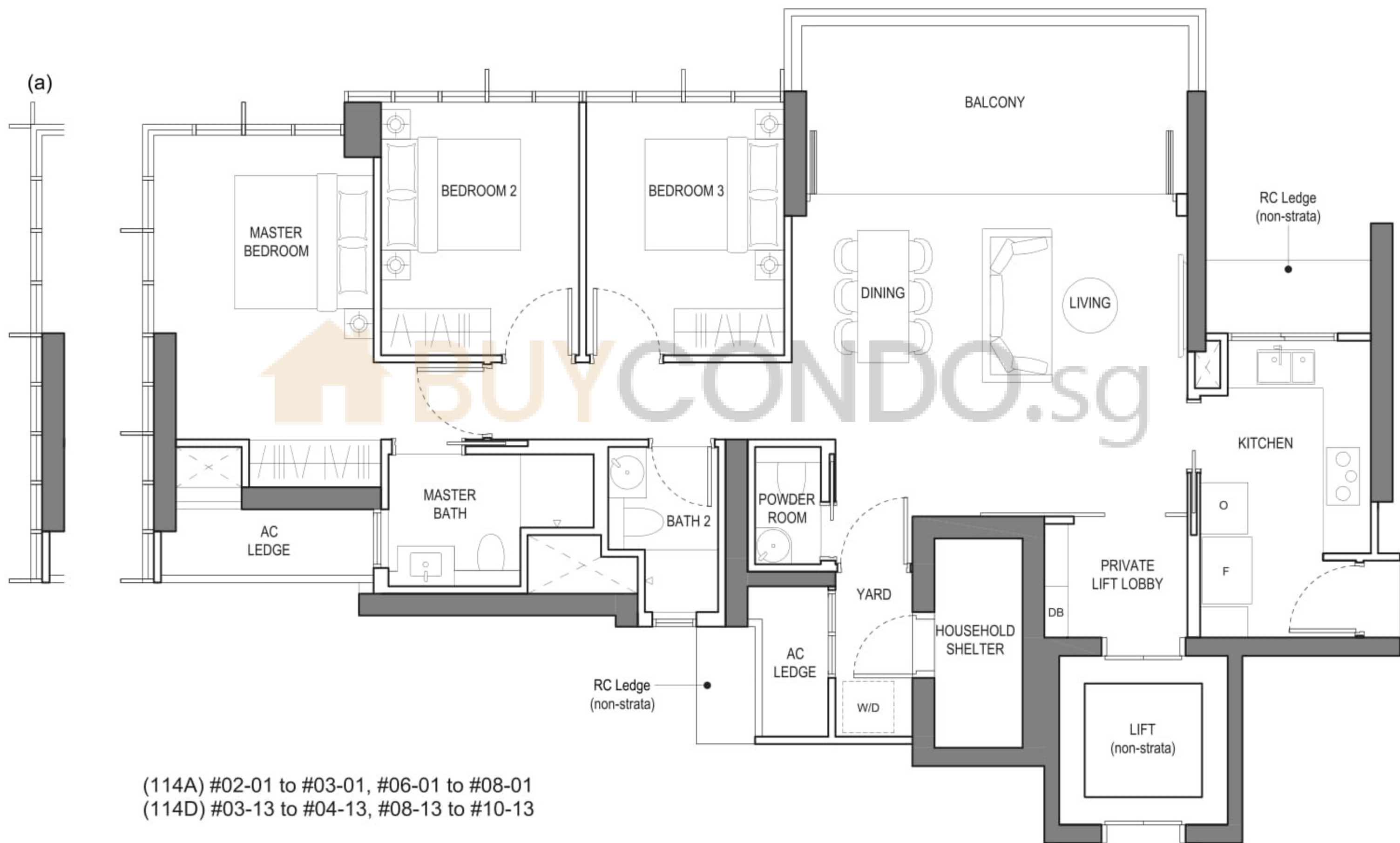

(114A) #02-01 to #03-01, #06-01 to #08-01
(114D) #03-13 to #04-13, #08-13 to #10-13

LEGEND:

W/D	WASHER CUM DRYER	F	FRIDGE	O	OVEN
DB	DISTRIBUTION BOX		VOID SPACE (EXCLUDED FROM THE STRATA AREA)		AC LEDGE

NOTE:
AREA INCLUDES A/C LEDGE AND BALCONY WHERE APPLICABLE. THE ABOVE PLANS AND ILLUSTRATIONS ARE SUBJECT TO CHANGE AS MAYBE REQUIRED OR APPROVED BY THE RELEVANT AUTHORITIES. ALL FLOOR AREAS ARE APPROXIMATE ONLY AND SUBJECT TO FINAL SURVEY. PLEASE REFER TO KEY PLAN FOR ORIENTATION. FOR AN ILLUSTRATION OF THE APPROVED BALCONY SCREEN, PLEASE REFER TO "BALCONY SCREEN" PAGE IN THIS BROCHURE.

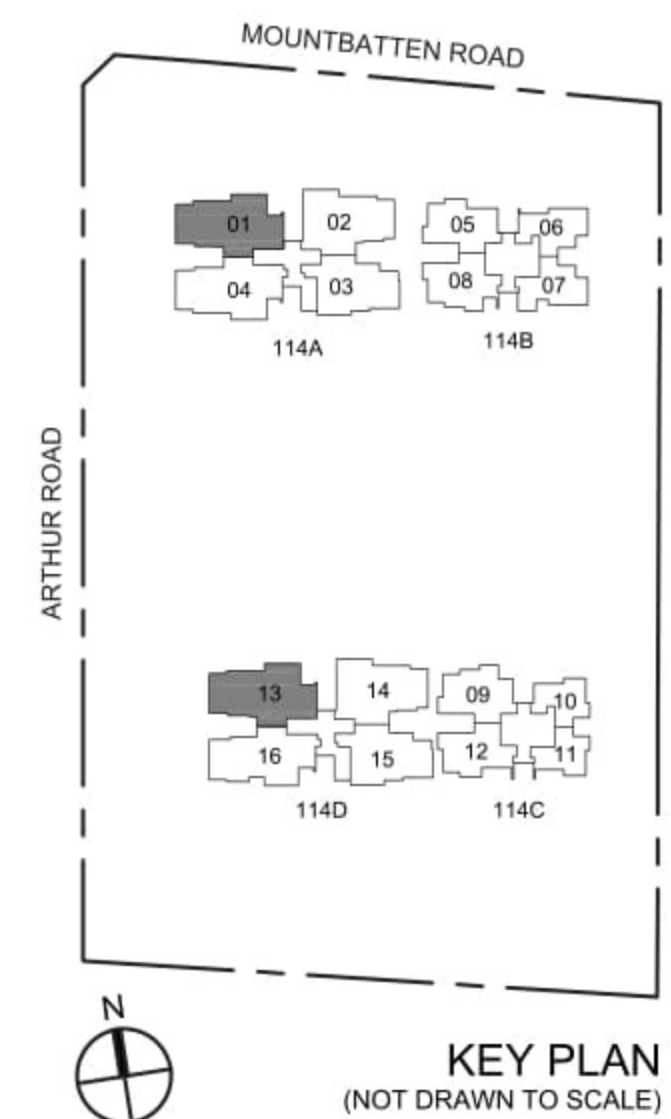

4 Bedroom

TYPE D1

141 sqm / 1,518 sqft

(114A) #14-04 to #19-04

(114D) #12-16 to #19-16

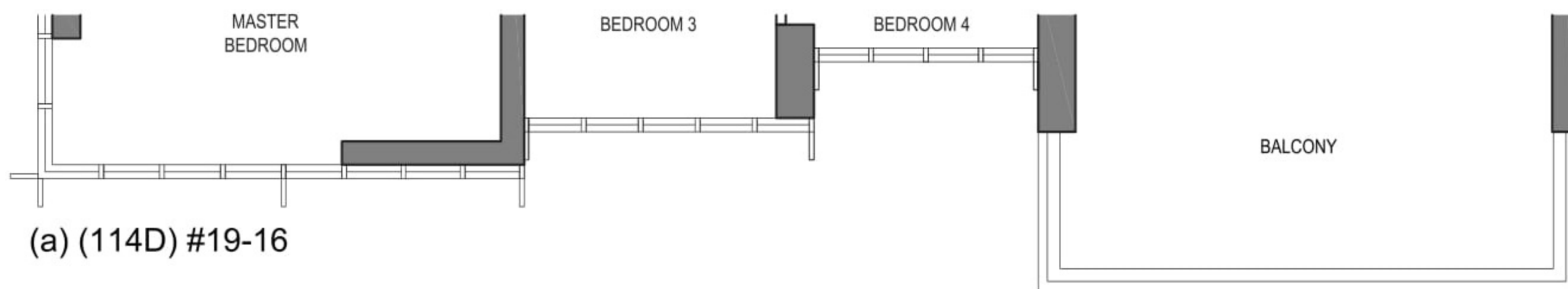
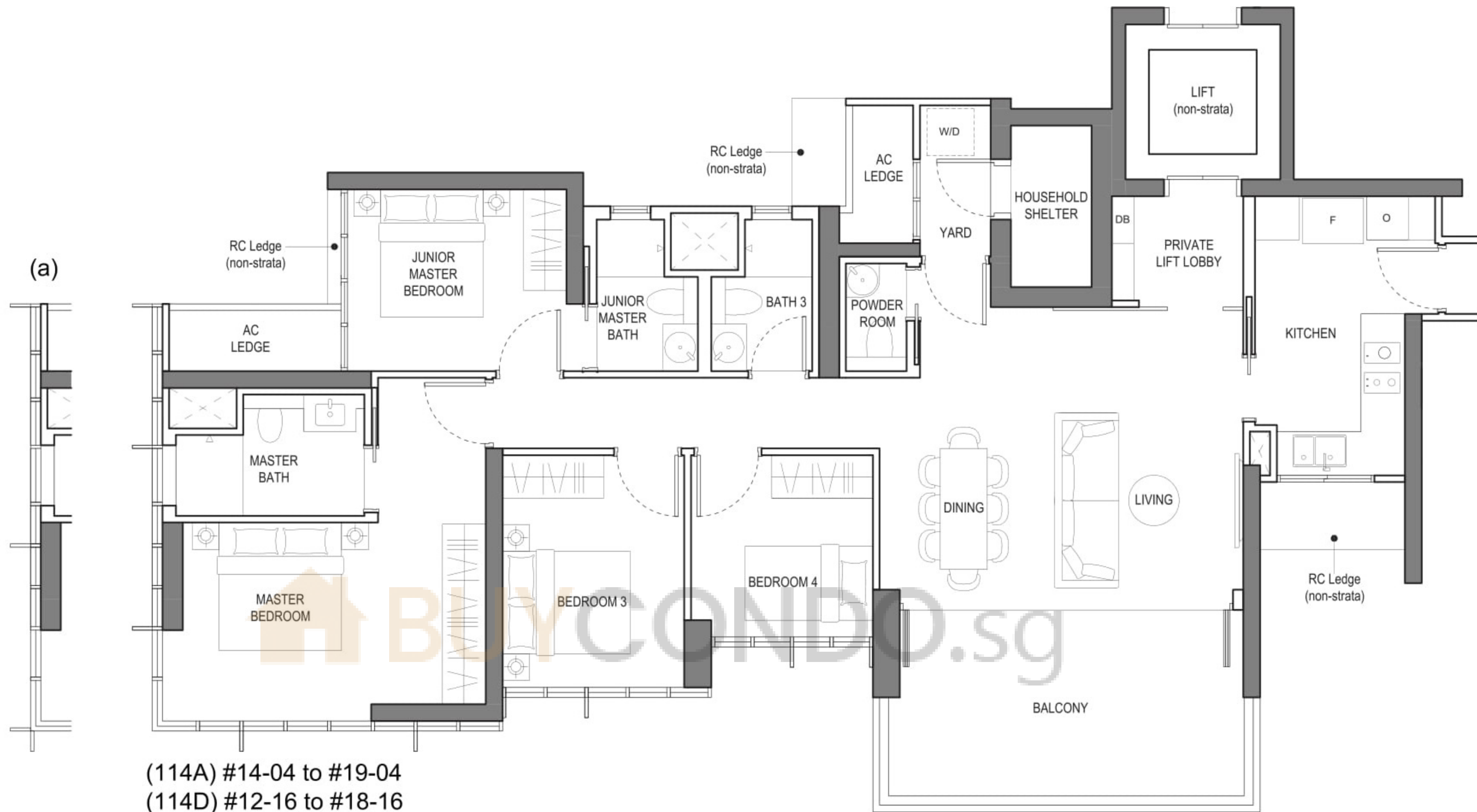

LEGEND:

W/D	WASHER CUM DRYER	F	FRIDGE	O	OVEN
DB	DISTRIBUTION BOX		VOID SPACE (EXCLUDED FROM THE STRATA AREA)	AC LEDGE	AC LEDGE

NOTE:
AREA INCLUDES A/C LEDGE AND BALCONY WHERE APPLICABLE. THE ABOVE PLANS AND ILLUSTRATIONS ARE SUBJECT TO CHANGE AS MAYBE REQUIRED OR APPROVED BY THE RELEVANT AUTHORITIES. ALL FLOOR AREAS ARE APPROXIMATE ONLY AND SUBJECT TO FINAL SURVEY. PLEASE REFER TO KEY PLAN FOR ORIENTATION. FOR AN ILLUSTRATION OF THE APPROVED BALCONY SCREEN, PLEASE REFER TO "BALCONY SCREEN" PAGE IN THIS BROCHURE.

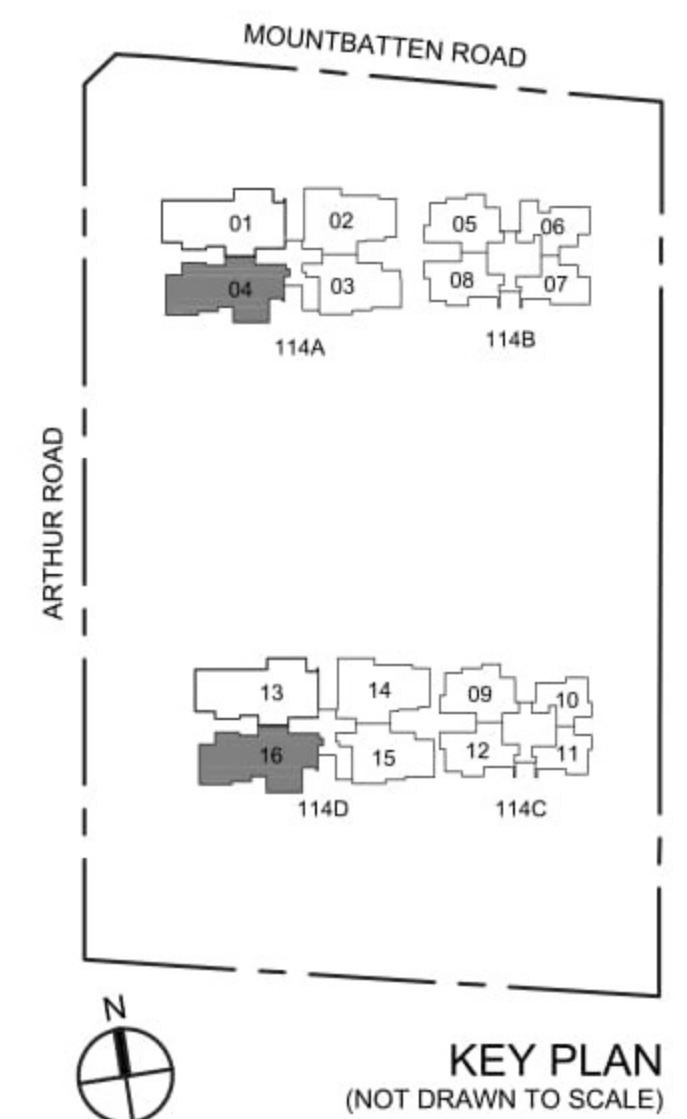

4 Bedroom Deluxe

TYPE D2

155 sqm / 1,668 sqft

(114A) #14-01 to #19-01
(114D) #12-13 to #19-13

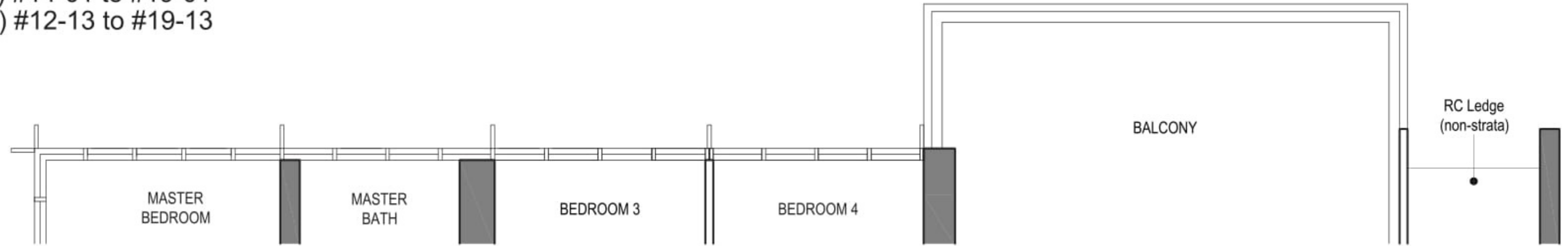

(a) (114D) #19-13

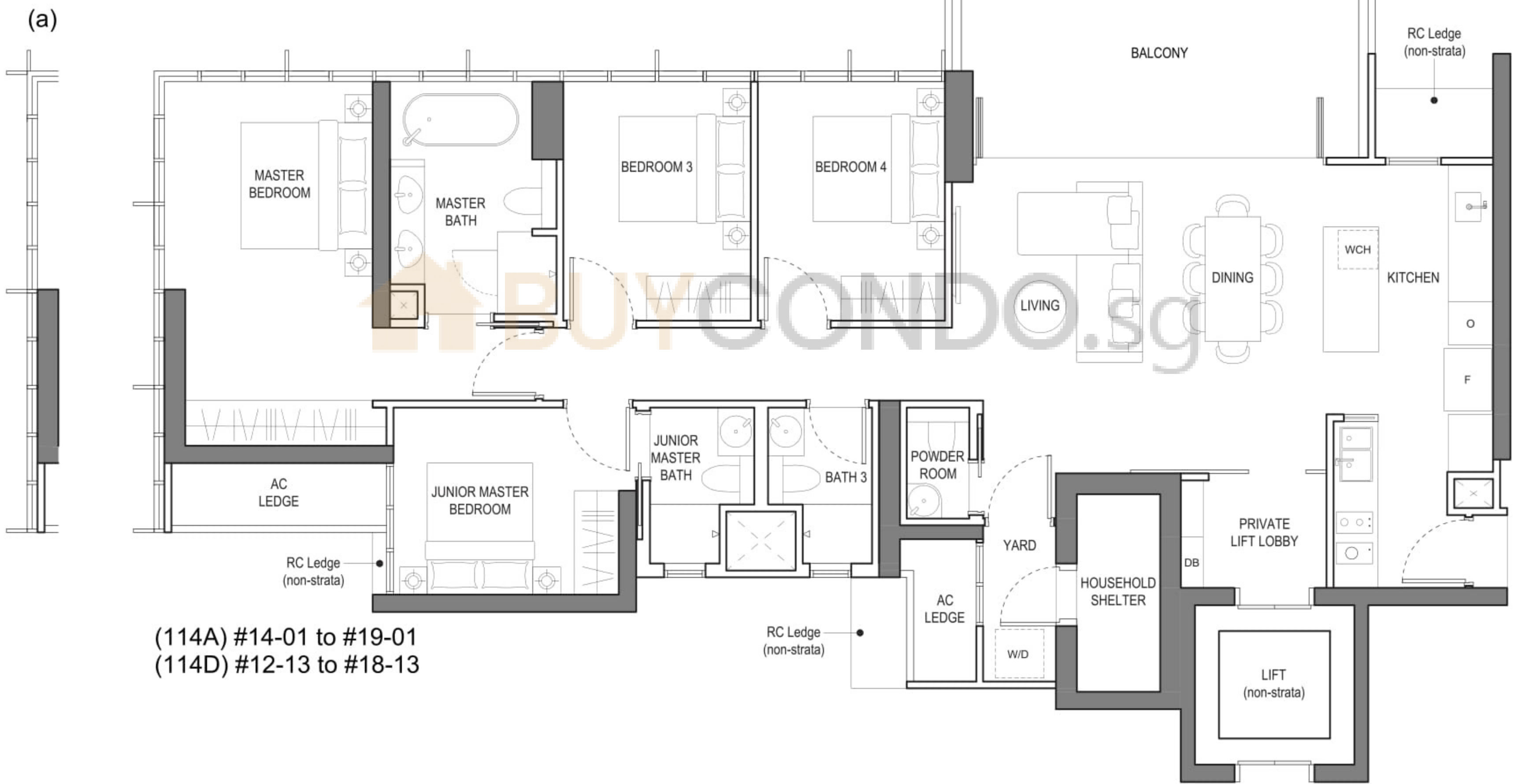

(114A) #14-01 to #19-01
(114D) #12-13 to #18-13

LEGEND:

W/D	WASHER CUM DRYER	F	FRIDGE	O	OVEN	WCH	WINE CHILLER
DB	DISTRIBUTION BOX		VOID SPACE (EXCLUDED FROM THE STRATA AREA)	AC LEDGE	AC LEDGE		

NOTE:
AREA INCLUDES A/C LEDGE AND BALCONY WHERE APPLICABLE. THE ABOVE PLANS AND ILLUSTRATIONS ARE SUBJECT TO CHANGE AS MAYBE REQUIRED OR APPROVED BY THE RELEVANT AUTHORITIES. ALL FLOOR AREAS ARE APPROXIMATE ONLY AND SUBJECT TO FINAL SURVEY. PLEASE REFER TO KEY PLAN FOR ORIENTATION. FOR AN ILLUSTRATION OF THE APPROVED BALCONY SCREEN, PLEASE REFER TO "BALCONY SCREEN" PAGE IN THIS BROCHURE.

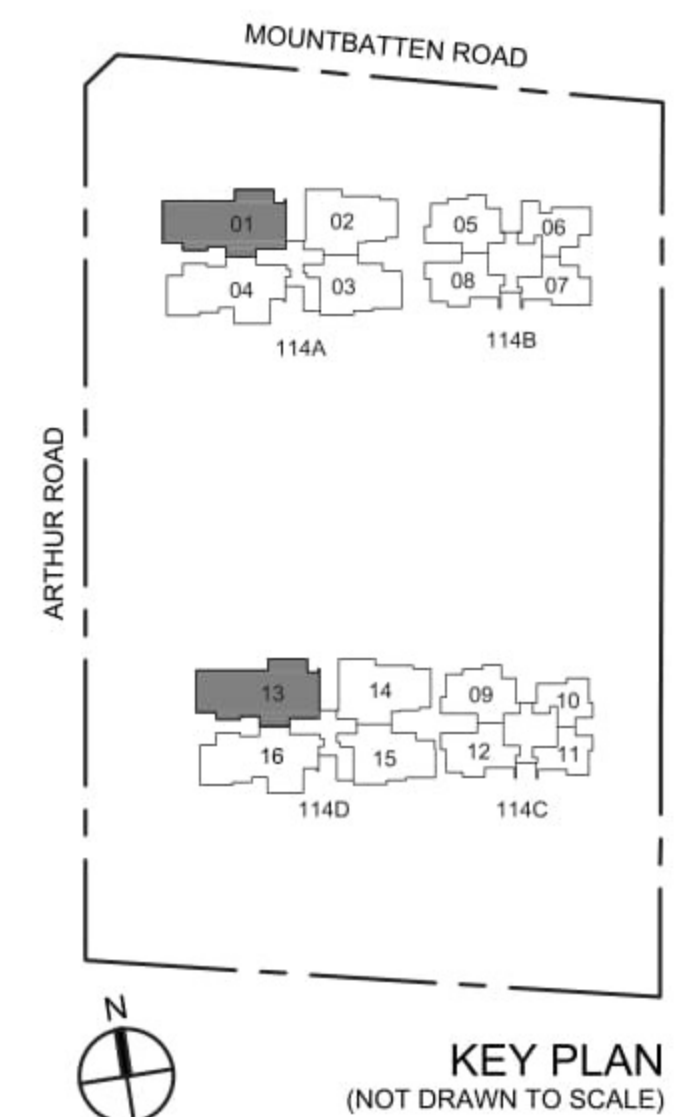

Approved Balcony Screens Design

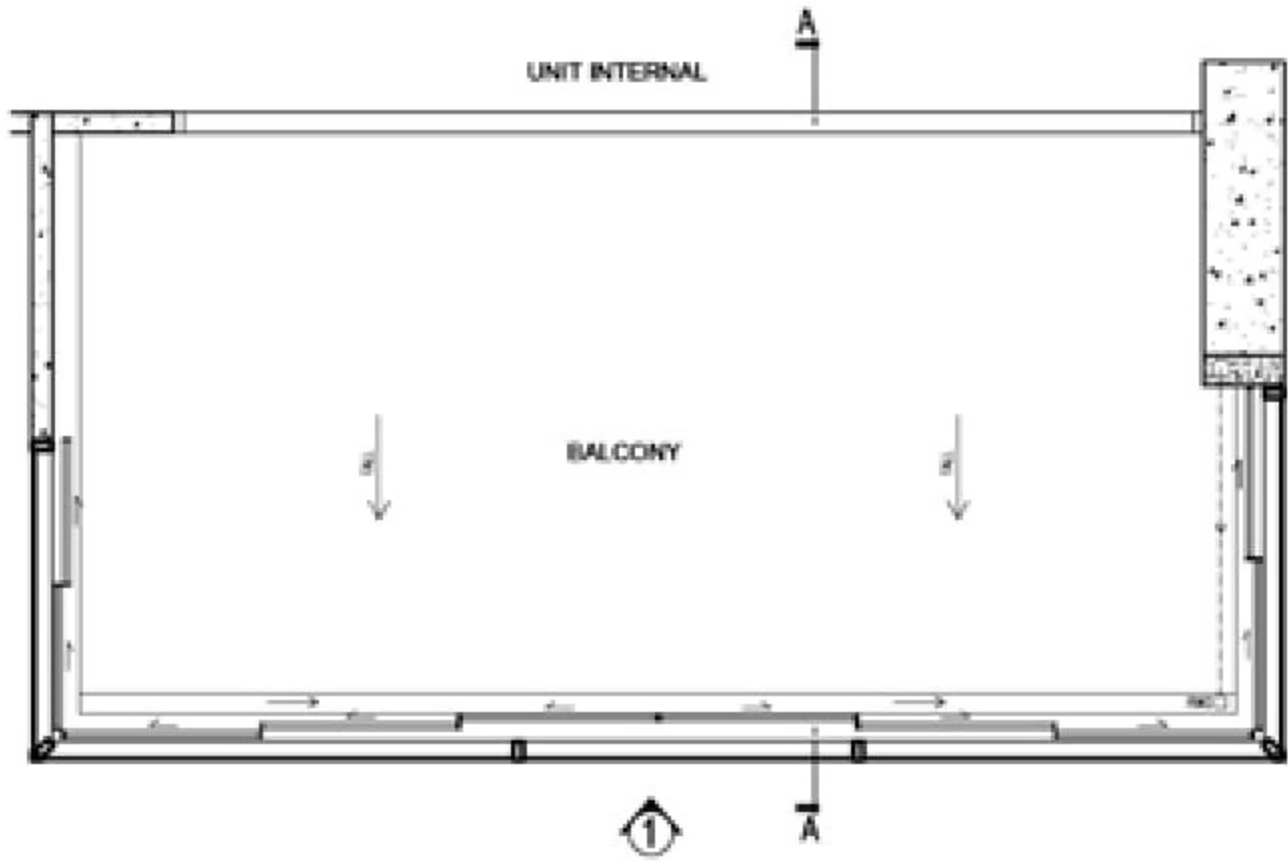

BALCONY SCREEN DETAILS - PART PLAN

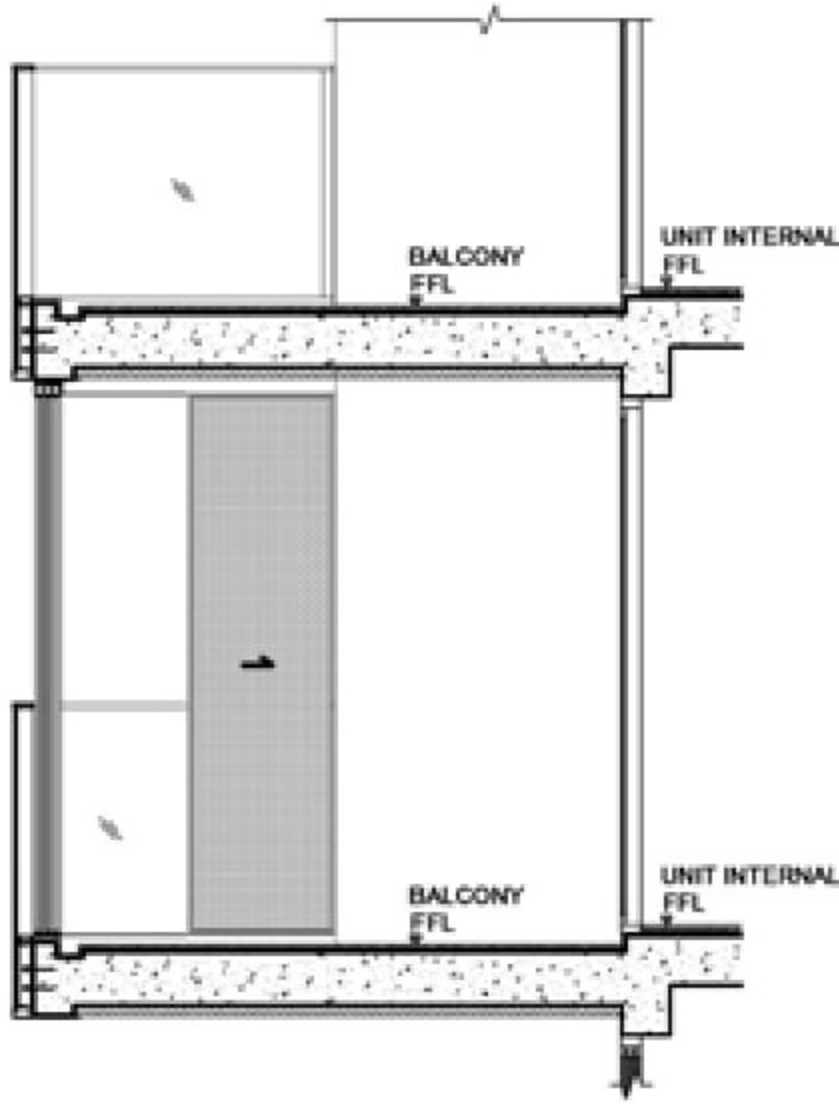

BALCONY DETAILS - SECTION A-A

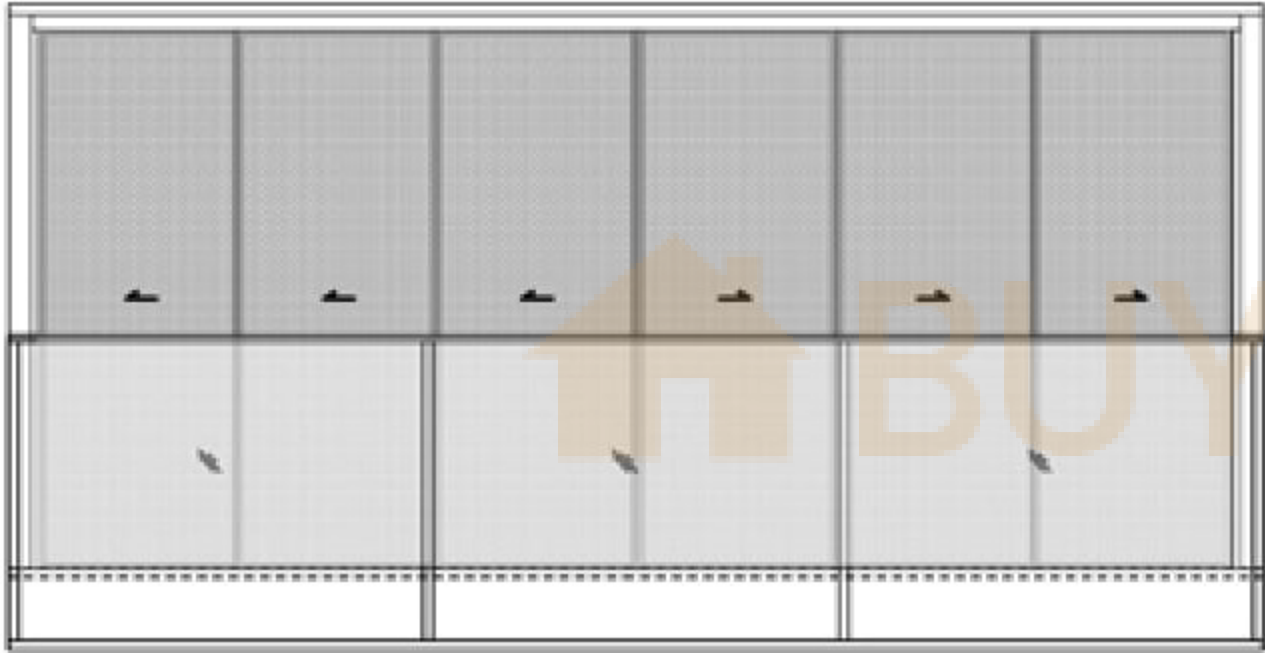

ELEVATION 1 (CLOSED SCREENS)

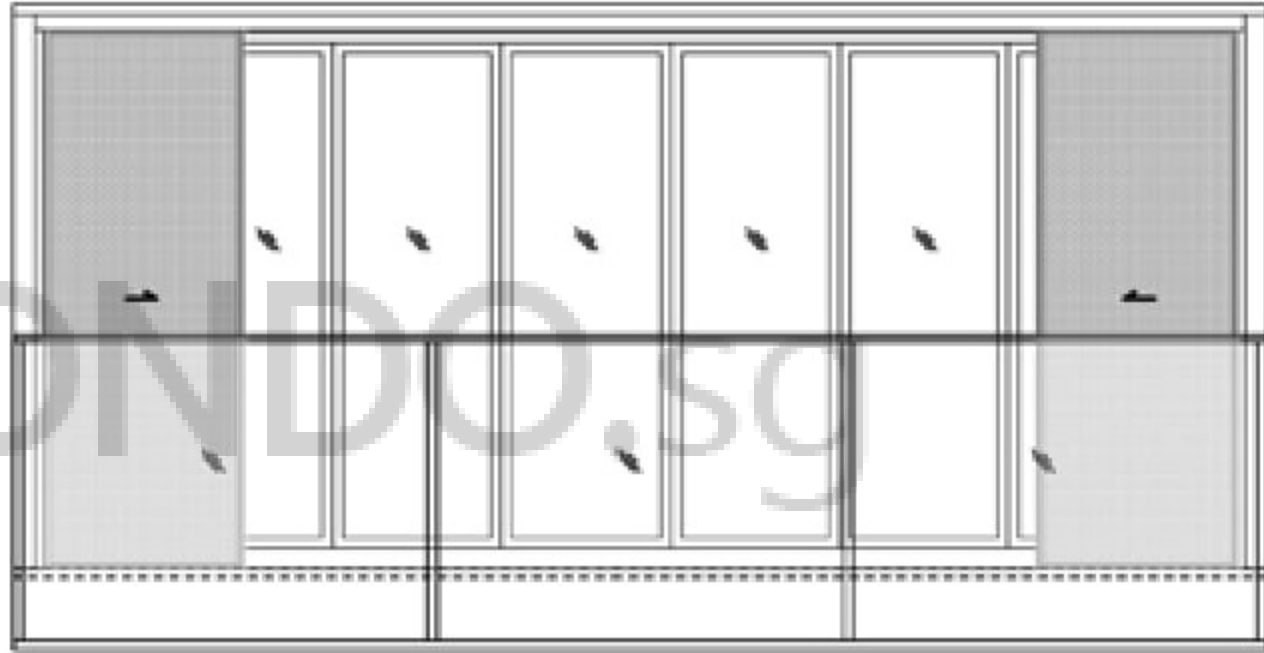

ELEVATION 1 (OPENED SCREENS)

NOTE:
 THE BALCONY SHALL NOT BE ENCLOSED UNLESS WITH THE APPROVED BALCONY SCREEN AS SHOWN ABOVE.
 THE COST OF SCREEN AND INSTALLATION SHALL BE BORNE BY THE PURCHASER.