

TYPE B3-a
49 sq m / 527 sq ft

#02-21; #06-21; #10-21; #15-21; #19-21;
#23-21; #27-21; #31-21; #35-21;

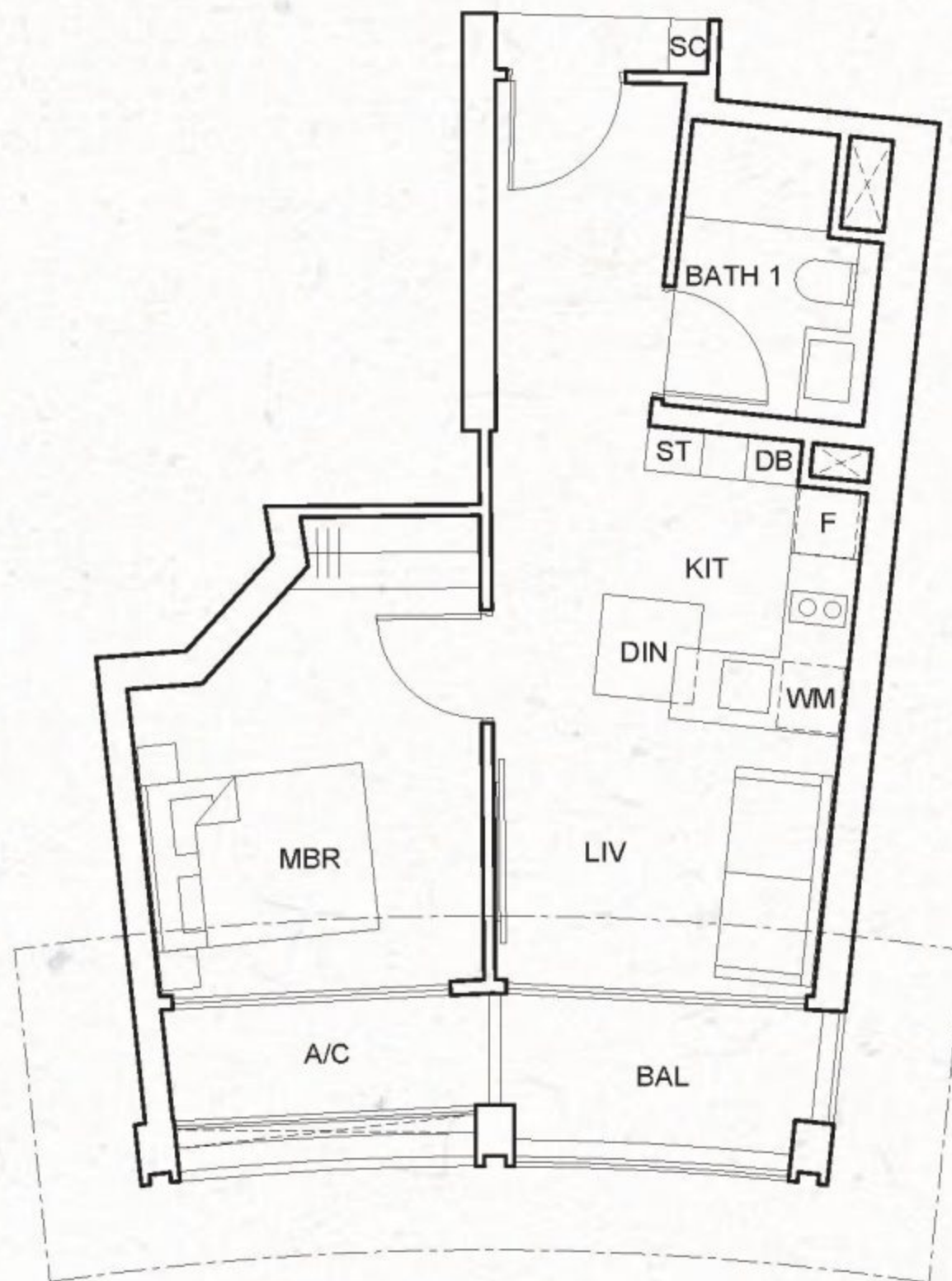

TYPE B3-b
49 sq m / 527 sq ft

#03-21; #04-21; #05-21; #07-21; #08-21;
#09-21; #11-21; #12-21; #13-21; #16-21;
#17-21; #18-21; #20-21; #21-21; #22-21;
#24-21; #25-21; #26-21; #28-21; #29-21;
#30-21; #32-21; #33-21; #34-21; #36-21;
#37-21

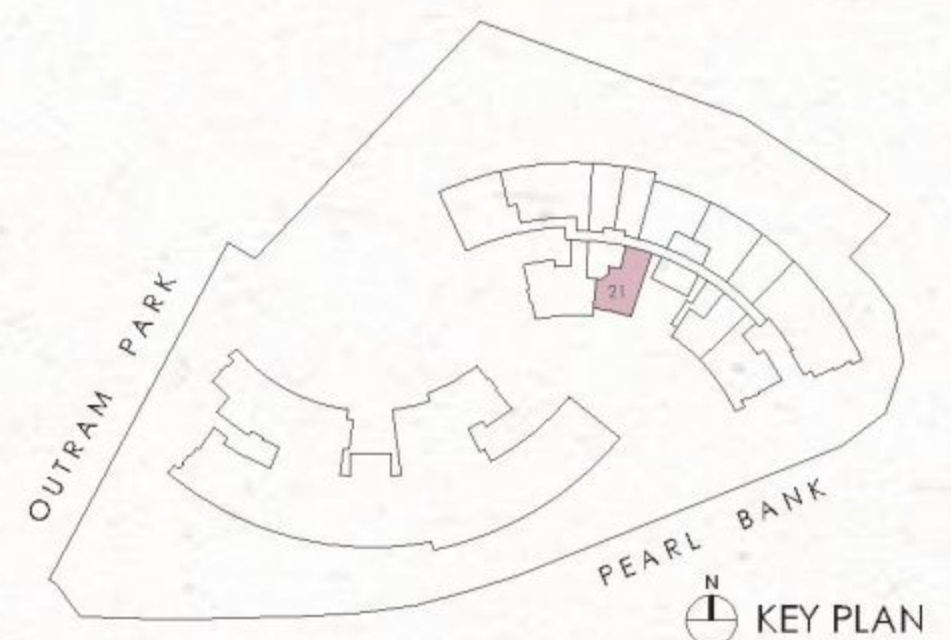
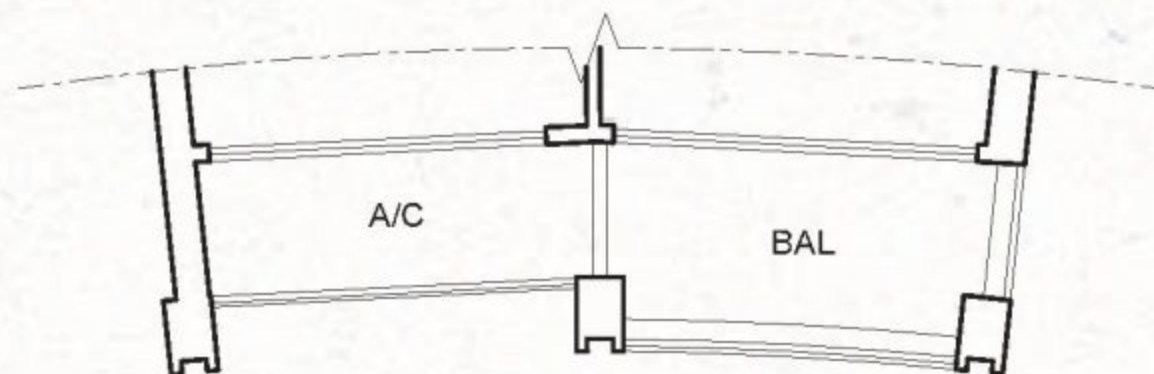

All floor areas indicated are inclusive of AC ledge, planters and balcony where applicable. The plans are subject to change as may be approved by the relevant authorities. All floor plans are approximate measurements only and subject to government re-survey. The balcony shall not be enclosed unless with the approved balcony screen. The installation and cost of the balcony screen shall be borne by the purchaser. For an illustration of the approved balcony screen, please refer to the diagram annexed hereto as "Annexure".

1-BEDROOM

TYPE B4-a
52 sq m / 560 sq ft

#02-17; #06-17; #10-17; #15-17; #19-17;
#23-17; #27-17; #31-17; #35-17;

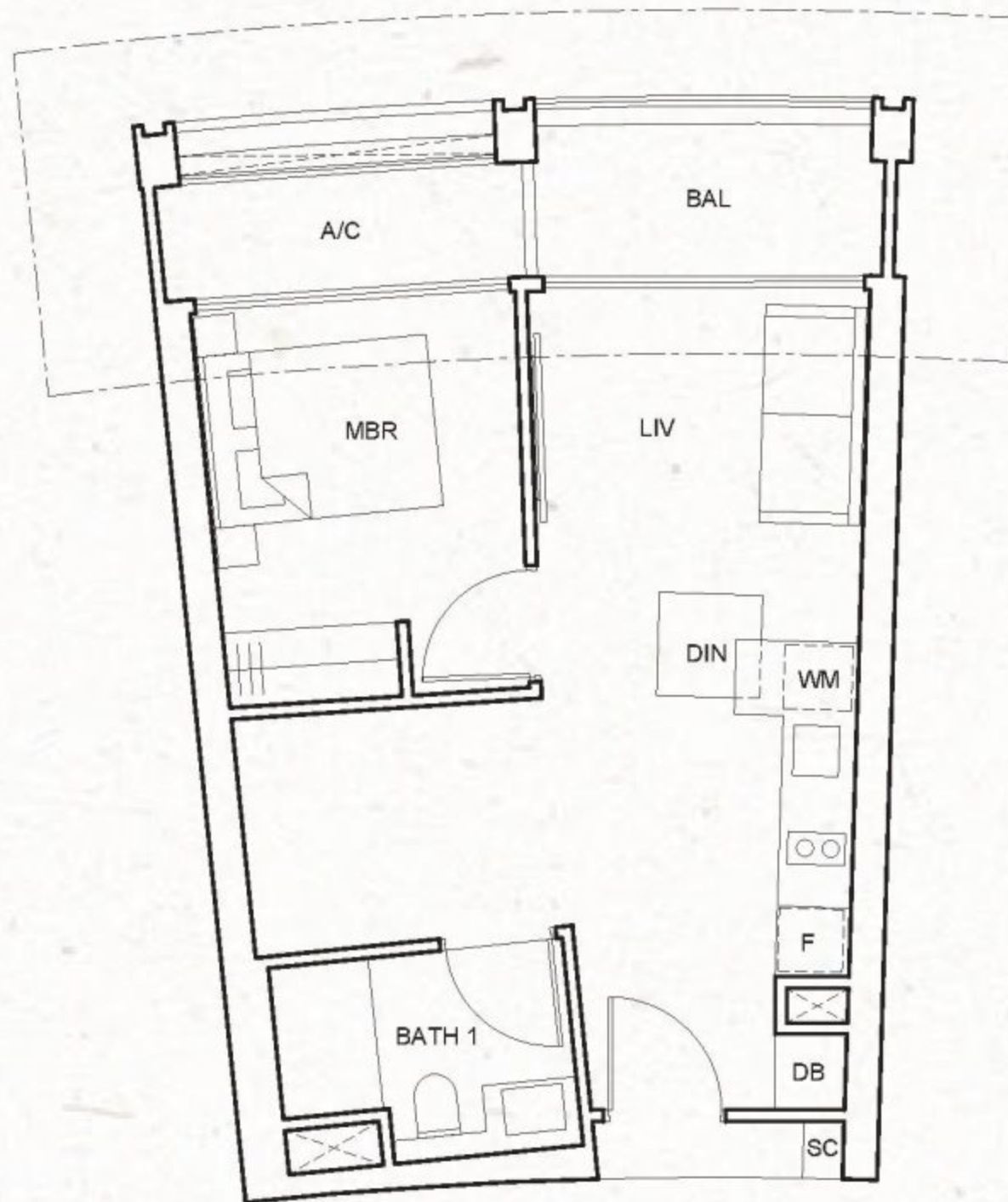

TYPE B4-b
52 sq m / 560 sq ft

#03-17; #04-17; #05-17; #07-17; #08-17;
#09-17; #11-17; #12-17; #13-17; #16-17;
#17-17; #18-17; #20-17; #21-17; #22-17;
#24-17; #25-17; #26-17; #28-17; #29-17;
#30-17; #32-17; #33-17; #34-17; #36-17;
#37-17;

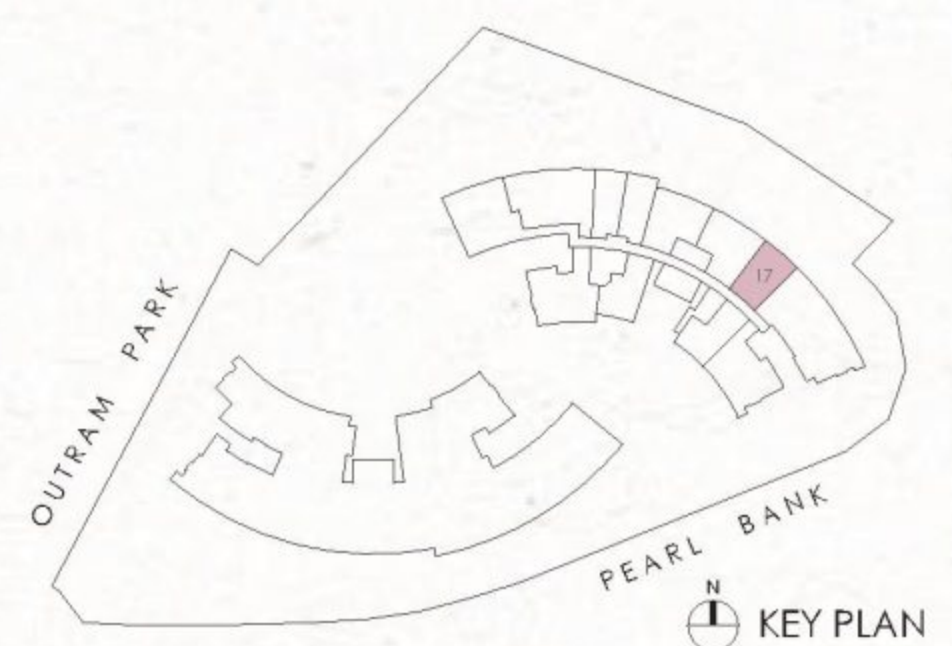
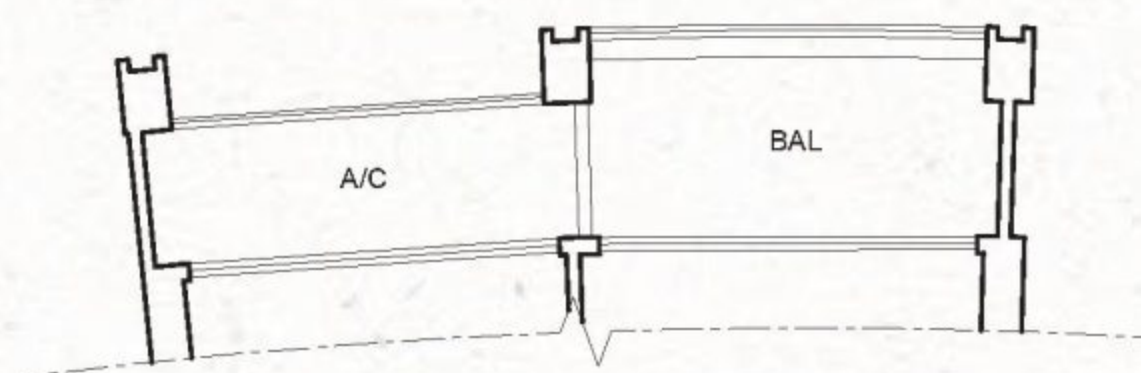

All floor areas indicated are inclusive of AC ledge, planters and balcony where applicable. The plans are subject to change as may be approved by the relevant authorities. All floor plans are approximate measurements only and subject to government re-survey. The balcony shall not be enclosed unless with the approved balcony screen. The installation and cost of the balcony screen shall be borne by the purchaser. For an illustration of the approved balcony screen, please refer to the diagram annexed hereto as "Annexure".

2-BEDROOM

TYPE C2-a
69 sq m / 743 sq ft

#02-06; #06-06; #10-06; #14-06; #19-06;
#23-06; #27-06; #31-06; #35-06

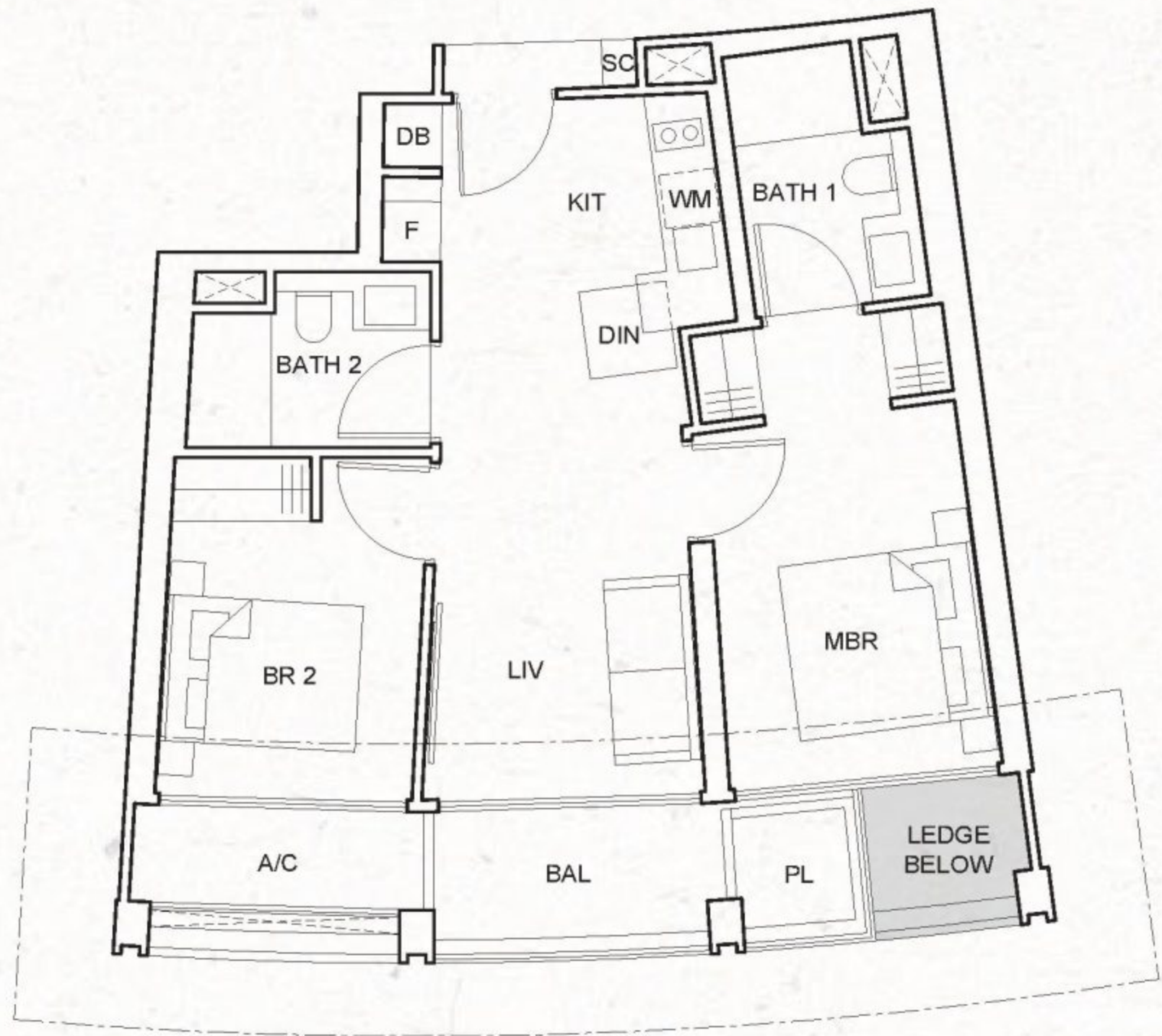

TYPE C2-b
69 sq m / 743 sq ft

#03-06; #05-06; #07-06; #09-06; #11-06;
#13-06; #15-06; #17-06; #20-06; #22-06;
#24-06; #26-06; #28-06; #30-06; #32-06;
#34-06; #36-06

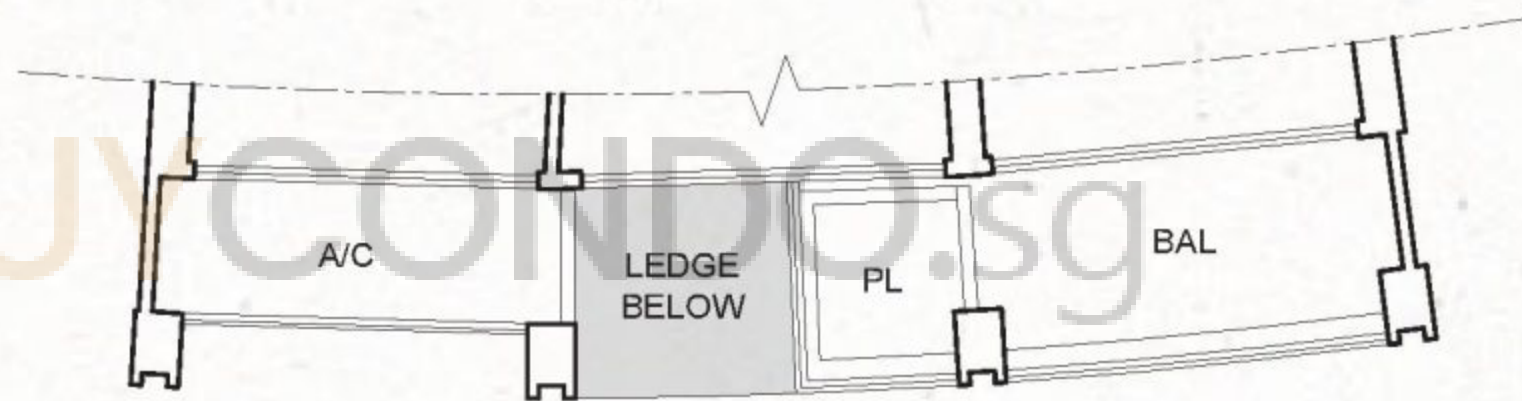

TYPE C2-c
69 sq m / 743 sq ft

#04-06; #08-06; #12-06; #16-06; #21-06;
#25-06; #29-06; #33-06; #37-06

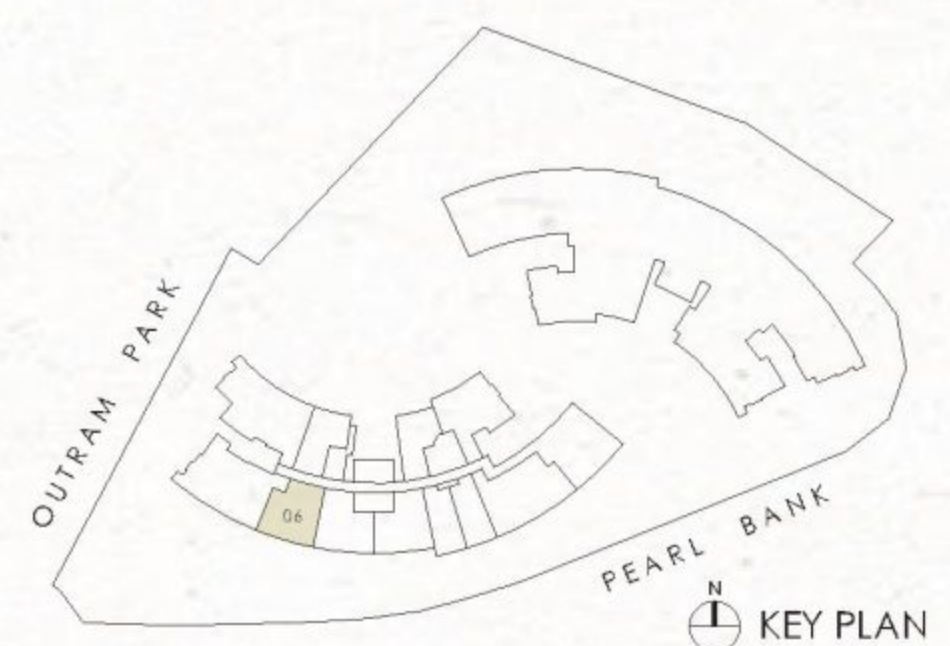
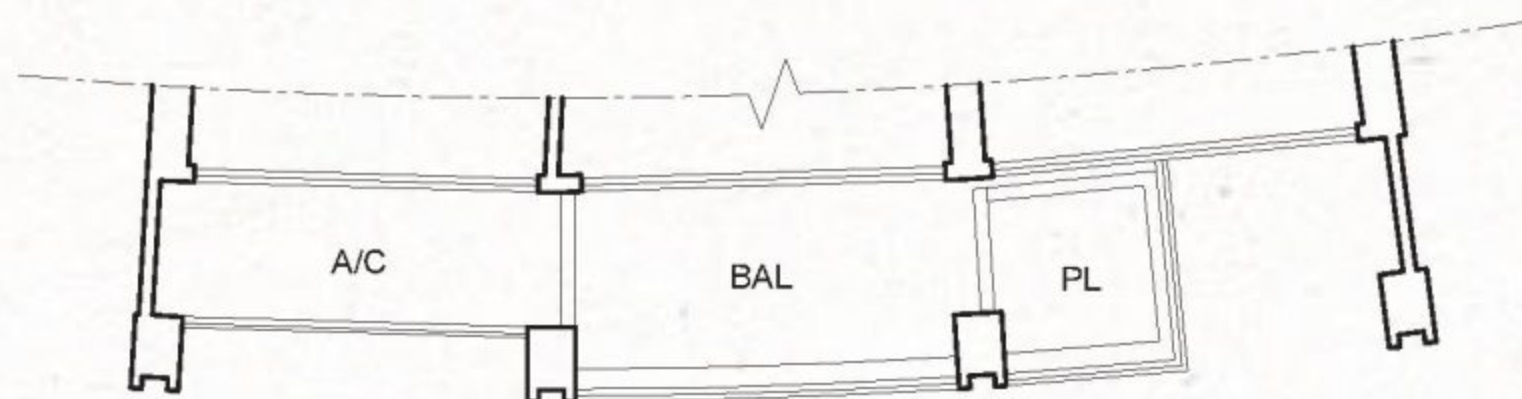

All floor areas indicated are inclusive of AC ledge, planters and balcony where applicable. The plans are subject to change as may be approved by the relevant authorities. All floor plans are approximate measurements only and subject to government re-survey. The balcony shall not be enclosed unless with the approved balcony screen. The installation and cost of the balcony screen shall be borne by the purchaser. For an illustration of the approved balcony screen, please refer to the diagram annexed hereto as "Annexure".

1-BEDROOM

TYPE B2-a
49 sq m / 527 sq ft

#02-10; #06-10; #10-10; #14-10; #19-10;
#23-10; #27-10; #31-10; #35-10;

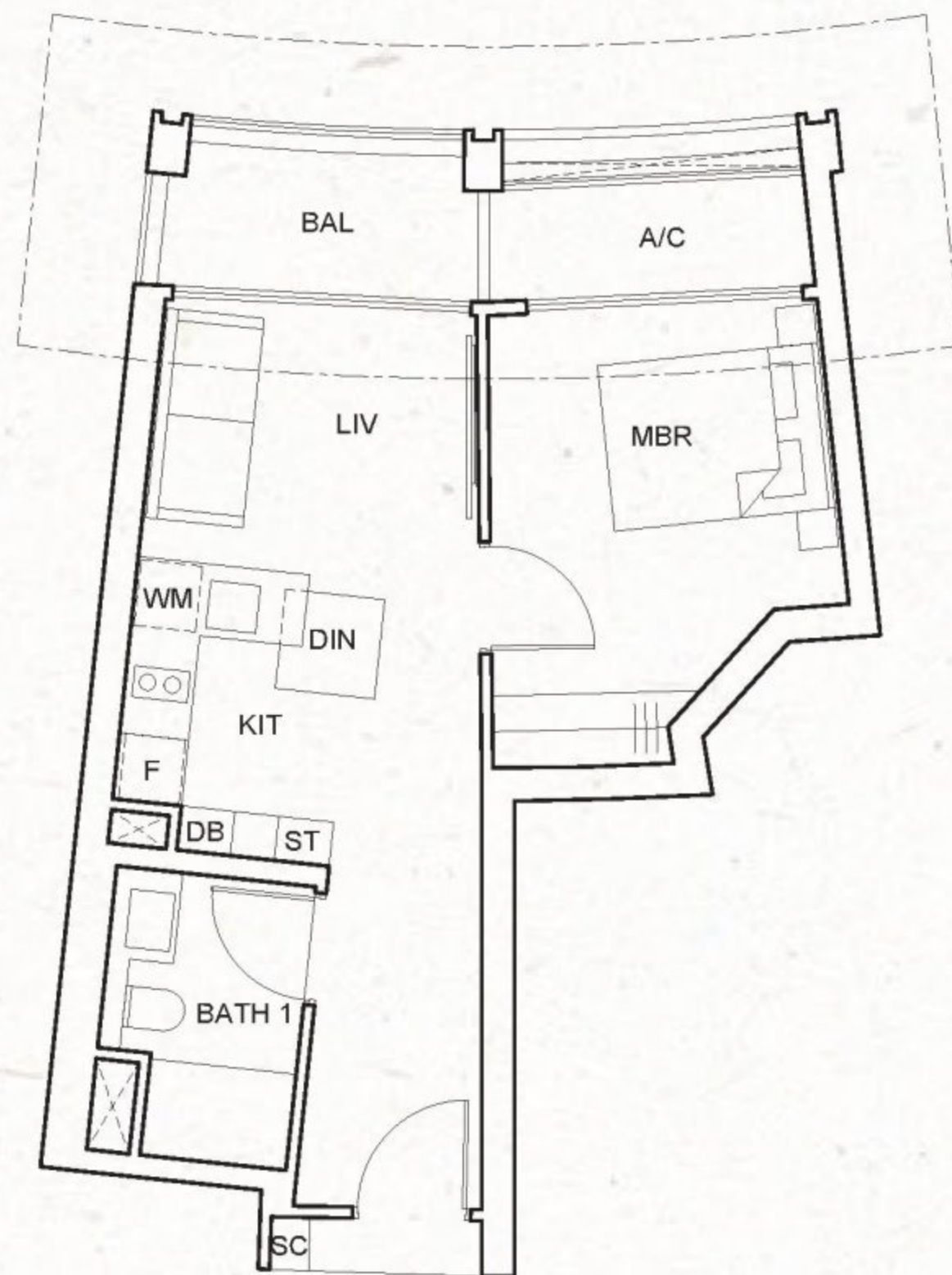

TYPE B2-b
49 sq m / 527 sq ft

#03-10; #04-10; #05-10; #07-10; #08-10;
#09-10; #11-10; #12-10; #13-10; #15-10;
#16-10; #17-10; #20-10; #21-10; #22-10;
#24-10; #25-10; #26-10; #28-10; #29-10;
#30-10; #32-10; #33-10; #34-10; #36-10;
#37-10

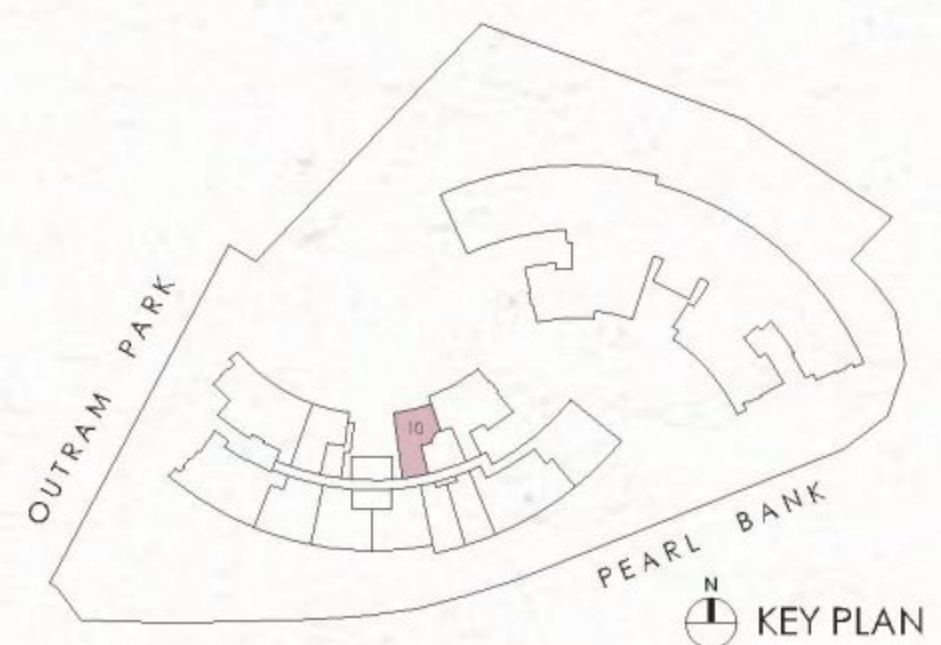
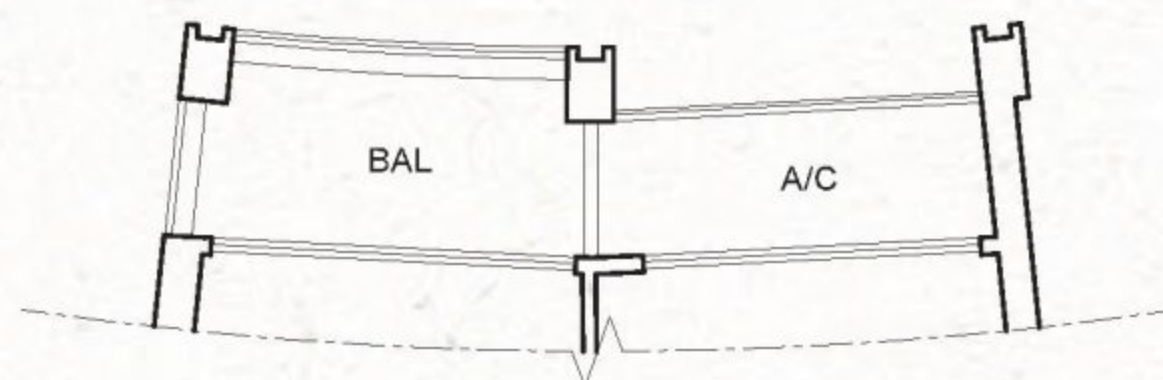

All floor areas indicated are inclusive of AC ledge, planters and balcony where applicable. The plans are subject to change as may be approved by the relevant authorities. All floor plans are approximate measurements only and subject to government re-survey. The balcony shall not be enclosed unless with the approved balcony screen. The installation and cost of the balcony screen shall be borne by the purchaser. For an illustration of the approved balcony screen, please refer to the diagram annexed hereto as "Annexure".

TYPE A1-a
40 sq m / 431 sq ft

#02-03; #06-03; #10-03; #14-03; #19-03;
#23-03; #27-03; #31-03; #35-03;

#02-14; #06-14; #10-14; #15-14; #19-14;
#23-14; #27-14; #31-14; #35-14

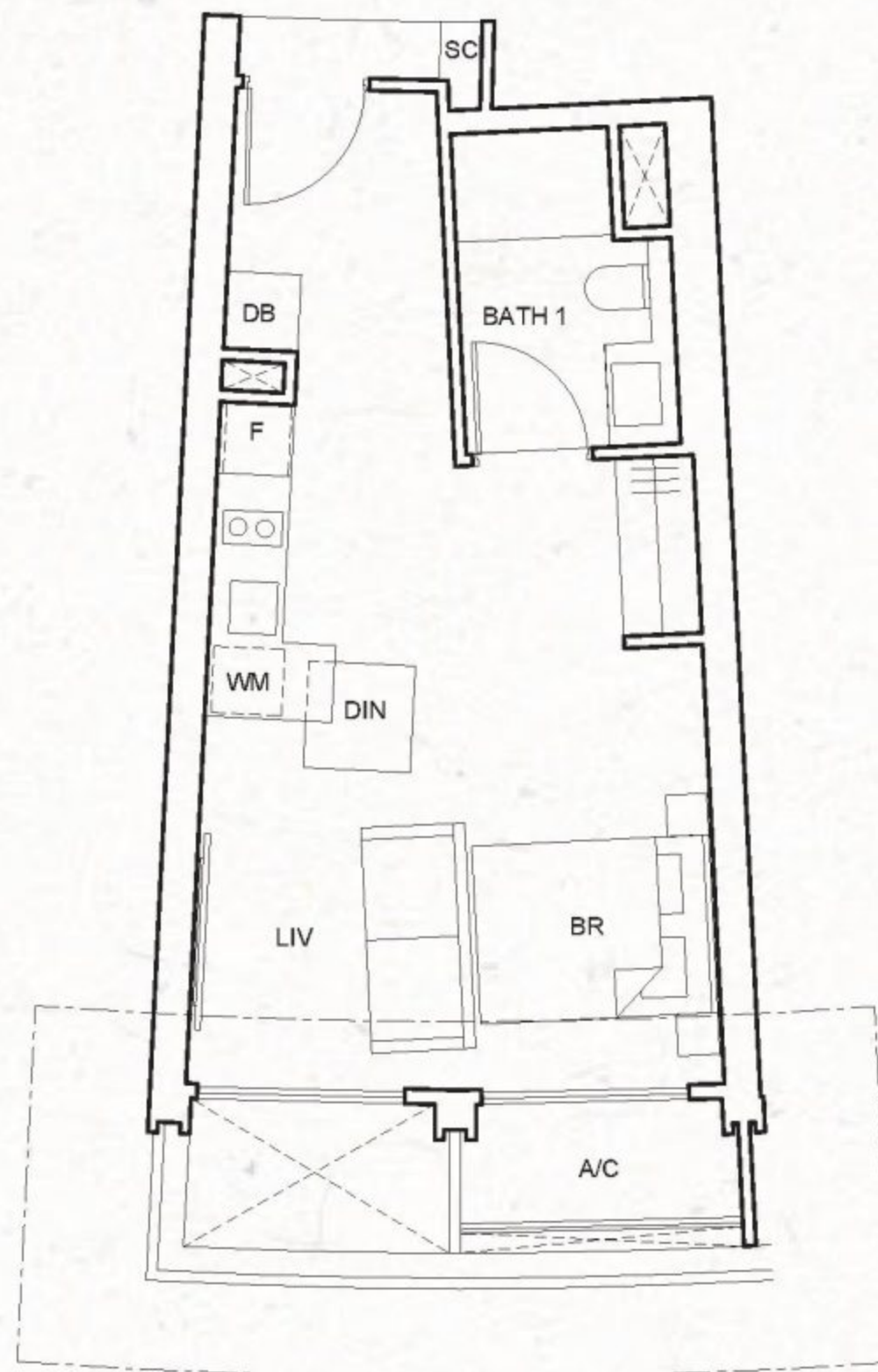

 BUYCONDO.sg

TYPE A1-b
40 sq m / 431 sq ft

#03-03; #04-03; #05-03; #07-03; #08-03;
#09-03; #11-03; #12-03; #13-03; #15-03;
#16-03; #17-03; #20-03; #21-03; #22-03;
#24-03; #25-03; #26-03; #28-03; #29-03;
#30-03; #32-03; #33-03; #34-03; #36-03;
#37-03;

#03-14; #04-14; #05-14; #07-14; #08-14;
#09-14; #11-14; #12-14; #13-14; #16-14;
#17-14; #18-14; #20-14; #21-14; #22-14;
#24-14; #25-14; #26-14; #28-14; #29-14;
#30-14; #32-14; #33-14; #34-14; #36-14;
#37-14;

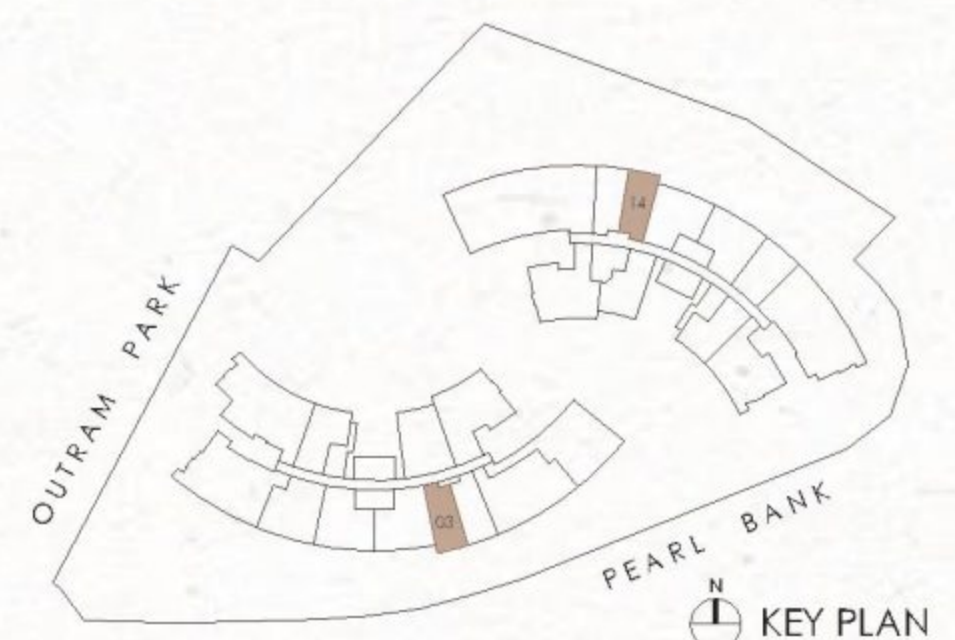
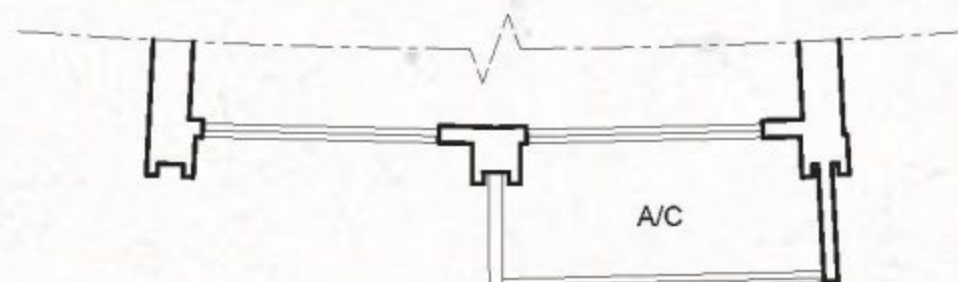

3-BEDROOM

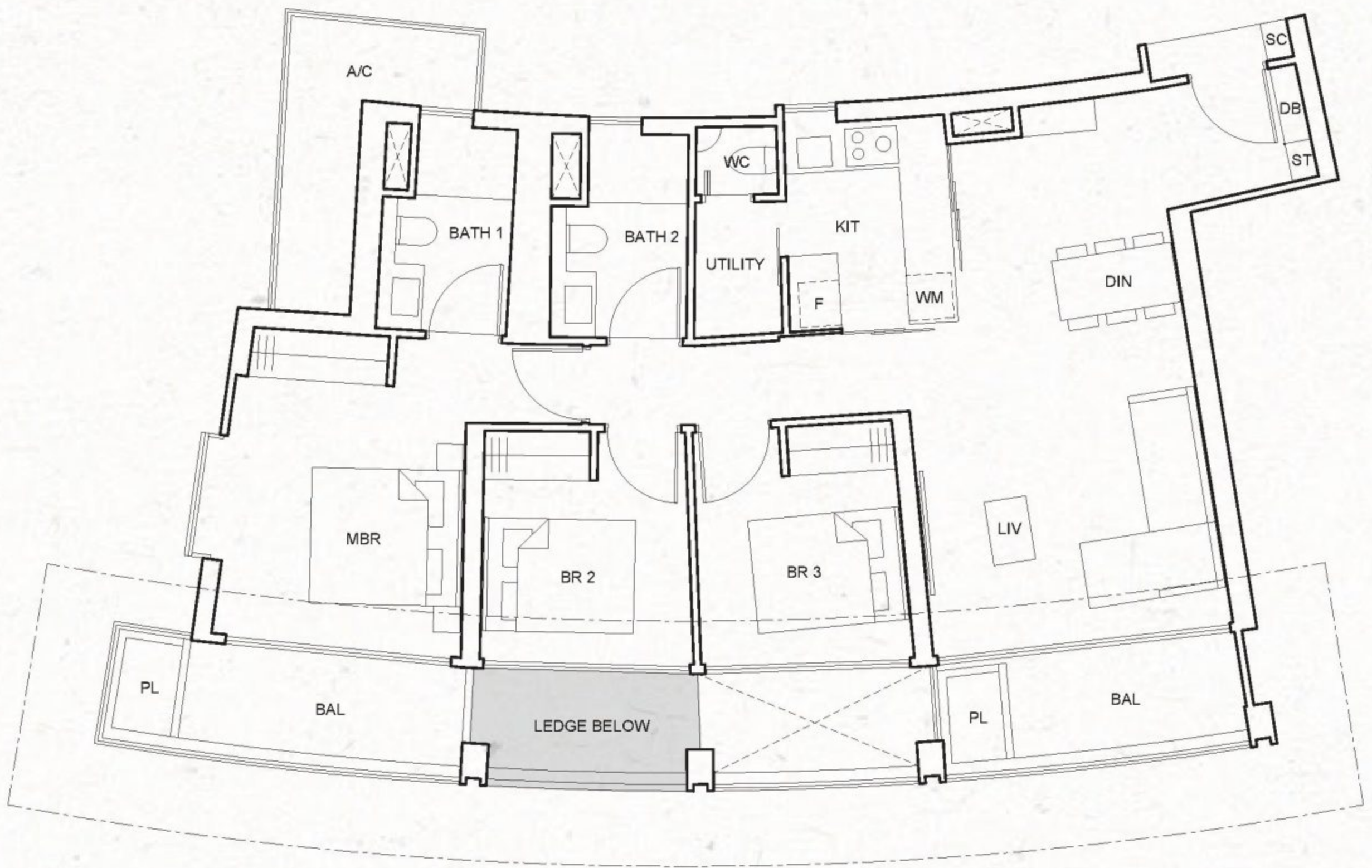

TYPE D2-a
113 sq m / 1,216 sq ft

#02-07; #06-07; #10-07; #14-07; #19-07;
#23-07; #27-07; #31-07; #35-07

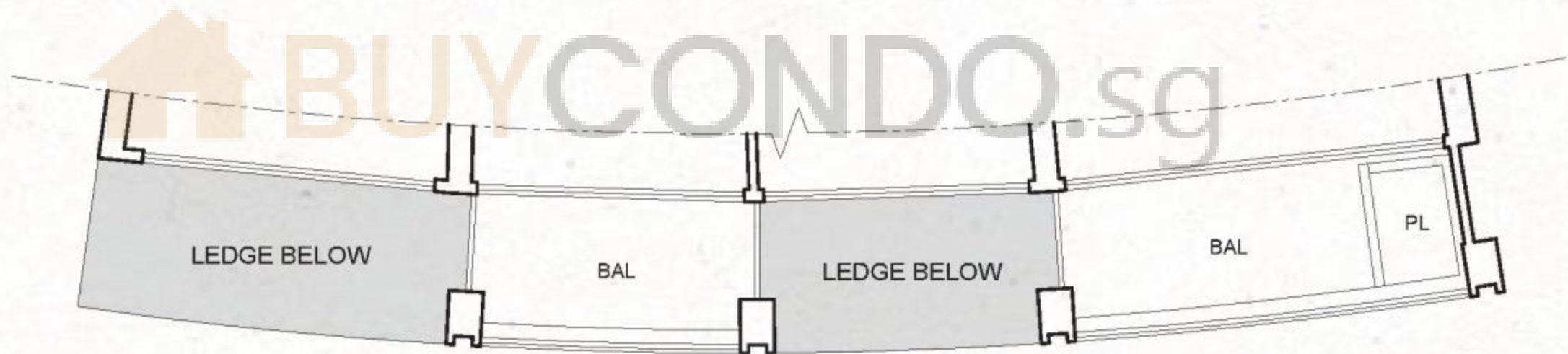

TYPE D2-b
110 sq m / 1,184 sq ft

#03-07; #05-07; #07-07; #09-07; #11-07;
#13-07; #15-07; #17-07; #20-07; #22-07;
#24-07; #26-07; #28-07; #30-07; #32-07;
#34-07; #36-07

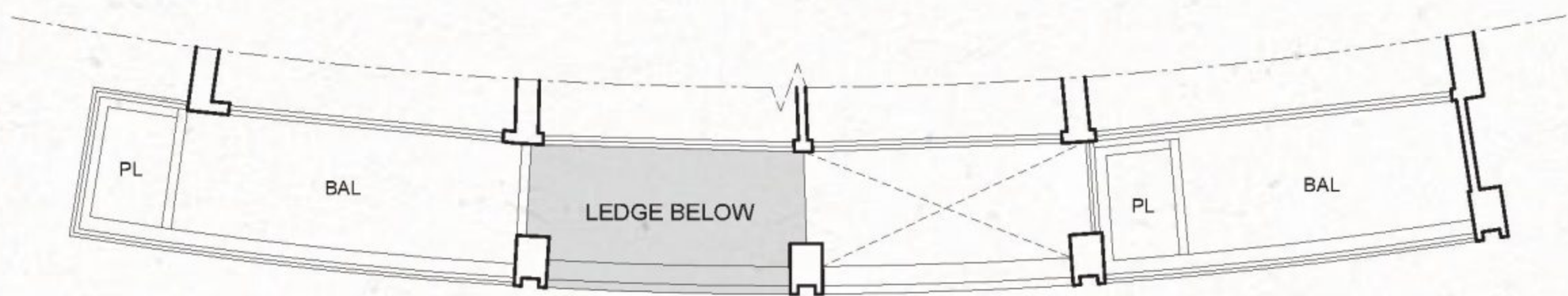

TYPE D2-c
113 sq m / 1,216 sq ft

#04-07; #08-07; #12-07; #16-07; #21-07;
#25-07; #29-07; #33-07; #37-07



STUDIO

TYPE A1-a(m)
40 sq m / 431 sq ft

#02-02; #06-02; #10-02; #14-02; #19-02;
#23-02; #27-02; #31-02; #35-02;

#02-13; #06-13; #10-13; #15-13; #19-13;
#23-13; #27-13; #31-13; #35-13

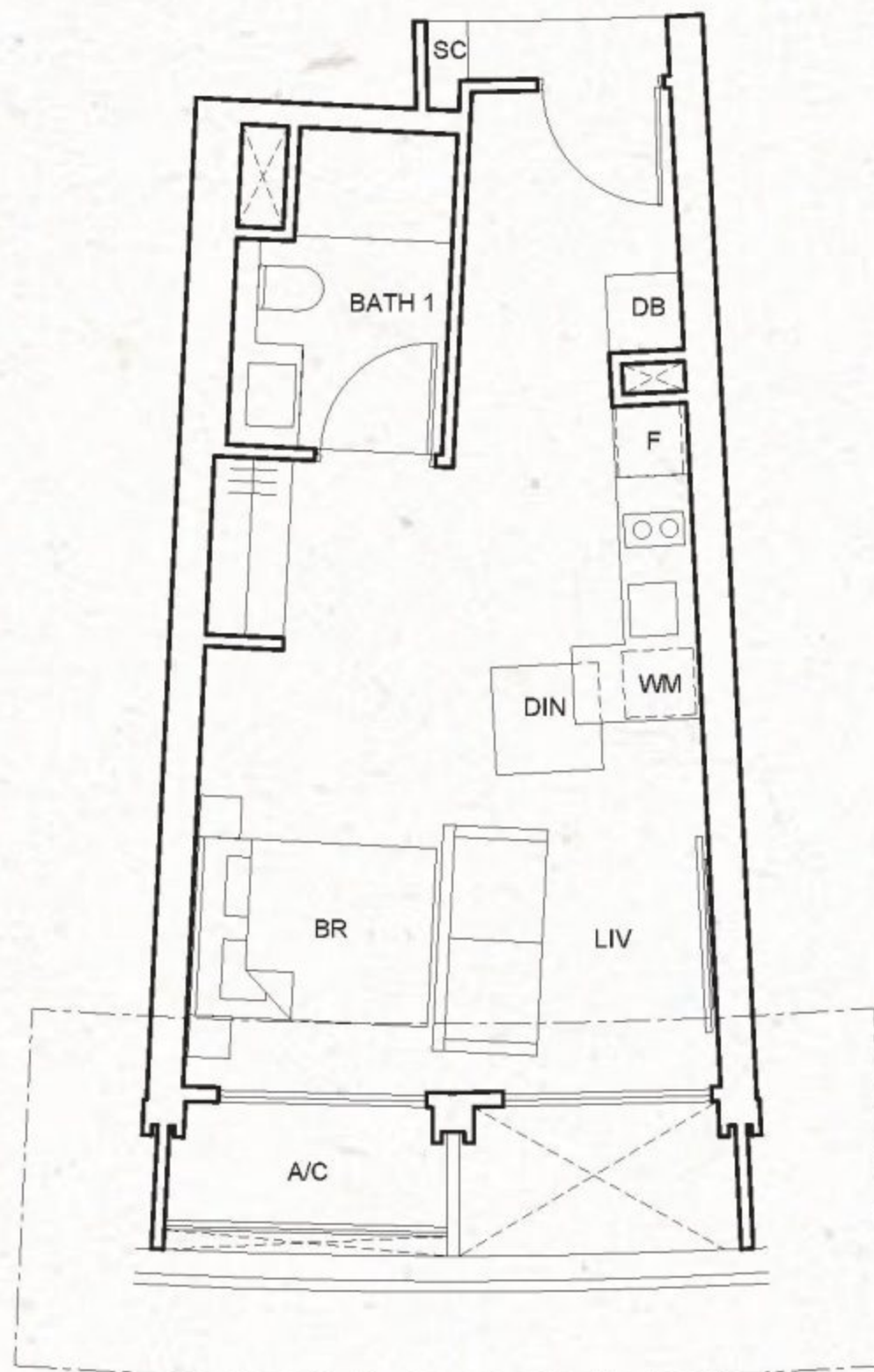

TYPE A1-b(m)
40 sq m / 431 sq ft

#03-02; #04-02; #05-02; #07-02; #08-02;
#09-02; #11-02; #12-02; #13-02; #15-02;
#16-02; #17-02; #20-02; #21-02; #22-02;
#24-02; #25-02; #26-02; #28-02; #29-02;
#30-02; #32-02; #33-02; #34-02; #36-02;
#37-02;

#03-13; #04-13; #05-13; #07-13; #08-13;
#09-13; #11-13; #12-13; #13-13; #16-13;
#17-13; #18-13; #20-13; #21-13; #22-13;
#24-13; #25-13; #26-13; #28-13; #29-13;
#30-13; #32-13; #33-13; #34-13; #36-13;
#37-13;

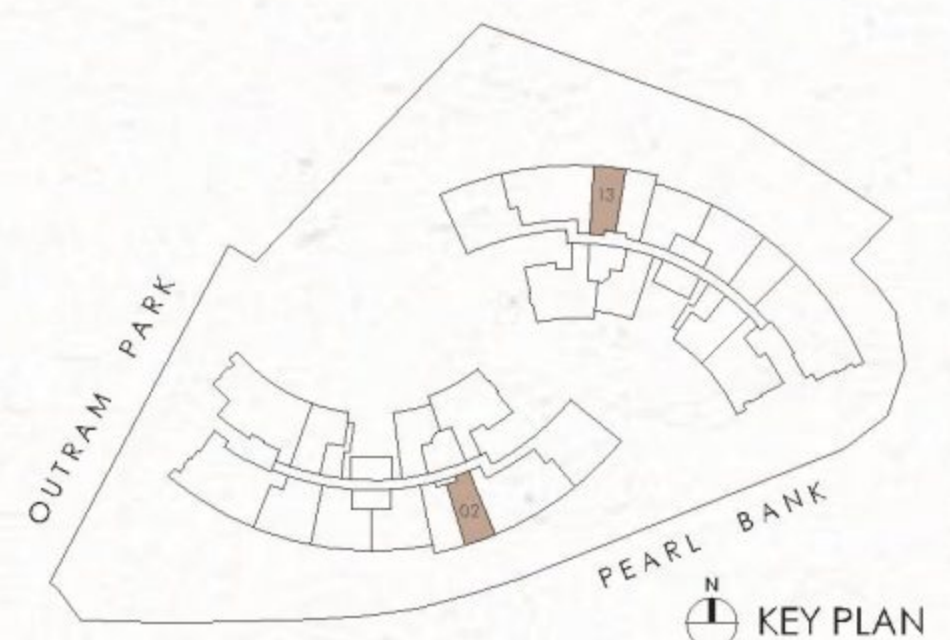
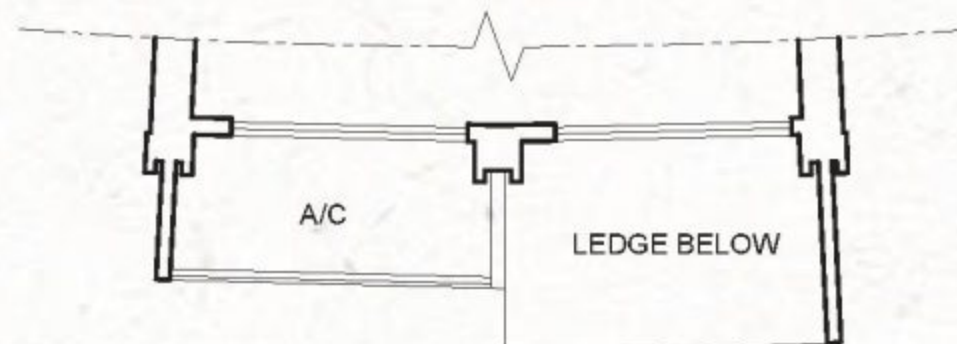

All floor areas indicated are inclusive of AC ledge, planters and balcony where applicable. The plans are subject to change as may be approved by the relevant authorities. All floor plans are approximate measurements only and subject to government re-survey. The balcony shall not be enclosed unless with the approved balcony screen. The installation and cost of the balcony screen shall be borne by the purchaser. For an illustration of the approved balcony screen, please refer to the diagram annexed hereto as "Annexure".

3-BEDROOM

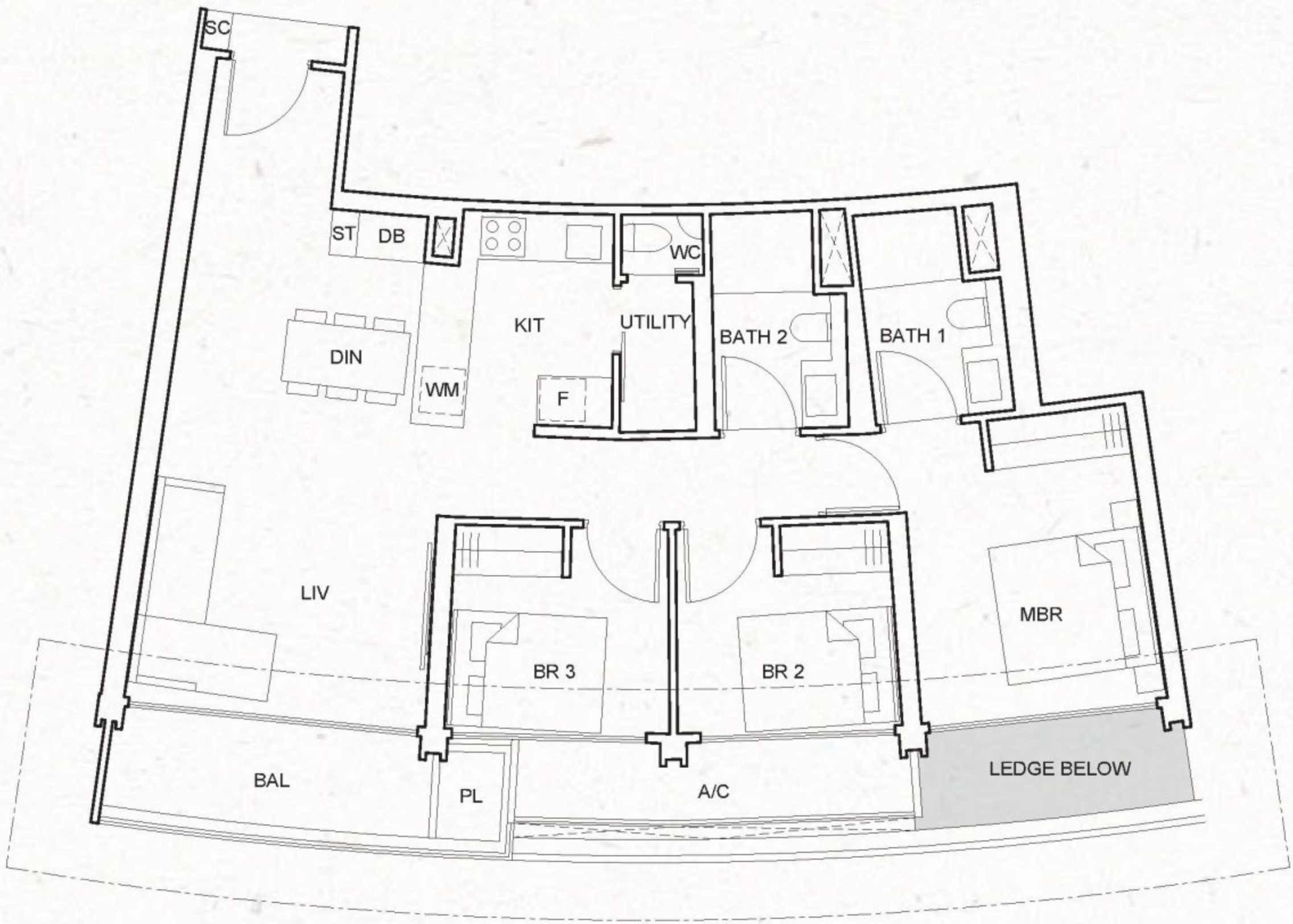

TYPE D1-a
102 sq m / 1,098 sq ft

#02-01; #06-01; #10-01; #14-01;
#19-01; #23-01; #27-01; #31-01;
#35-01;

#02-12; #06-12; #10-12; #15-12;
#19-12; #23-12; #27-12; #31-12;
#35-12

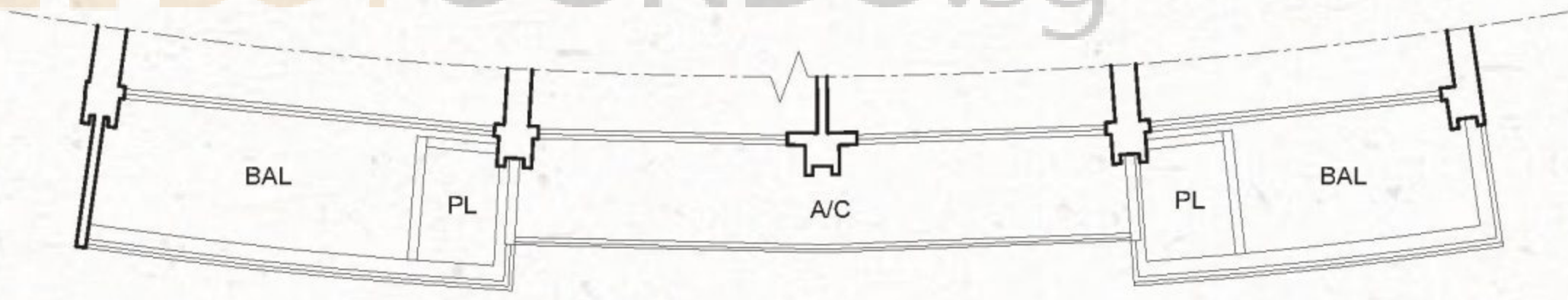

TYPE D1-b
107 sq m / 1,152 sq ft

#03-01; #05-01; #07-01; #09-01; #11-01;
#13-01; #15-01; #17-01; #20-01; #22-01;
#24-01; #26-01; #28-01; #30-01; #32-01;
#34-01; #36-01;

#03-12; #05-12; #07-12; #09-12; #11-12;
#13-12; #16-12; #18-12; #20-12; #22-12;
#24-12; #26-12; #28-12; #30-12; #32-12;
#34-12; #36-12

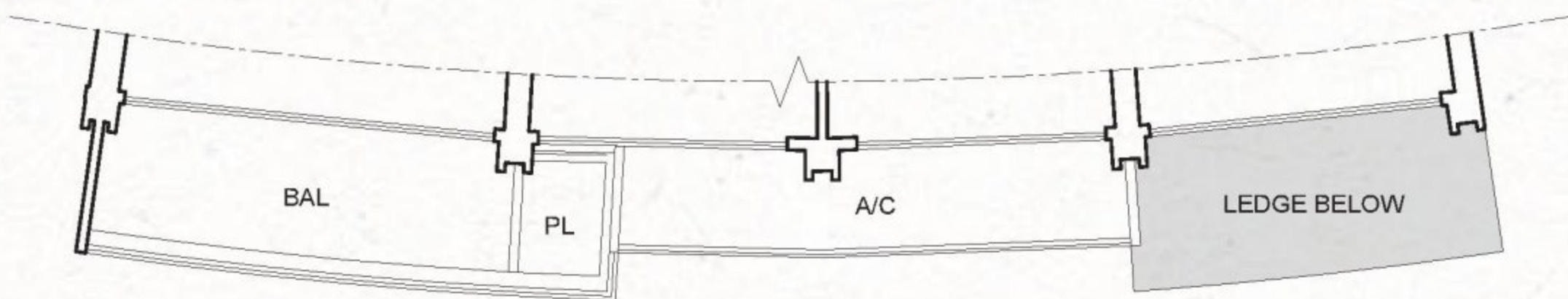

TYPE D1-c
102 sq m / 1,098 sq ft

#04-01; #08-01; #12-01; #16-01; #21-01;
#25-01; #29-01; #33-01; #37-01;

#04-12; #08-12; #12-12; #17-12; #21-12;
#25-12; #29-12; #33-12; #37-12

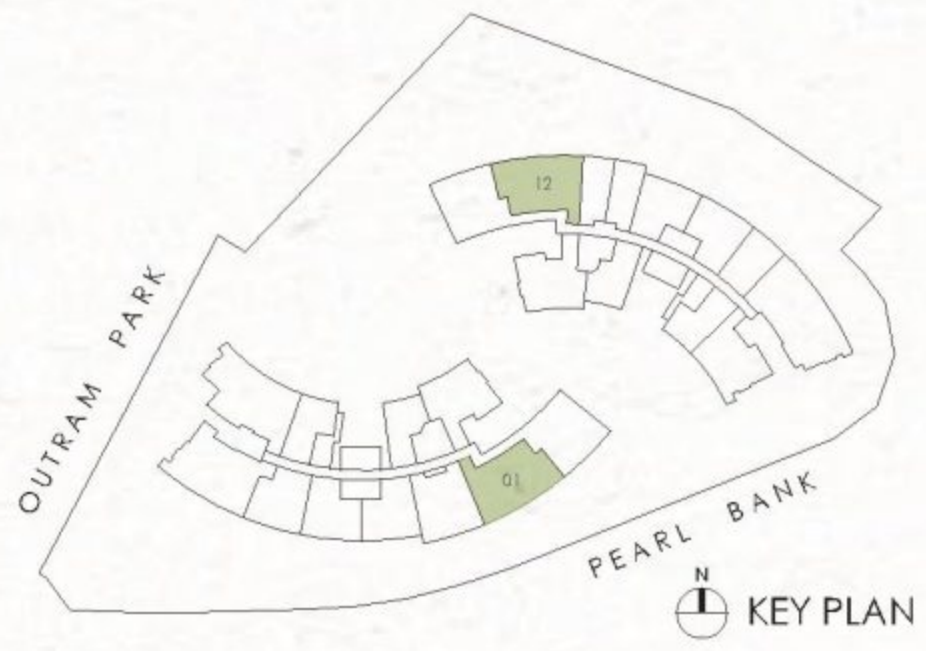

KEY PLAN

All floor areas indicated are inclusive of AC ledge, planters and balcony where applicable. The plans are subject to change as may be approved by the relevant authorities. All floor plans are approximate measurements only and subject to government re-survey. The balcony shall not be enclosed unless with the approved balcony screen. The installation and cost of the balcony screen shall be borne by the purchaser. For an illustration of the approved balcony screen, please refer to the diagram annexed hereto as "Annexure".

3-BEDROOM

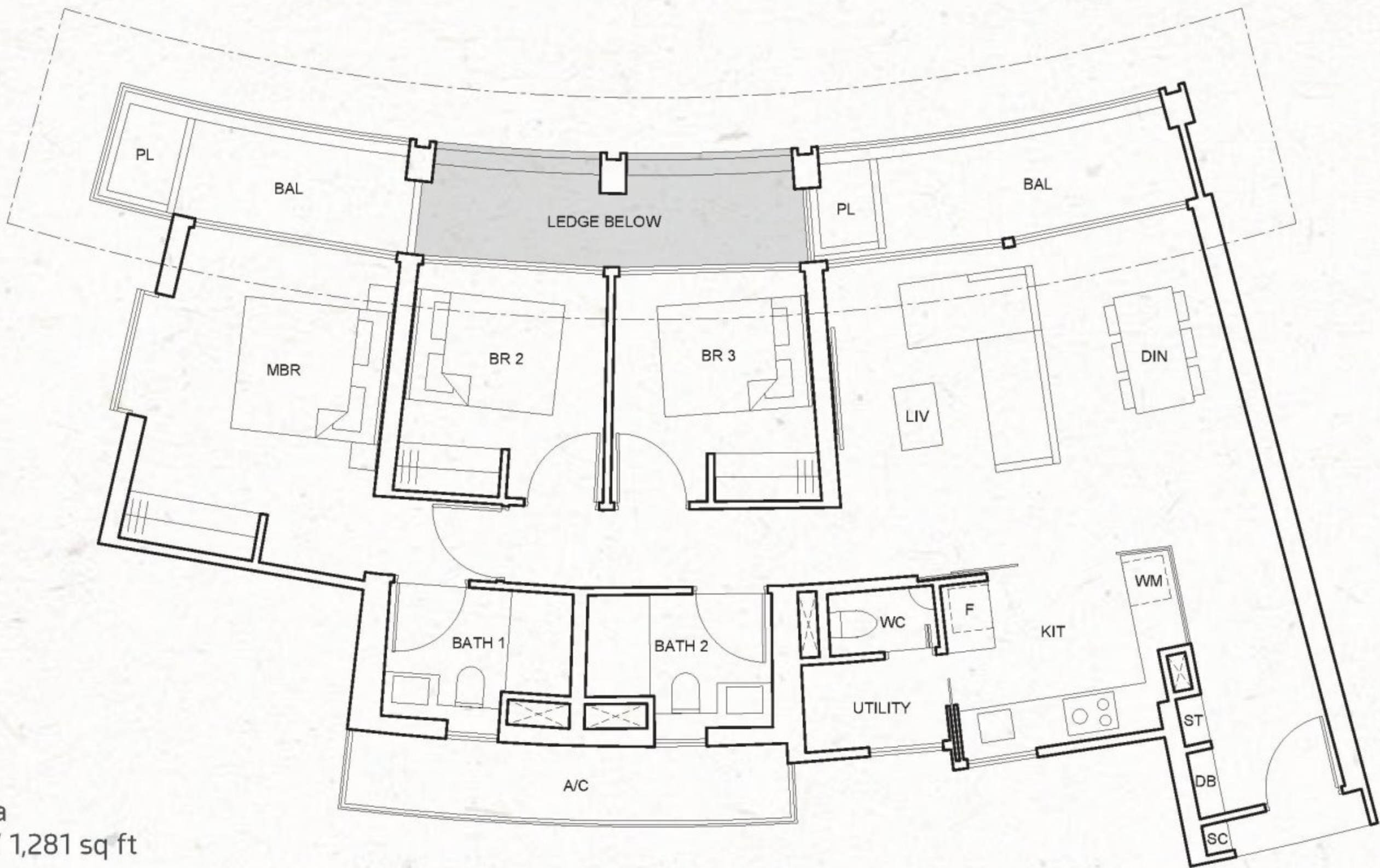

TYPE D3-a
119 sq m / 1,281 sq ft

- #02-08; #06-08; #10-08; #14-08; #19-08;
- #23-08; #27-08; #31-08; #35-08

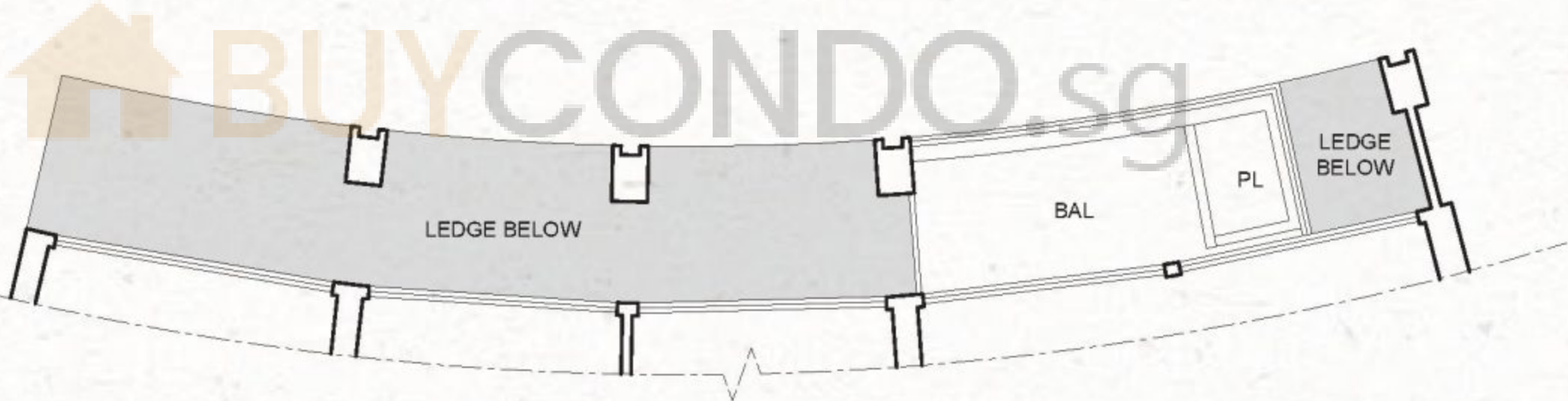

TYPE D3-b
111 sq m / 1,195 sq ft

- #03-08; #05-08; #07-08; #09-08; #11-08;
- #13-08; #15-08; #17-08; #20-08; #22-08;
- #24-08; #26-08; #28-08; #30-08; #32-08;
- #34-08; #36-08

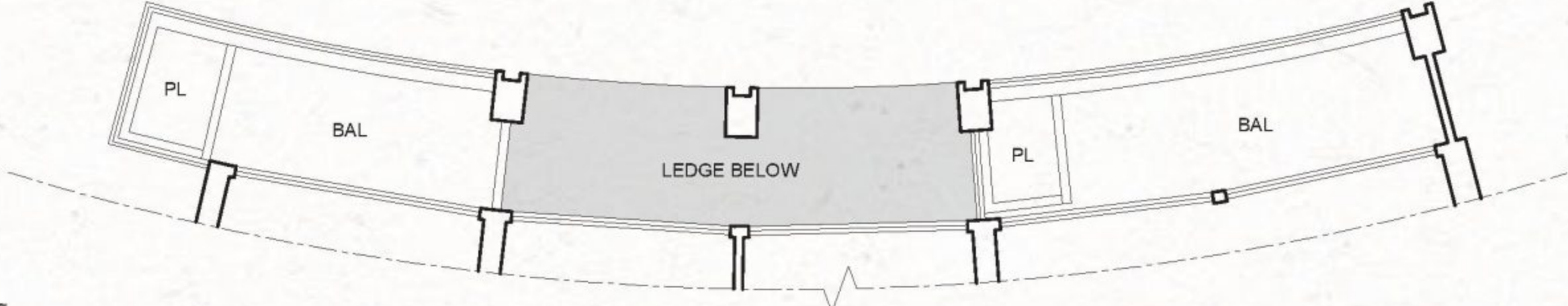

TYPE D3-c
119 sq m / 1,281 sq ft

- #04-08; #08-08; #12-08; #16-08; #21-08;
- #25-08; #29-08; #33-08; #37-08

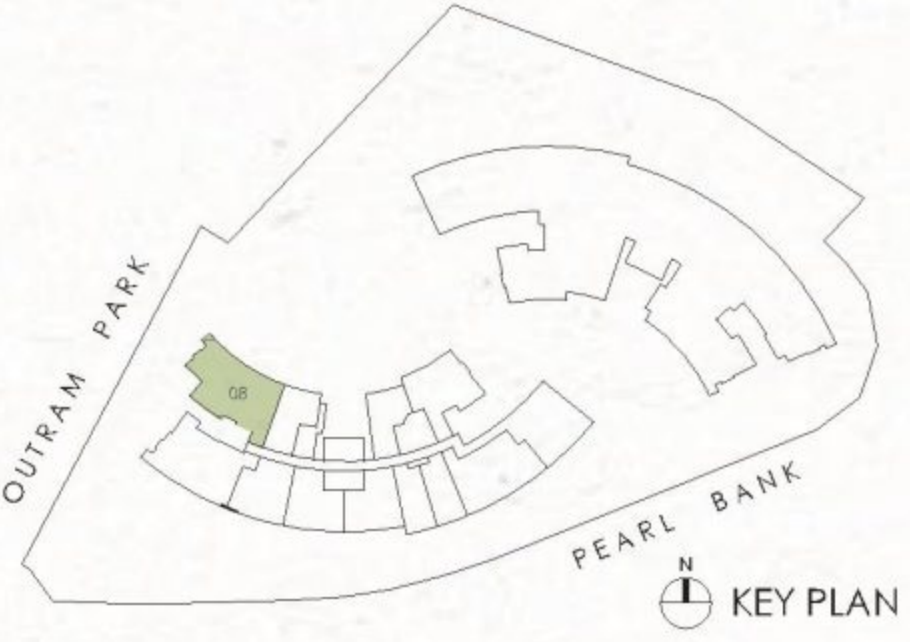

KEY PLAN

All floor areas indicated are inclusive of AC ledge, planters and balcony where applicable. The plans are subject to change as may be approved by the relevant authorities. All floor plans are approximate measurements only and subject to government re-survey. The balcony shall not be enclosed unless with the approved balcony screen. The installation and cost of the balcony screen shall be borne by the purchaser. For an illustration of the approved balcony screen, please refer to the diagram annexed hereto as "Annexure".

2-BEDROOM

TYPE C3-a

83 sq m / 893 sq ft

#02-11; #06-11; #10-11; #14-11; #19-11;
#23-11; #27-11; #31-11; #35-11;

#02-22; #06-22; #10-22; #15-22; #19-22;
#23-22; #27-22; #31-22; #35-22

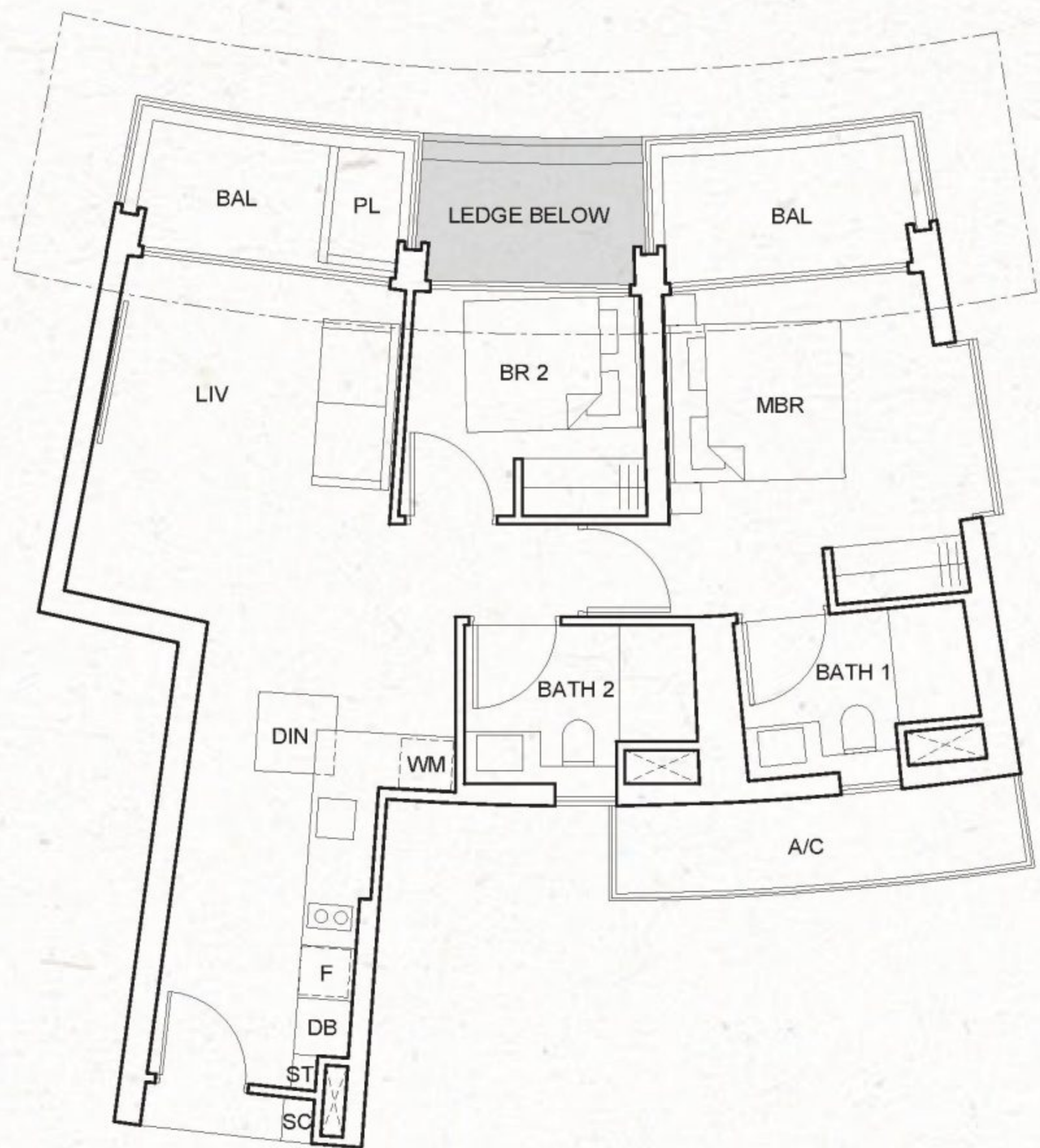

TYPE C3-b

78 sq m / 840 sq ft

#03-11; #05-11; #07-11; #09-11; #11-11;
#13-11; #15-11; #17-11; #20-11; #22-11;
#24-11; #26-11; #28-11; #30-11; #32-11;
#34-11; #36-11;

#03-22; #05-22; #07-22; #09-22; #11-22;
#13-22; #16-22; #18-22; #20-22; #22-22;
#24-22; #26-22; #28-22; #30-22; #32-22;
#34-22; #36-22

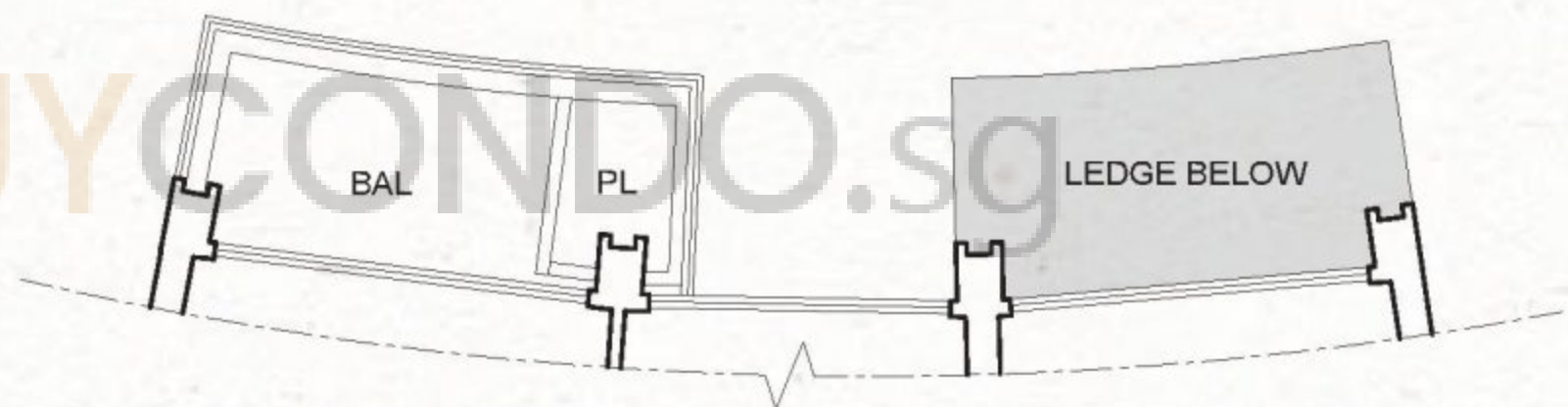

TYPE C3-c

83 sq m / 893 sq ft

#04-11; #08-11; #12-11; #16-11; #21-11;
#25-11; #29-11; #33-11; #37-11;

#04-22; #08-22; #12-22; #17-22; #21-22;
#25-22; #29-22; #33-22; #37-22

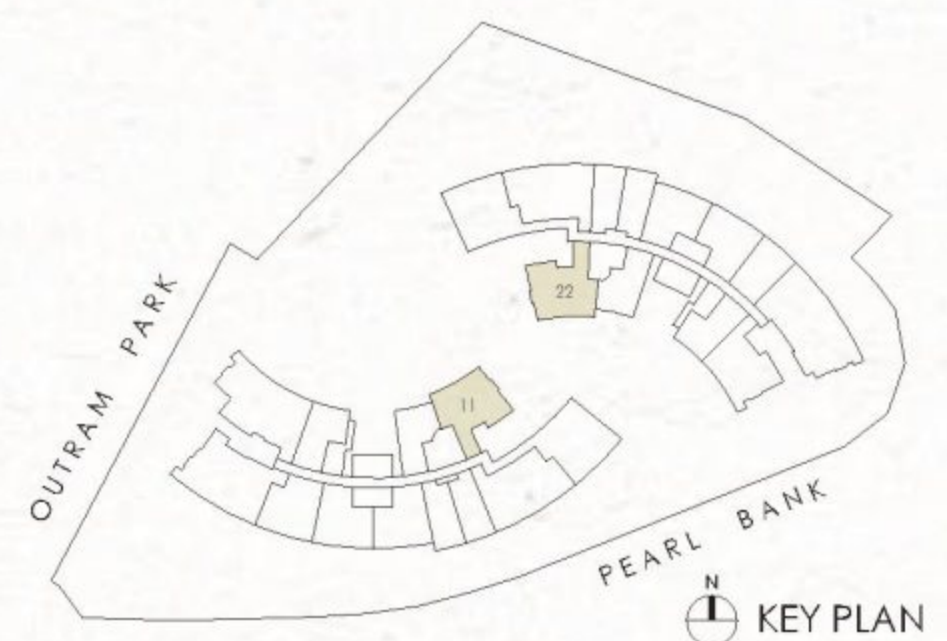
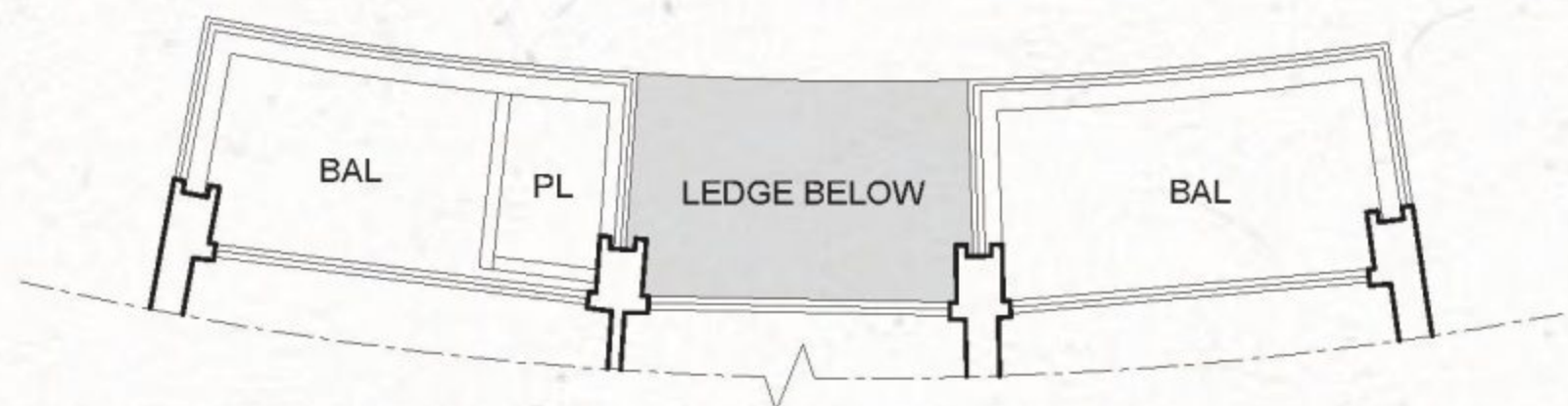

All floor areas indicated are inclusive of AC ledge, planters and balcony where applicable. The plans are subject to change as may be approved by the relevant authorities. All floor plans are approximate measurements only and subject to government re-survey. The balcony shall not be enclosed unless with the approved balcony screen. The installation and cost of the balcony screen shall be borne by the purchaser. For an illustration of the approved balcony screen, please refer to the diagram annexed hereto as "Annexure".

1-BEDROOM

TYPE B1-a
53 sq m / 570 sq ft

#02-09; #06-09; #10-09; #14-09; #19-09;
#23-09; #27-09; #31-09; #35-09;

#02-20; #06-20; #10-20; #15-20; #19-20;
#23-20; #27-20; #31-20; #35-20

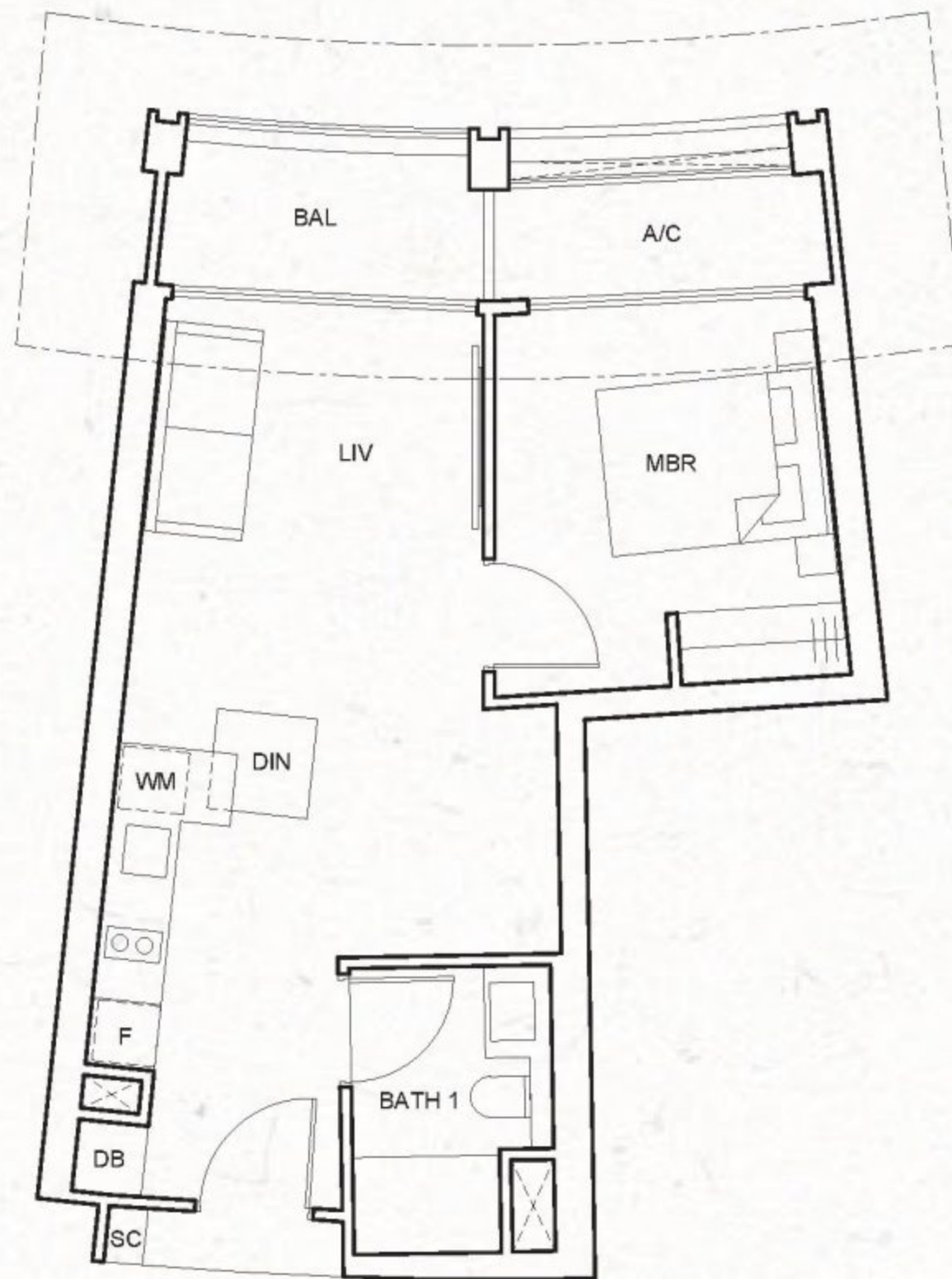

TYPE B1-b
53 sq m / 570 sq ft

#03-09; #04-09; #05-09; #07-09; #08-09;
#09-09; #11-09; #12-09; #13-09; #15-09;
#16-09; #17-09; #20-09; #21-09; #22-09;
#24-09; #25-09; #26-09; #28-09; #29-09;
#30-09; #32-09; #33-09; #34-09; #36-09;
#37-09;

#03-20; #04-20; #05-20; #07-20; #08-20;
#09-20; #11-20; #12-20; #13-20; #16-20;
#17-20; #18-20; #20-20; #21-20; #22-20;
#24-20; #25-20; #26-20; #28-20; #29-20;
#30-20; #32-20; #33-20; #34-20; #36-20;
#37-20;

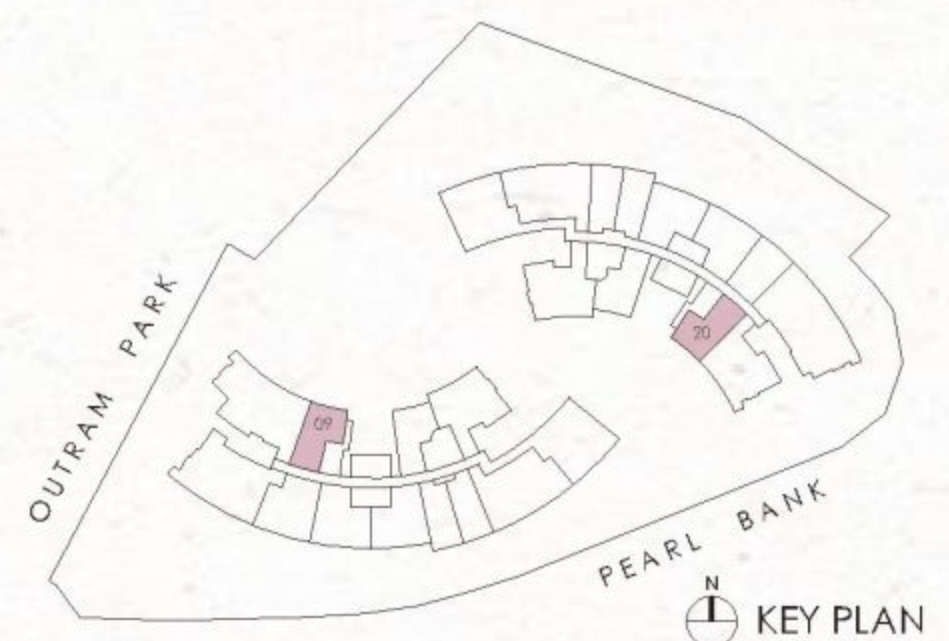
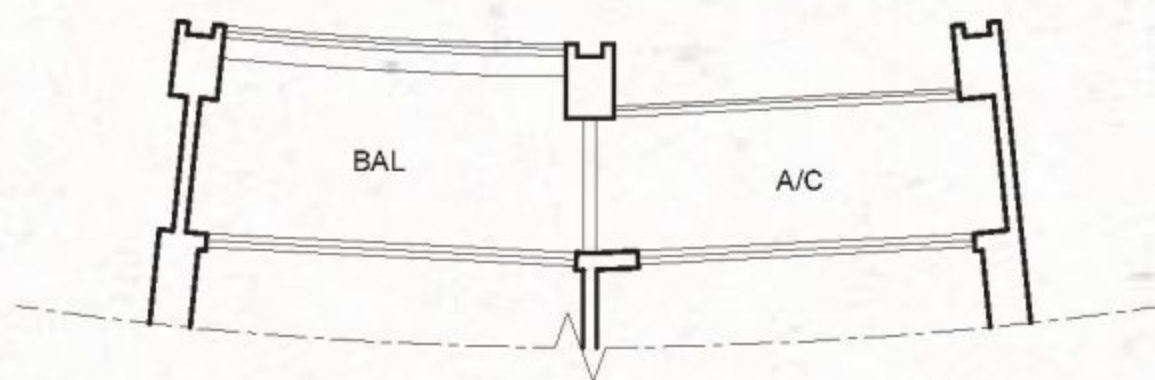

All floor areas indicated are inclusive of AC ledge, planters and balcony where applicable. The plans are subject to change as may be approved by the relevant authorities. All floor plans are approximate measurements only and subject to government re-survey. The balcony shall not be enclosed unless with the approved balcony screen. The installation and cost of the balcony screen shall be borne by the purchaser. For an illustration of the approved balcony screen, please refer to the diagram annexed hereto as "Annexure".

2-BEDROOM

TYPE C1-a
65 sq m / 700 sq ft

#02-04; #06-04; #10-04; #14-04; #19-04;
#23-04; #27-04; #31-04; #35-04;

#02-15; #06-15; #10-15; #15-15; #19-15;
#23-15; #27-15; #31-15; #35-15;

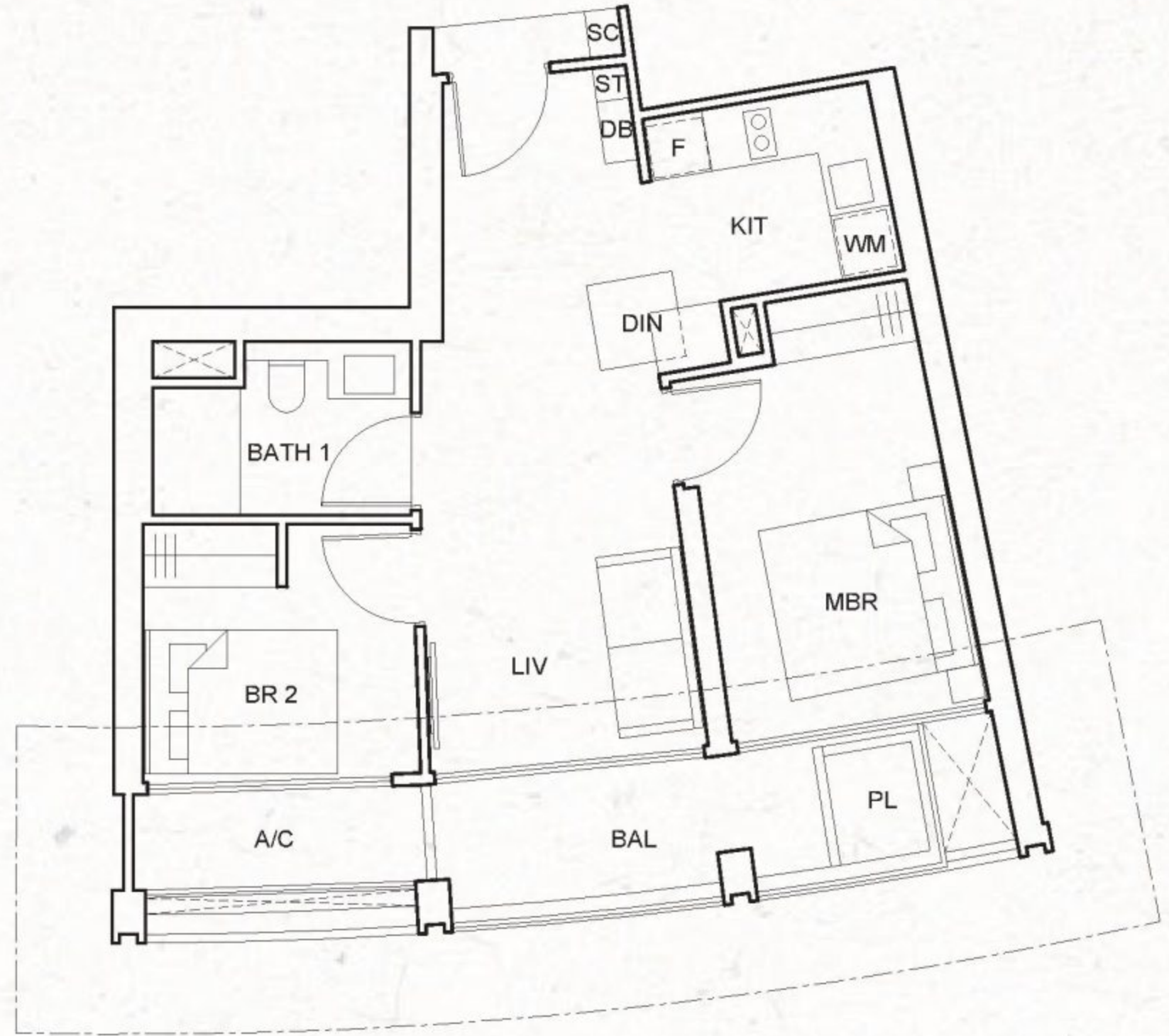

TYPE C1-b
65 sq m / 700 sq ft

#03-04; #05-04; #07-04; #09-04; #11-04;
#13-04; #15-04; #17-04; #20-04; #22-04;
#24-04; #26-04; #28-04; #30-04; #32-04;
#34-04; #36-04;

#03-15; #05-15; #07-15; #09-15; #11-15;
#13-15; #16-15; #18-15; #20-15; #22-15;
#24-15; #26-15; #28-15; #30-15; #32-15;
#34-15; #36-15;

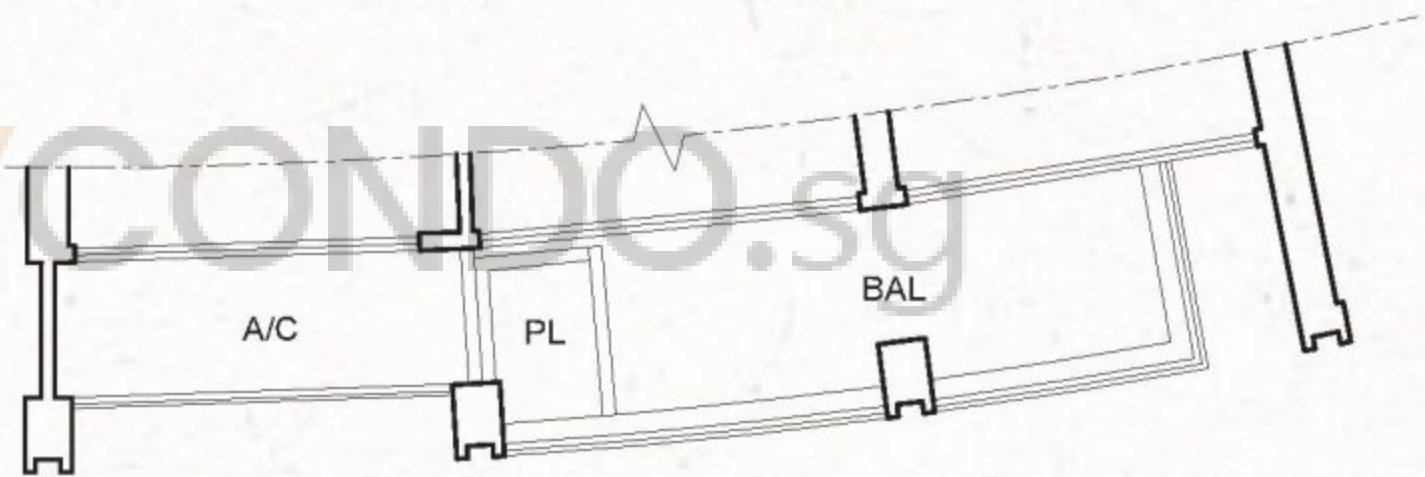

TYPE C1-c
65 sq m / 700 sq ft

#04-04; #08-04; #12-04; #16-04; #21-04;
#25-04; #29-04; #33-04; #37-04;

#04-15; #08-15; #12-15; #17-15; #21-15;
#25-15; #29-15; #33-15; #37-15;

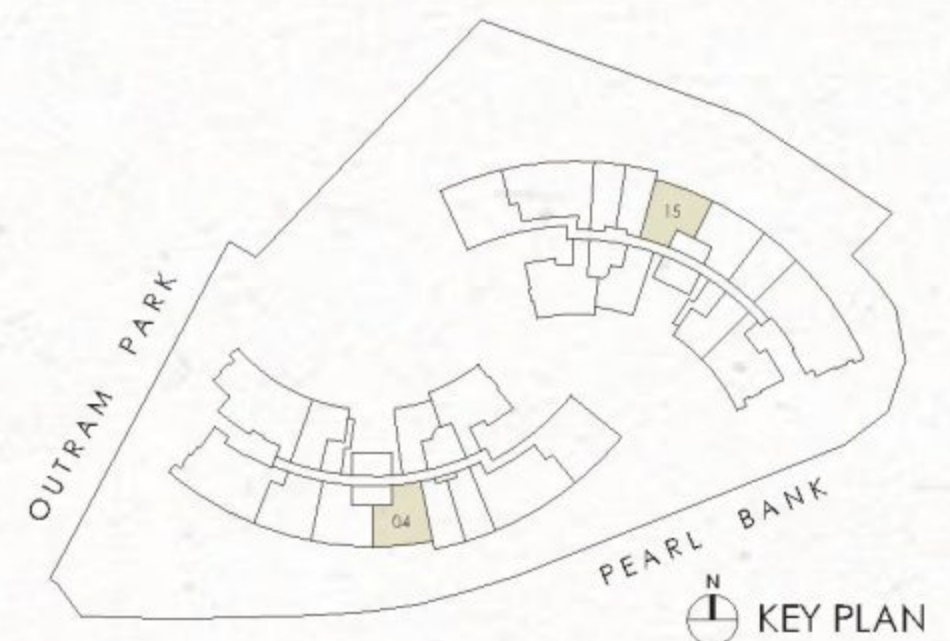
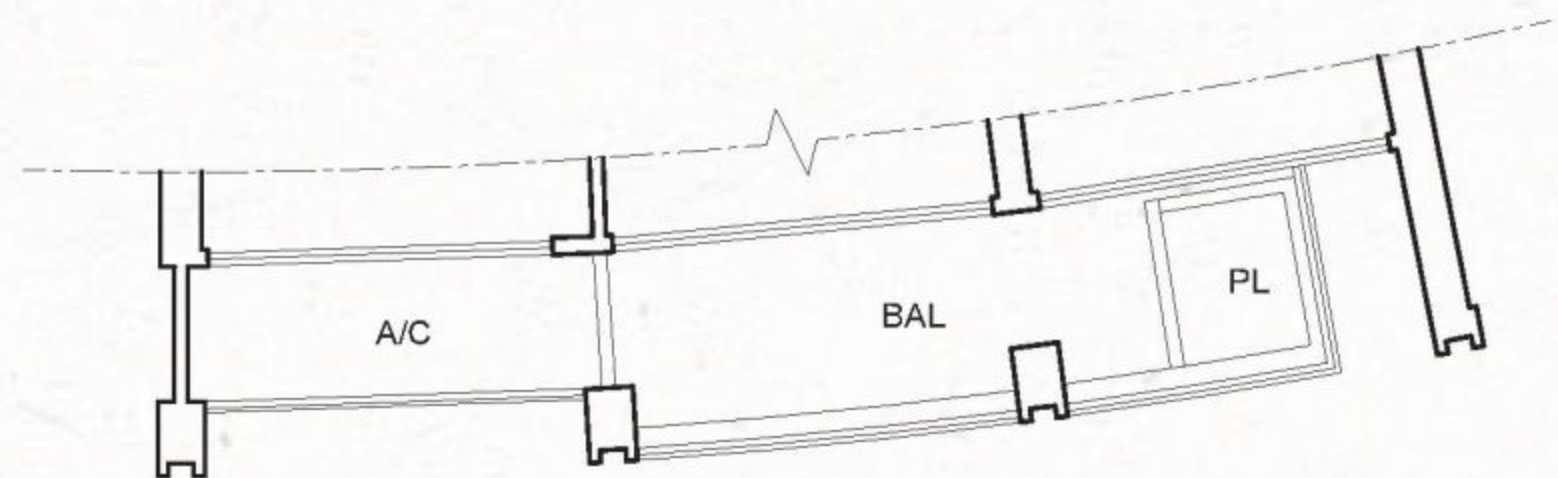

All floor areas indicated are inclusive of AC ledge, planters and balcony where applicable. The plans are subject to change as may be approved by the relevant authorities. All floor plans are approximate measurements only and subject to government re-survey. The balcony shall not be enclosed unless with the approved balcony screen. The installation and cost of the balcony screen shall be borne by the purchaser. For an illustration of the approved balcony screen, please refer to the diagram annexed hereto as "Annexure".

2-BEDROOM

TYPE C4-a
78 sq m / 840 sq ft

#02-19; #06-19; #10-19; #15-19; #19-19;
#23-19; #27-19; #31-19; #35-19

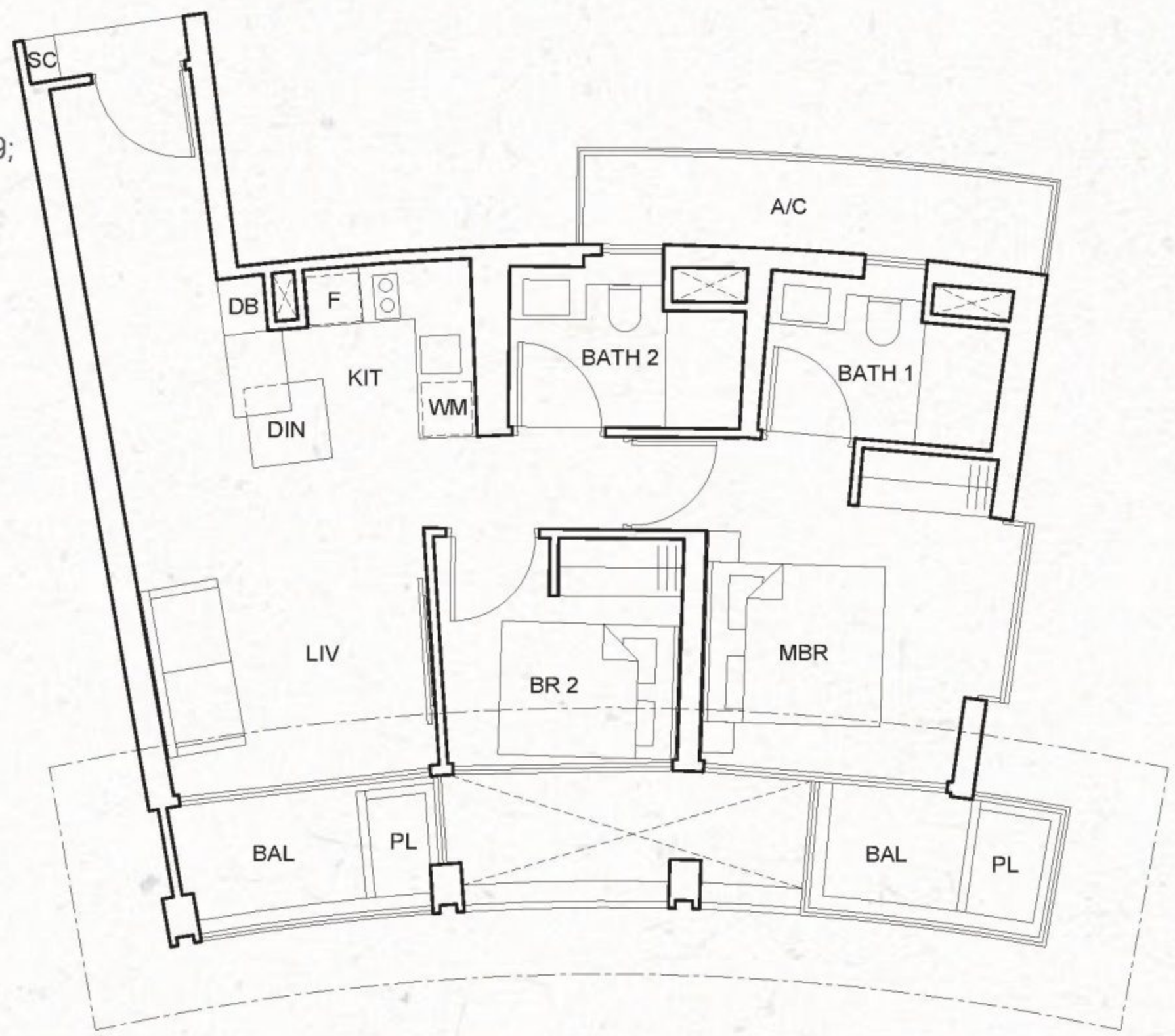

TYPE C4-b
75 sq m / 807 sq ft

#03-19; #05-19; #07-19; #09-19; #11-19;
#13-19; #16-19; #18-19; #20-19; #22-19;
#24-19; #26-19; #28-19; #30-19; #32-19;
#34-19; #36-19

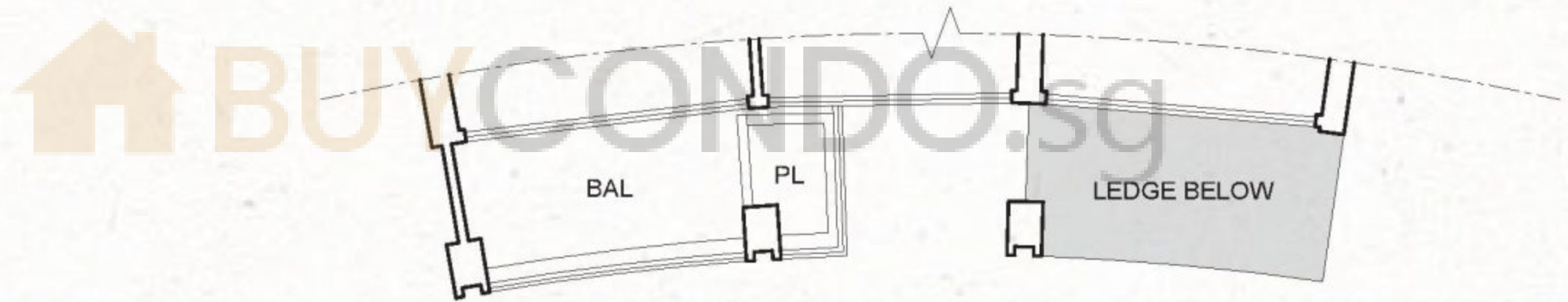

TYPE C4-c
78 sq m / 840 sq ft

#04-19; #08-19; #12-19; #17-19; #21-19;
#25-19; #29-19; #33-19; #37-19

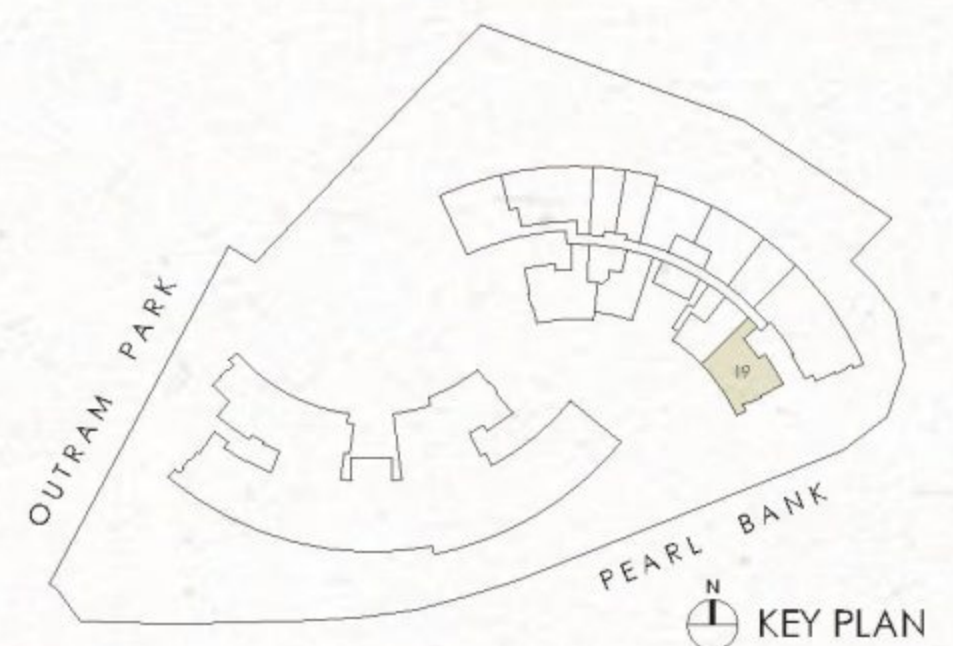
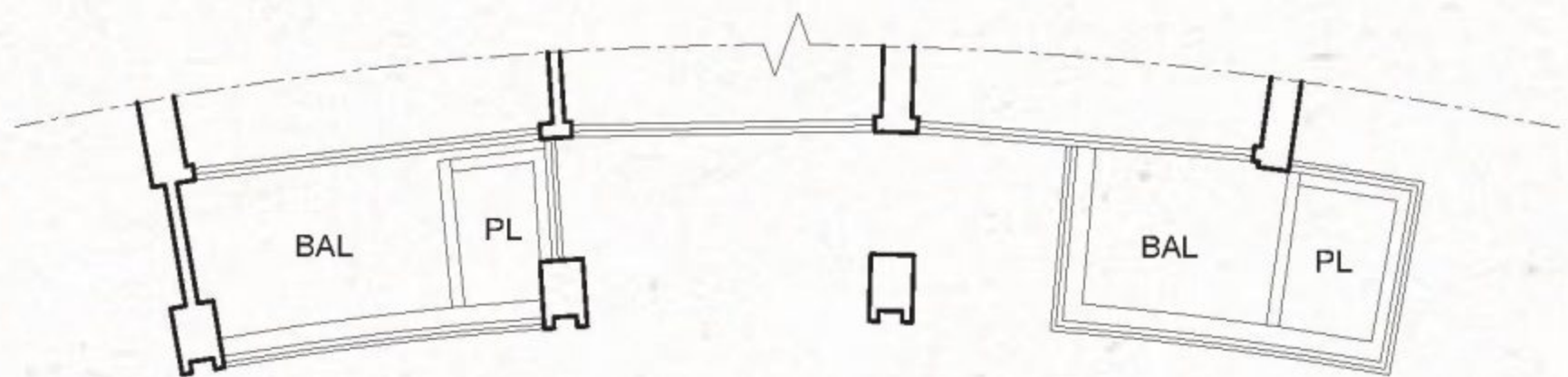

All floor areas indicated are inclusive of AC ledge, planters and balcony where applicable. The plans are subject to change as may be approved by the relevant authorities. All floor plans are approximate measurements only and subject to government re-survey. The balcony shall not be enclosed unless with the approved balcony screen. The installation and cost of the balcony screen shall be borne by the purchaser. For an illustration of the approved balcony screen, please refer to the diagram annexed hereto as "Annexure".

2-BEDROOM

TYPE C1-a (m)
65 sq m / 700 sq ft

#02-05; #06-05; #10-05; #14-05; #19-05;
#23-05; #27-05; #31-05; #35-05;

#02-16; #06-16; #10-16; #15-16; #19-16;
#23-16; #27-16; #31-16; #35-16;

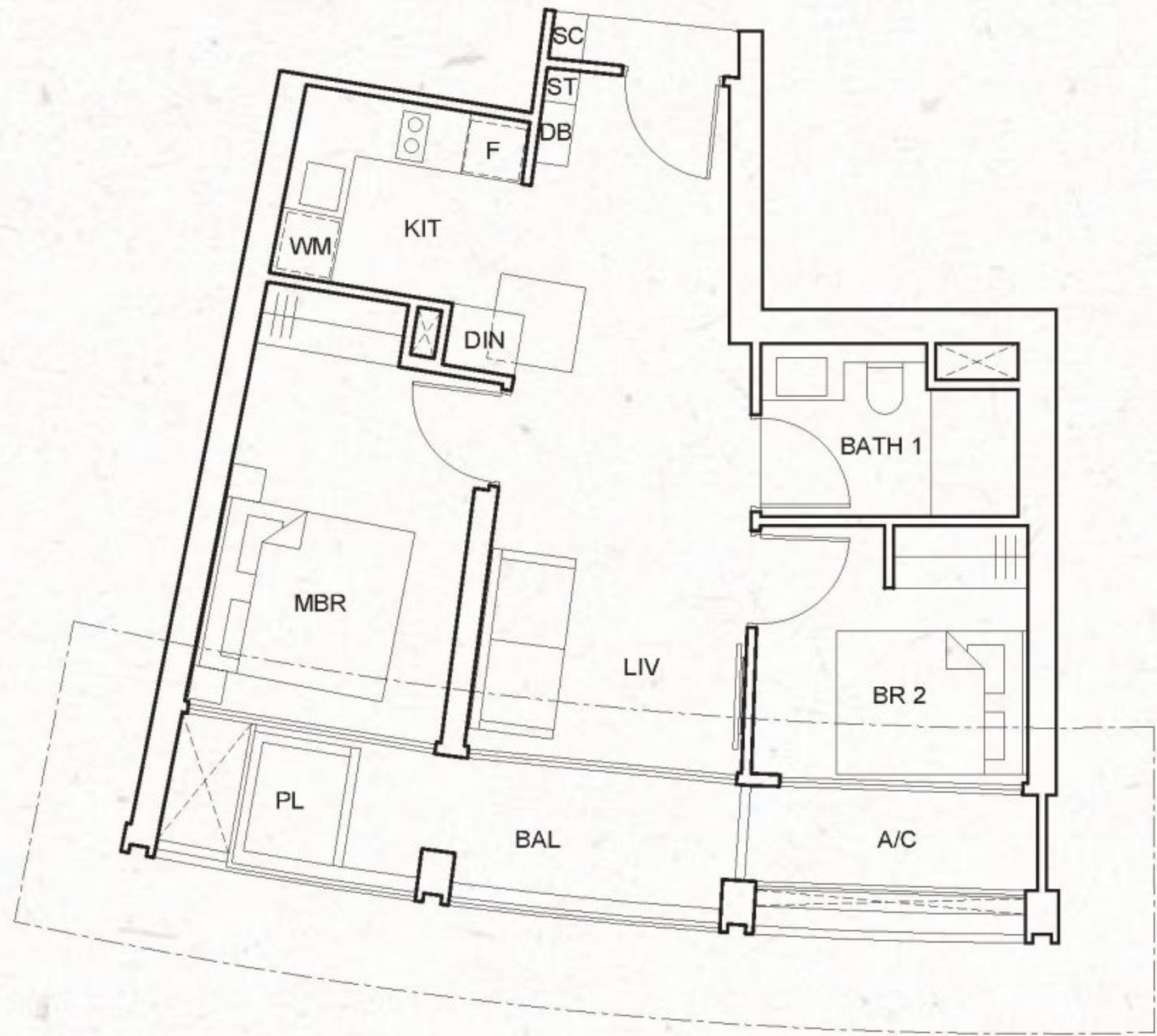

TYPE C1-b (m)
65 sq m / 700 sq ft

#03-05; #05-05; #07-05; #09-05; #11-05;
#13-05; #15-05; #17-05; #20-05; #22-05;
#24-05; #26-05; #28-05; #30-05; #32-05;
#34-05; #36-05;

#03-16; #05-16; #07-16; #09-16; #11-16;
#13-16; #16-16; #18-16; #20-16; #22-16;
#24-16; #26-16; #28-16; #30-16; #32-16;
#34-16; #36-16;

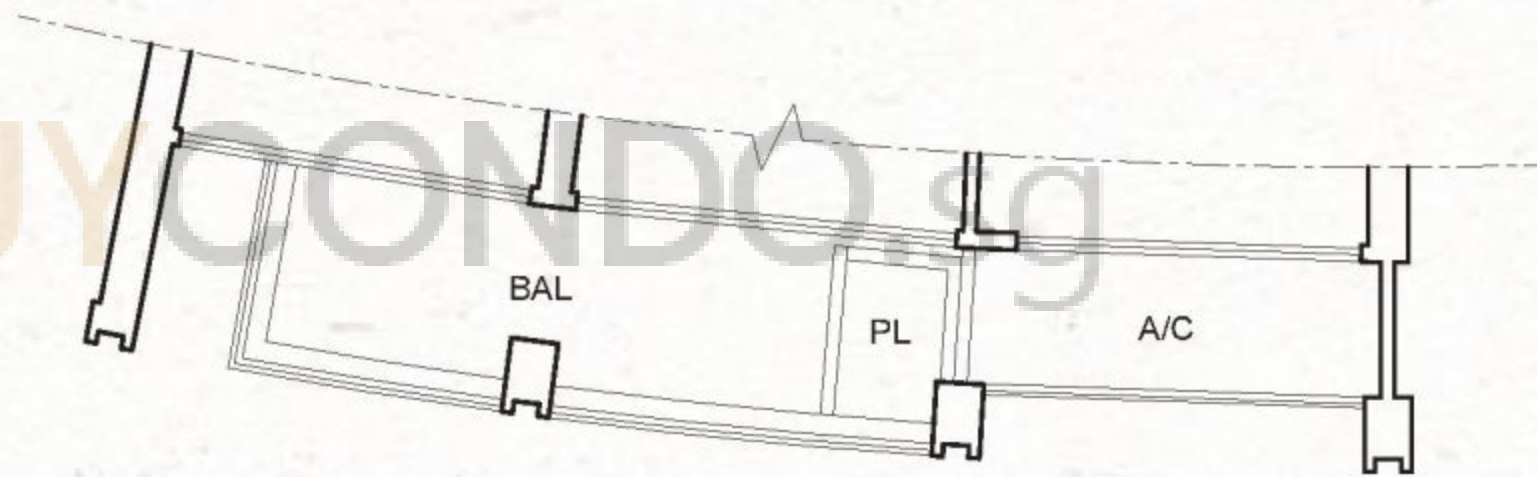

TYPE C1-c (m)
65 sq m / 700 sq ft

#04-05; #08-05; #12-05; #16-05; #21-05;
#25-05; #29-05; #33-05; #37-05;

#04-16; #08-16; #12-16; #17-16; #21-16;
#25-16; #29-16; #33-16; #37-16;

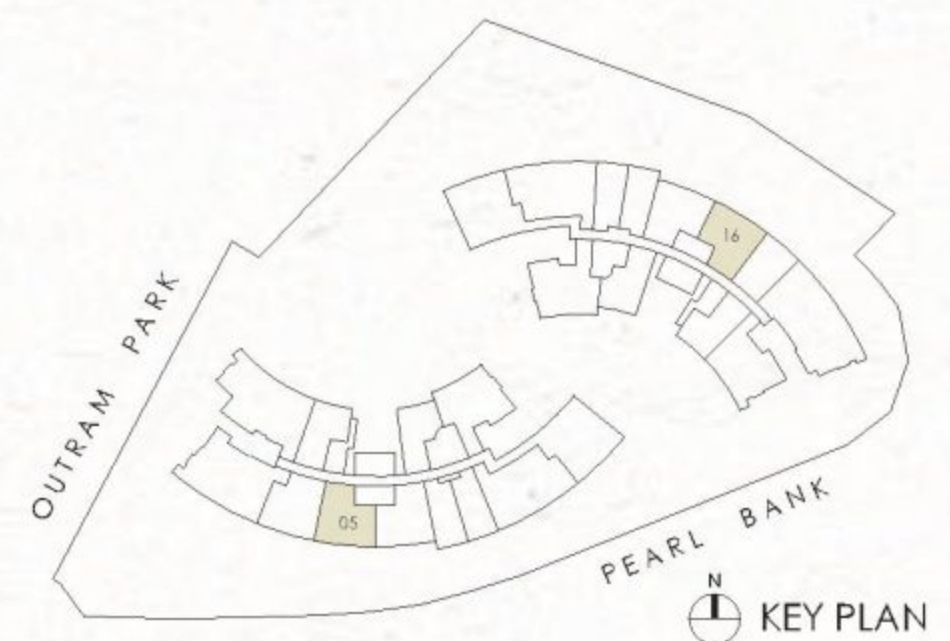
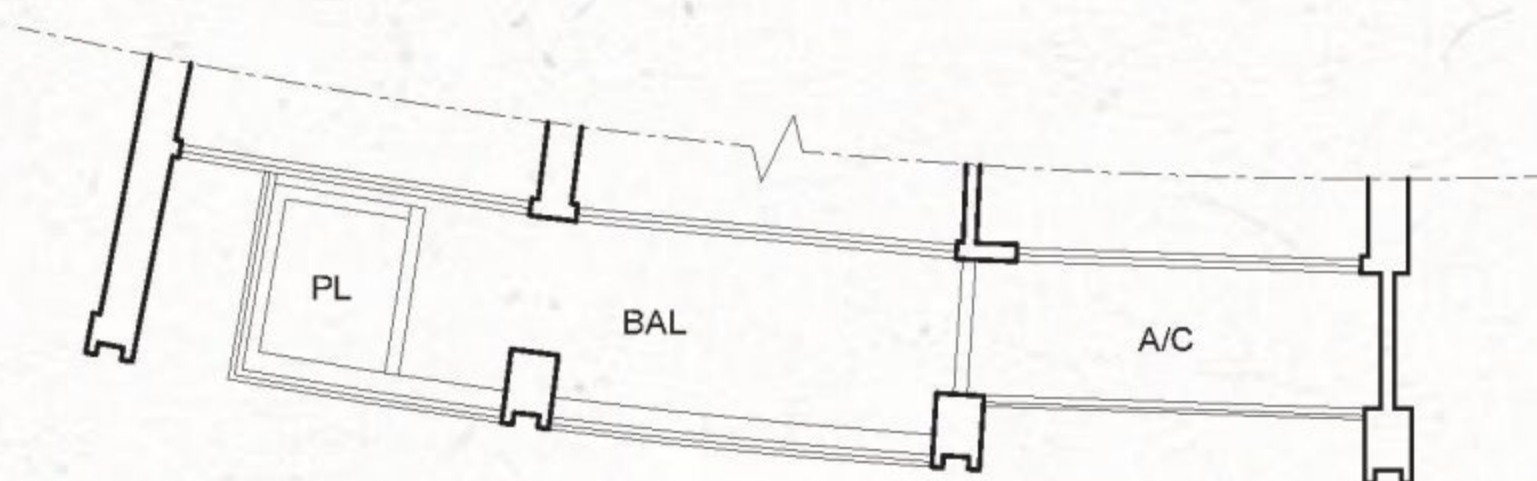

All floor areas indicated are inclusive of AC ledge, planters and balcony where applicable. The plans are subject to change as may be approved by the relevant authorities. All floor plans are approximate measurements only and subject to government re-survey. The balcony shall not be enclosed unless with the approved balcony screen. The installation and cost of the balcony screen shall be borne by the purchaser. For an illustration of the approved balcony screen, please refer to the diagram annexed hereto as "Annexure".

PENTHOUSE

TYPE F1
250 sq m / 2,691 sq ft
#38-18

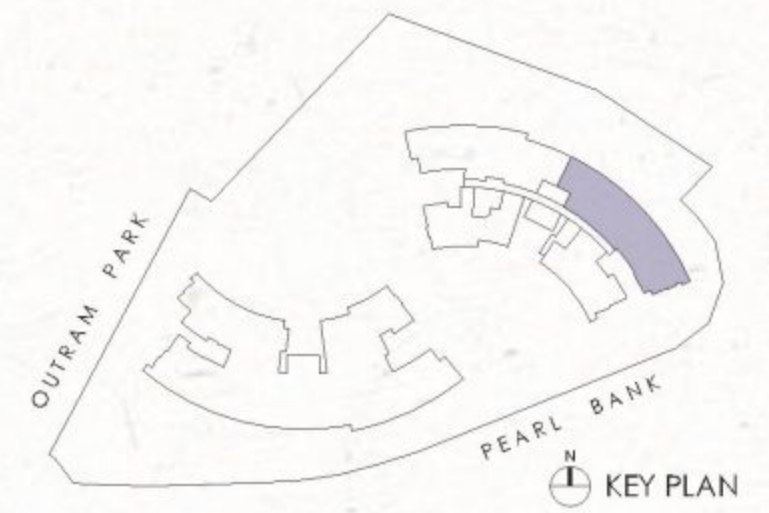

TYPE F2
259 sq m / 2,788 sq ft
#38-13

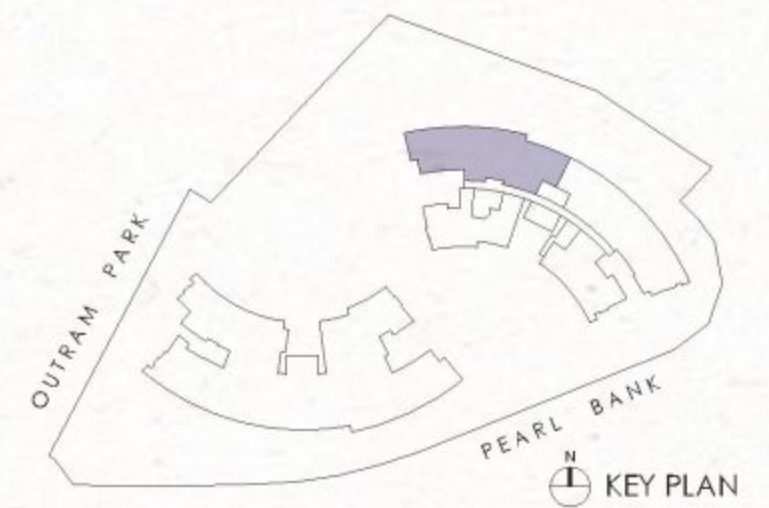
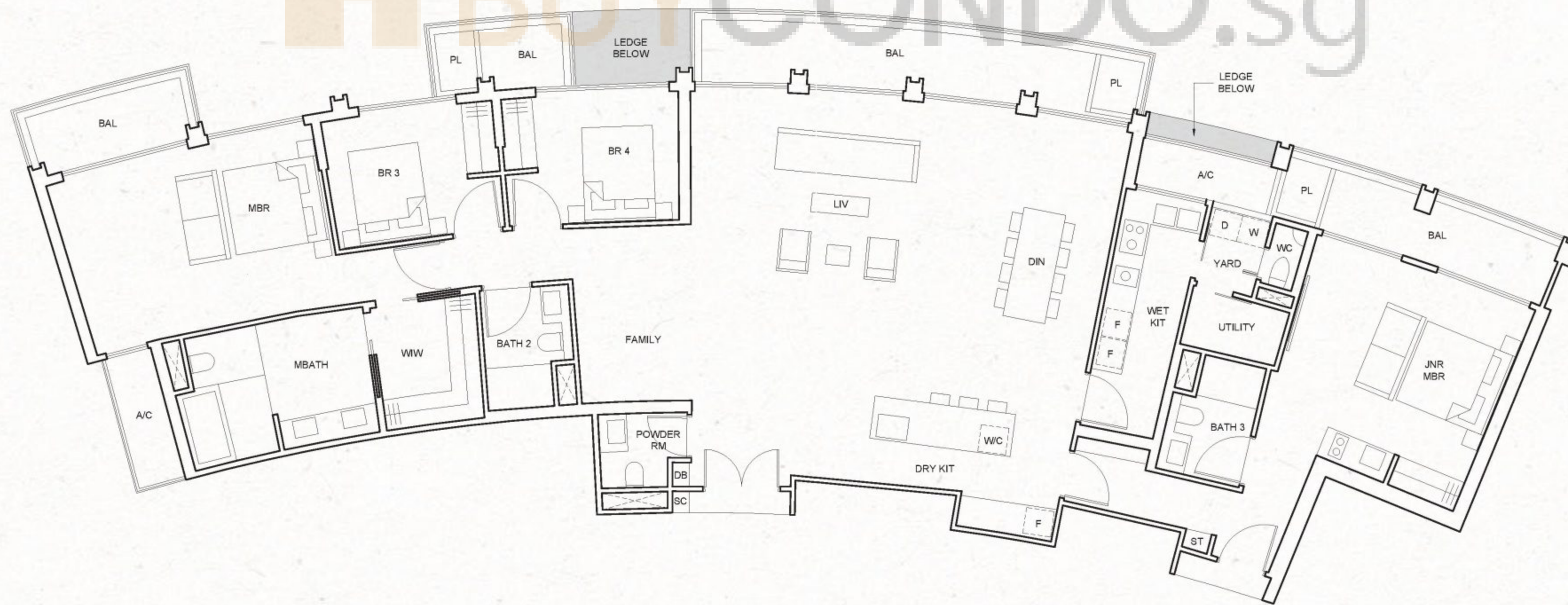

BUYCONDO.sg

All floor areas indicated are inclusive of AC ledge, planters and balcony where applicable. The plans are subject to change as may be approved by the relevant authorities. All floor plans are approximate measurements only and subject to government re-survey. The balcony shall not be enclosed unless with the approved balcony screen. The installation and cost of the balcony screen shall be borne by the purchaser. For an illustration of the approved balcony screen, please refer to the diagram annexed hereto as "Annexure".

TYPE F3
 244 sq m / 2,626 sq ft
 #38-06

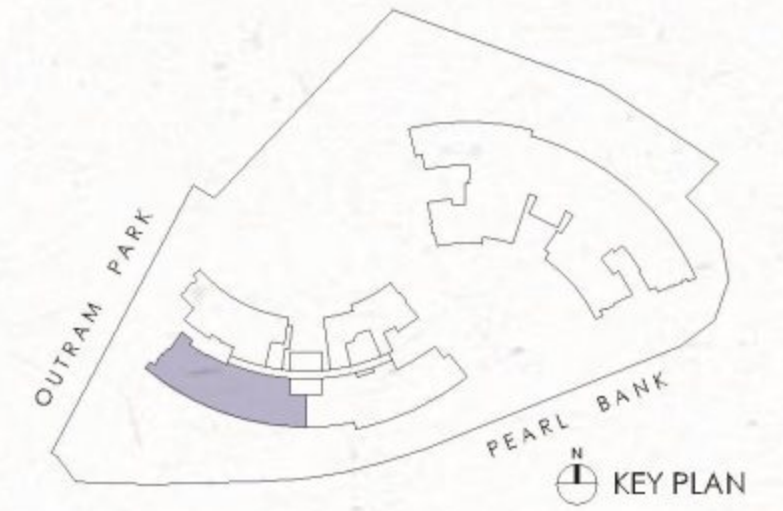
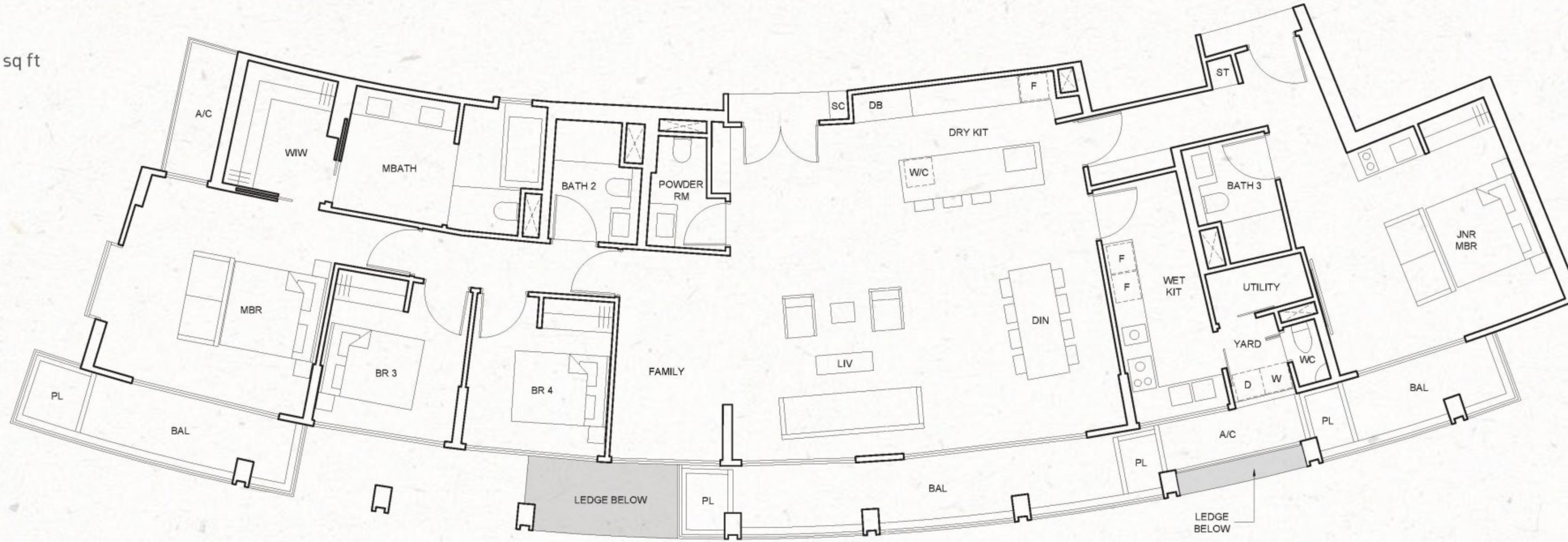

TYPE F4
 258 sq m / 2,777 sq ft
 #38-02

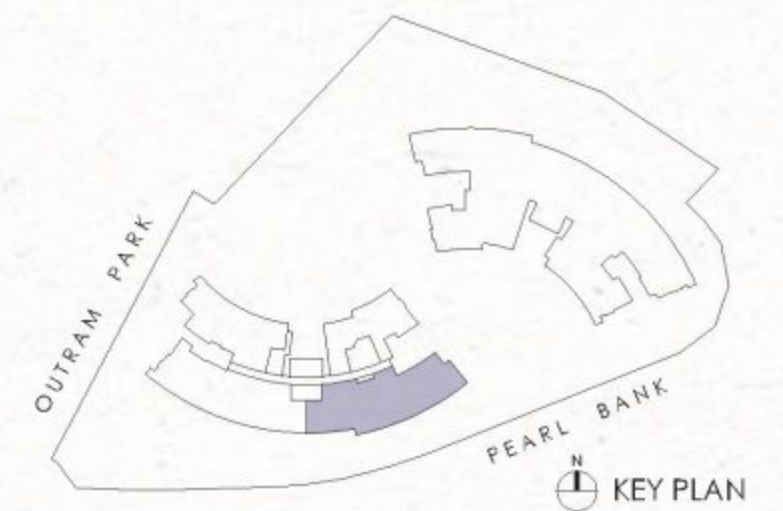
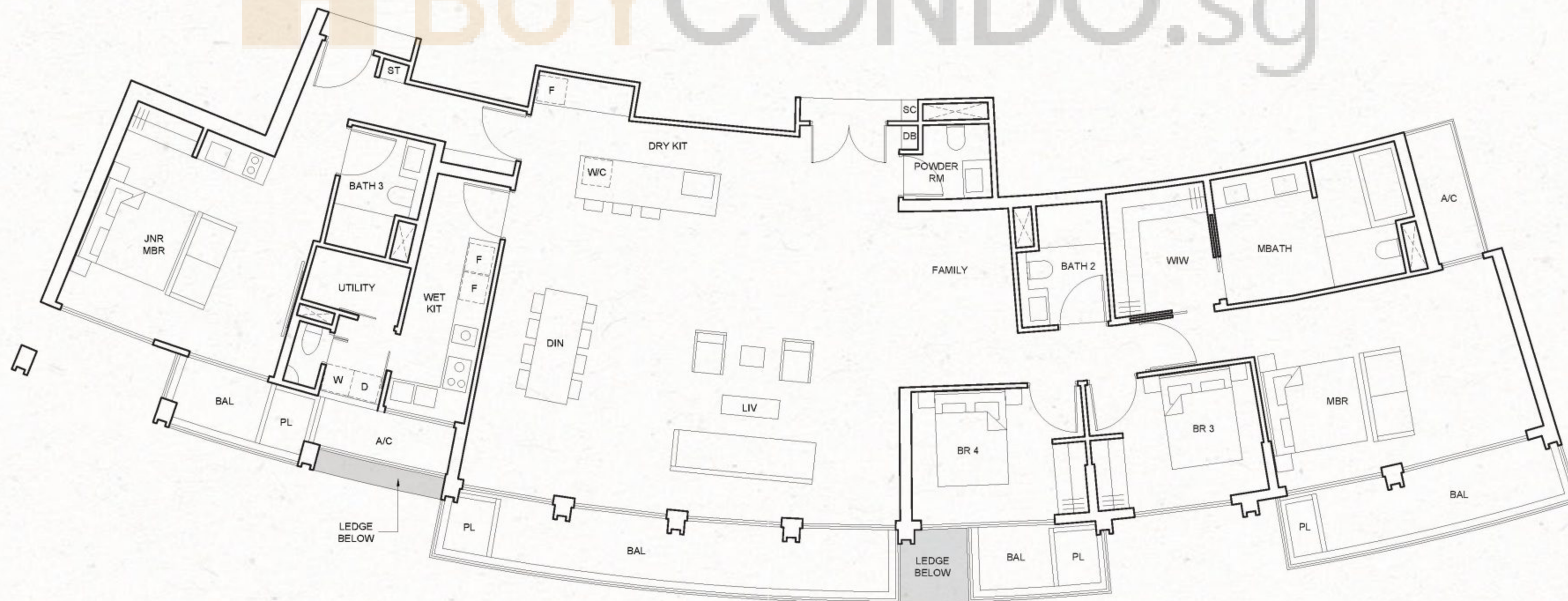

 BUYCONDO.sg

All floor areas indicated are inclusive of AC ledge, planters and balcony where applicable. The plans are subject to change as may be approved by the relevant authorities. All floor plans are approximate measurements only and subject to government re-survey. The balcony shall not be enclosed unless with the approved balcony screen. The installation and cost of the balcony screen shall be borne by the purchaser. For an illustration of the approved balcony screen, please refer to the diagram annexed hereto as "Annexure".