

2ND — 11TH STOREY PLAN
 TYPE A — 2 BEDROOM
 73 sqm / 786 sq ft

Nathan Residences

No.23		No.25	
#02-03	#07-03	#03-06	#07-06
#03-03	#08-03	#04-06	#08-06
#04-03	#09-03	#05-06	#09-06
#05-03	#10-03	#06-06	#10-06
#06-03	#11-03		#11-06

KEYPLAN
No.23

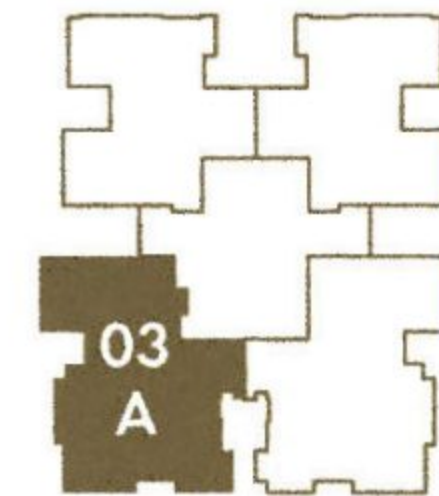

KEYPLAN
No.25

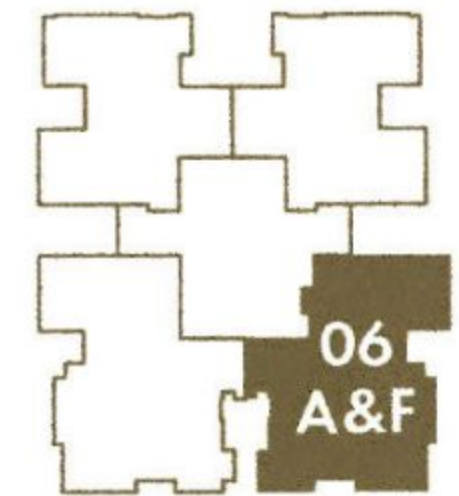

NATHAN ROAD

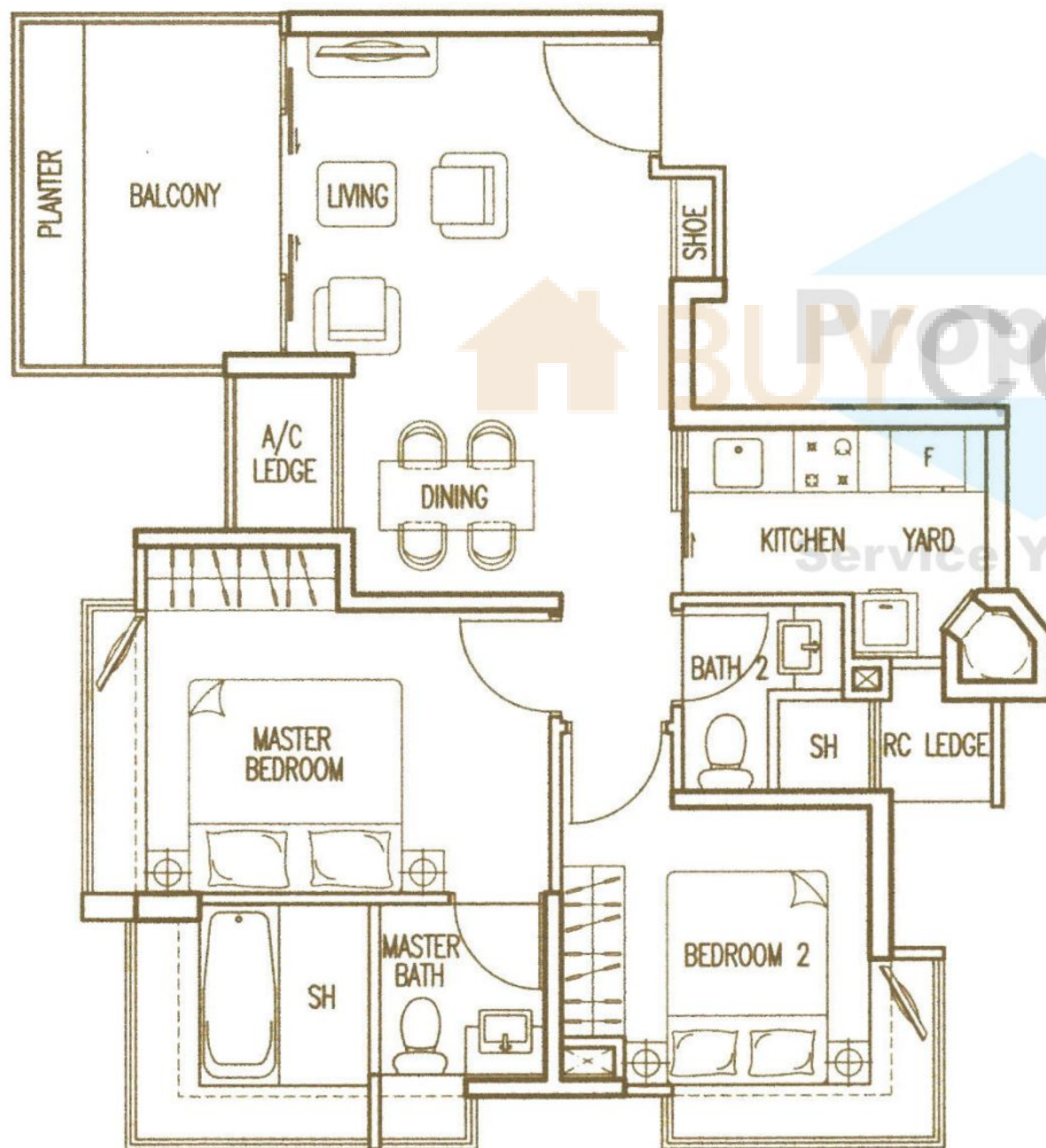

2ND STOREY PLAN
 TYPE F — 2 BEDROOM
 89 sqm / 958 sq ft

No.25
#02-06



1ST STOREY PLAN
TYPE A1 — 2 BEDROOM WITH PES
88 sqm / 947 sq ft

Nathan Residences

No.23
#01-03

KEYPLAN
No.23

KEYPLAN
No.25

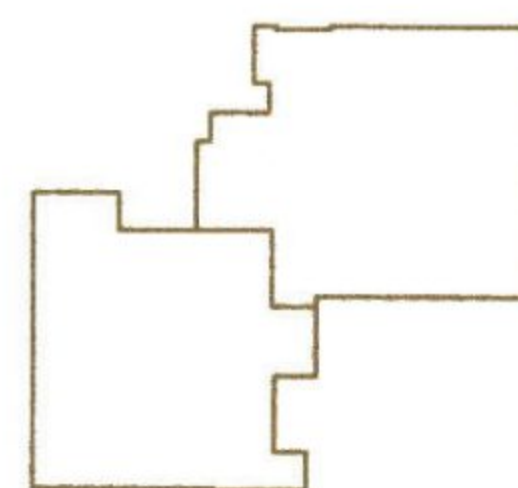

NATHAN ROAD

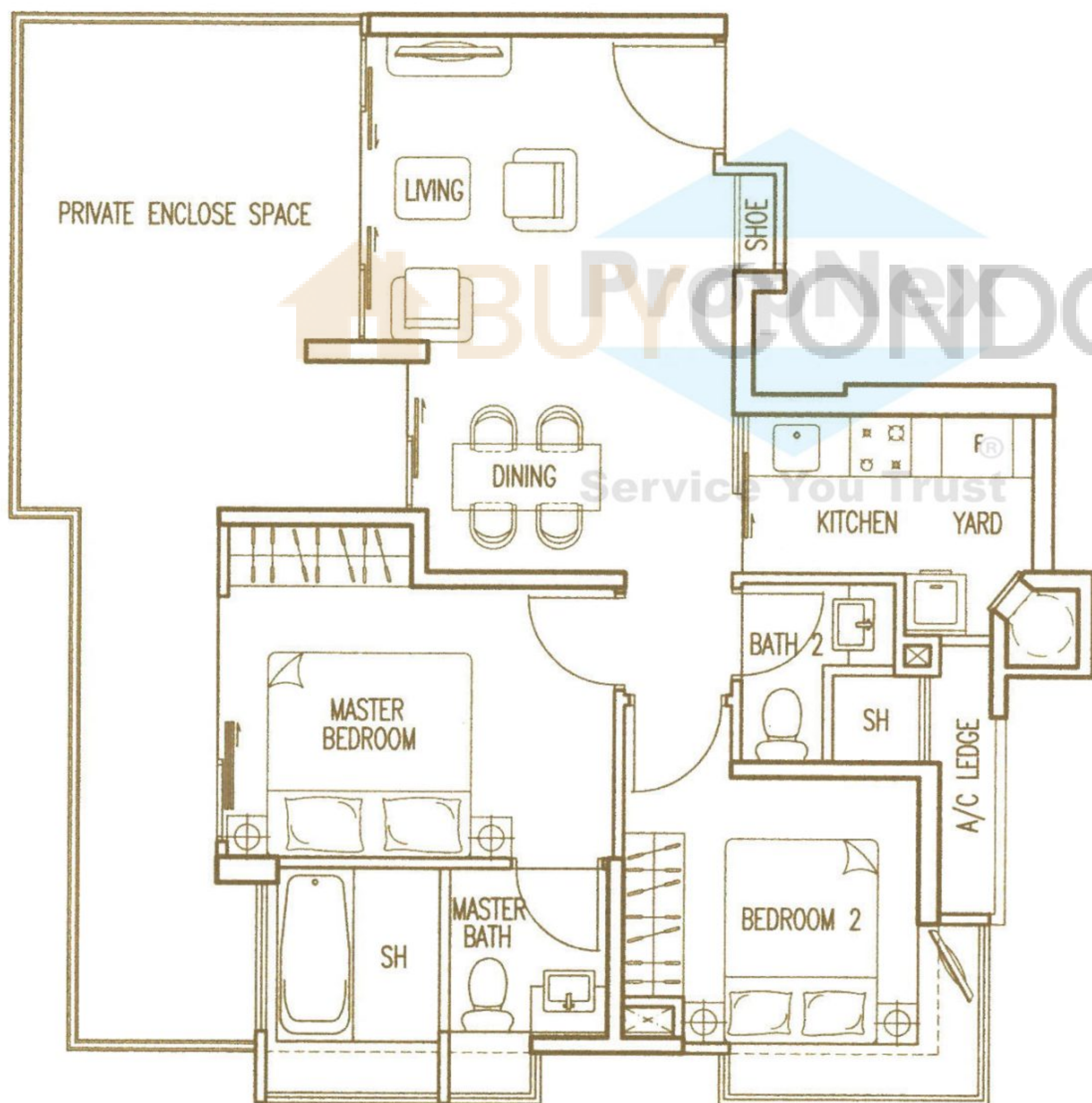

12TH STOREY PLAN
 TYPE A2 — 2 BEDROOM
 WITH OPEN ROOF TERRACE
 115 sqm / 1238 sq ft

Nathan Residences

No.23	No.25
#12-03	#12-06

KEYPLAN
 No.23

KEYPLAN
 No.25

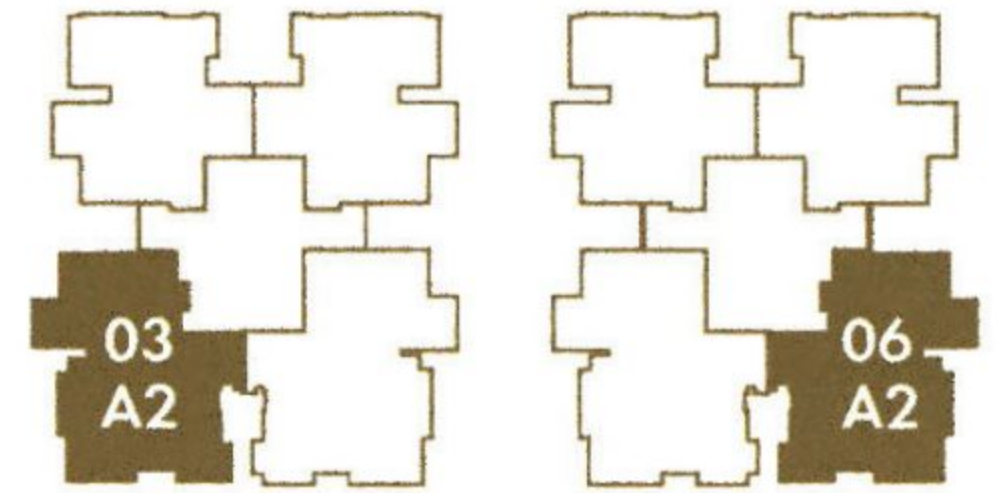

NATHAN ROAD

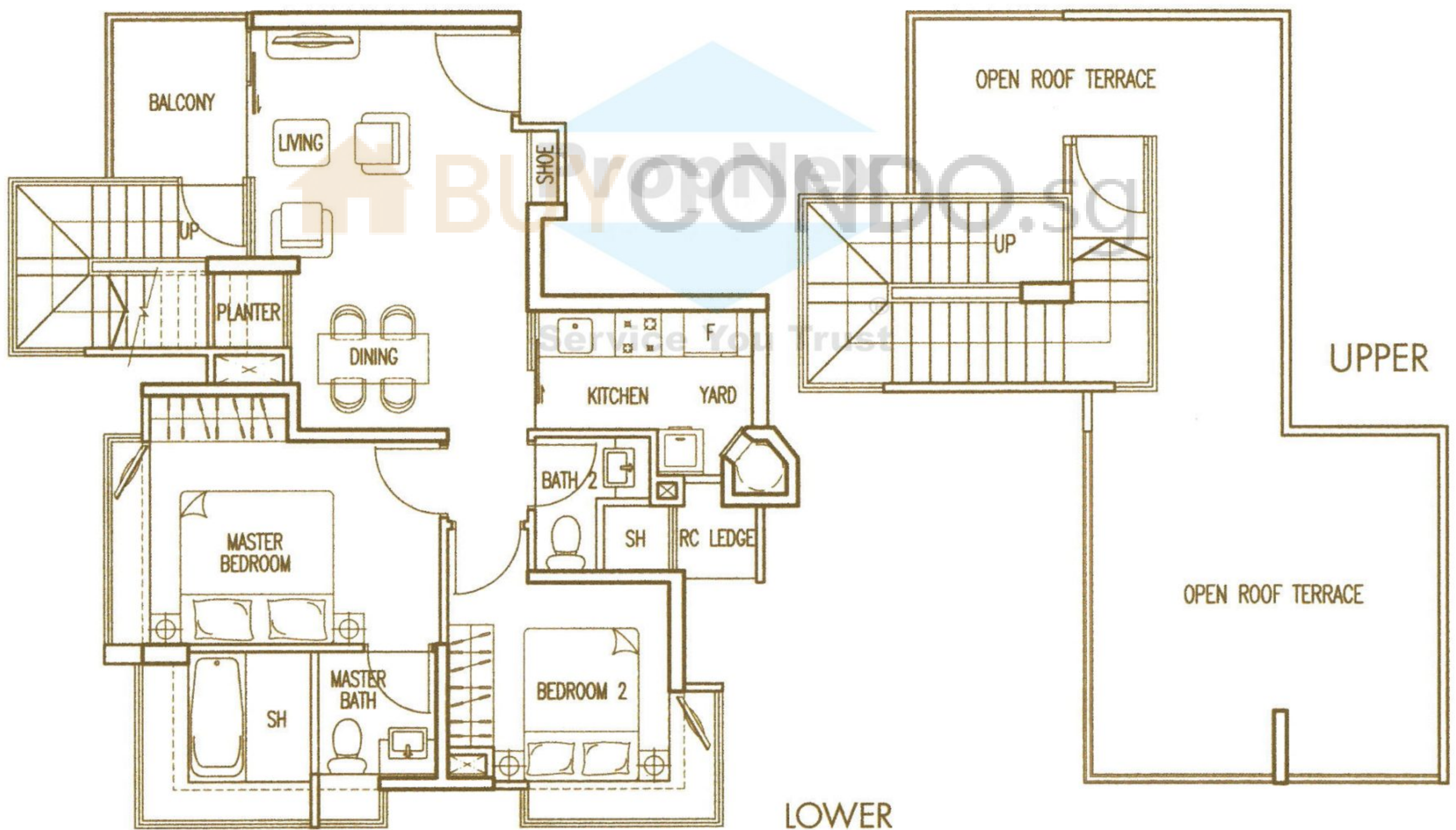

2ND – 11TH STOREY PLAN
 TYPE B – 1 BEDROOM
 55 sqm / 592 sq ft

Nathan Residences

No.23		No.25	
#02-04	#07-04	#02-05	#07-05
#03-04	#08-04	#03-05	#08-05
#04-04	#09-04	#04-05	#09-05
#05-04	#10-04	#05-05	#10-05
#06-04	#11-04	#06-05	#11-05

KEYPLAN
No.23

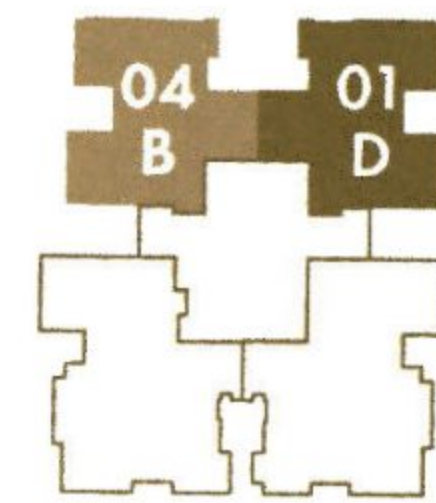

KEYPLAN
No.25

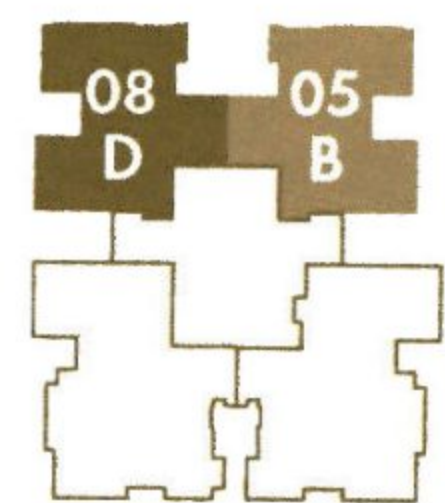

NATHAN ROAD

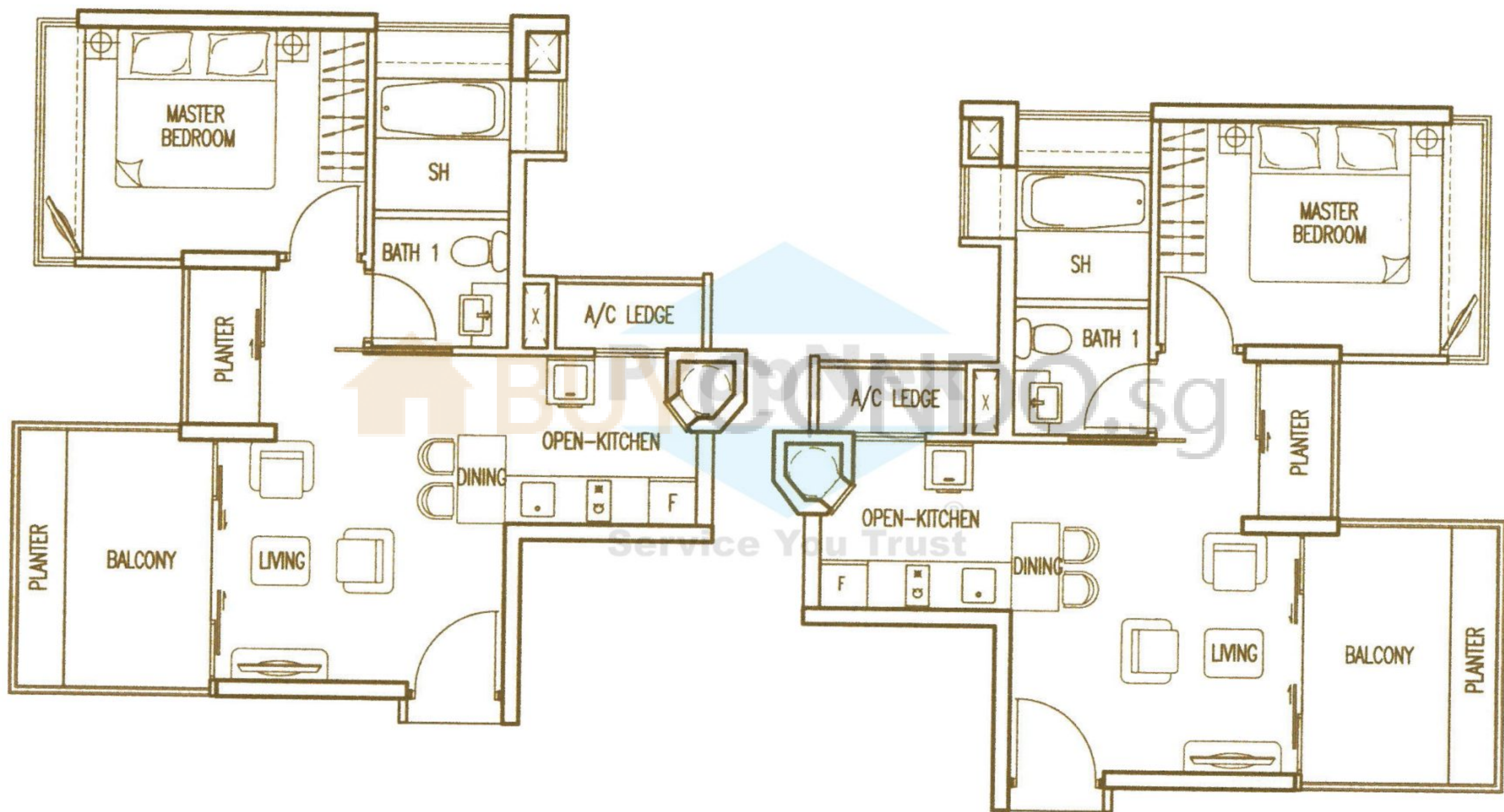

2ND – 11TH STOREY PLAN
 TYPE D – 1 BEDROOM
 55 sqm / 592 sq ft

No.23		No.25	
#02-01	#07-01	#02-08	#07-08
#03-01	#08-01	#03-08	#08-08
#04-01	#09-01	#04-08	#09-08
#05-01	#10-01	#05-08	#10-08
#06-01	#11-01	#06-08	#11-08



1ST STOREY PLAN
TYPE B1 — 1 BEDROOM WITH PES
80 sqm / 861 sq ft

Nathan Residences

No.23
#01-04

KEYPLAN
No.23

KEYPLAN
No.25

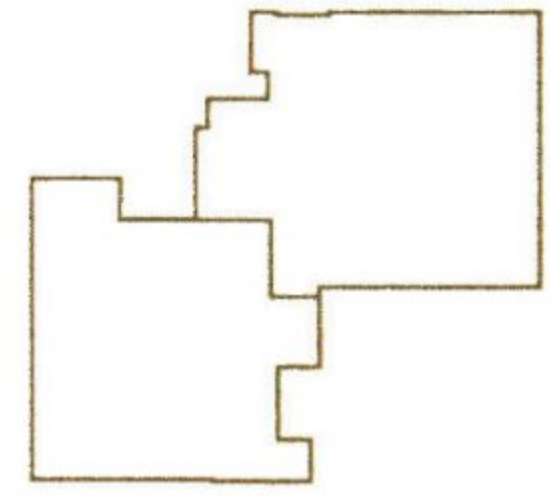
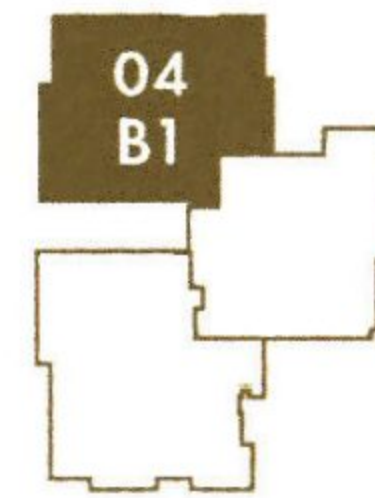

NATHAN ROAD

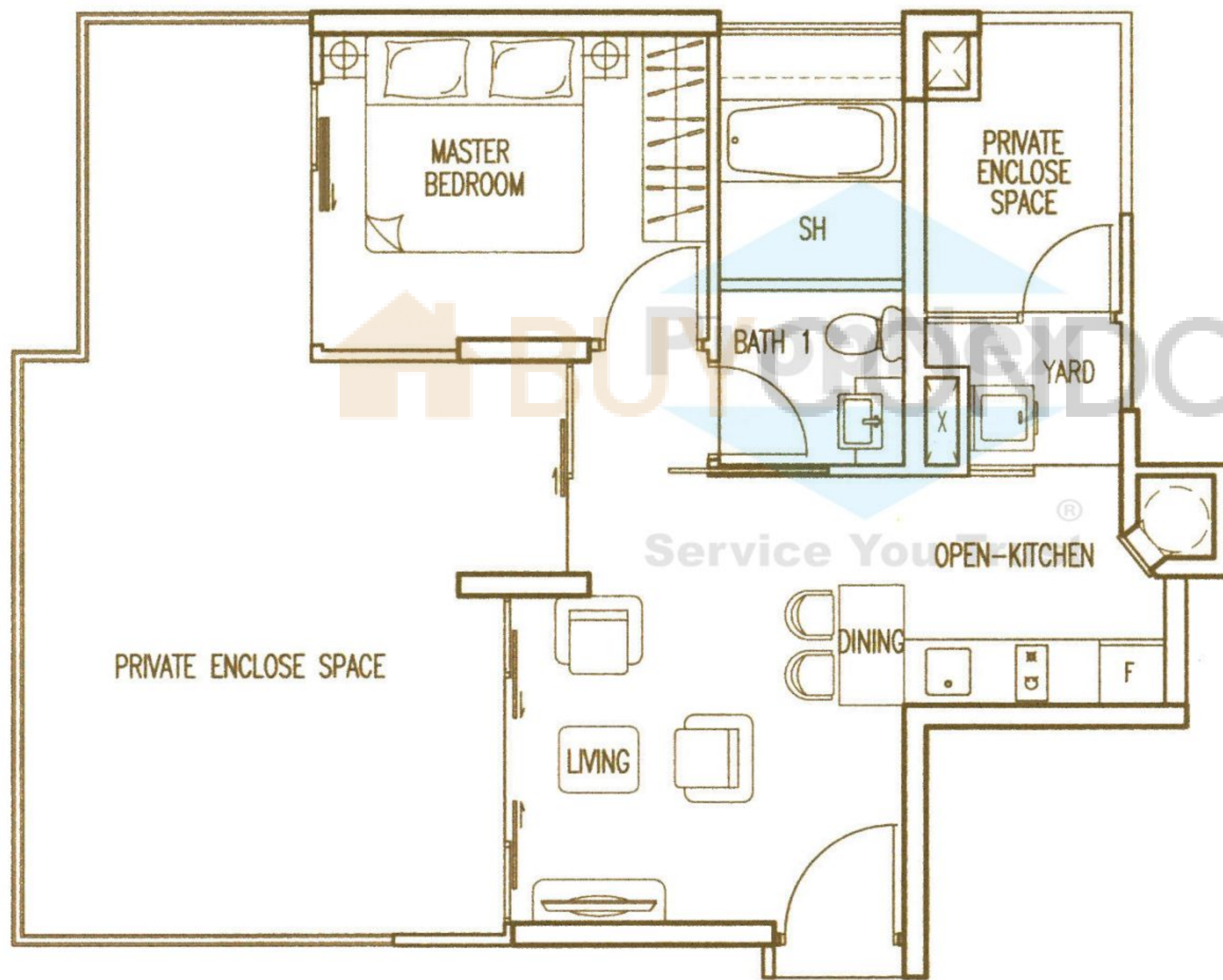

12TH STOREY PLAN
 TYPE B2 — 1 BEDROOM
 WITH OPEN ROOF TERRACE
 94 sqm / 1012 sq ft

No.23	No.25
#12-04	#12-05

Nathan Residences

KEYPLAN
 No.23

KEYPLAN
 No.25

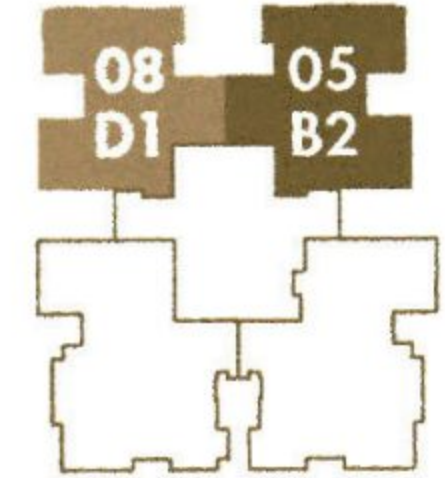
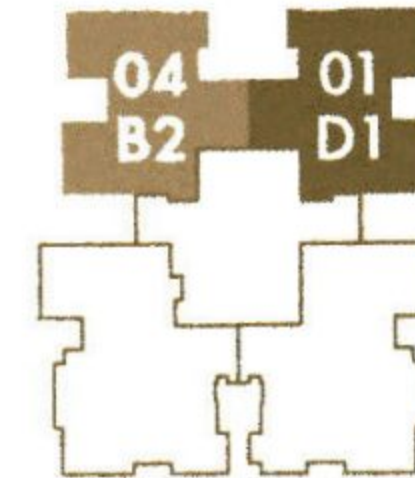

NATHAN ROAD

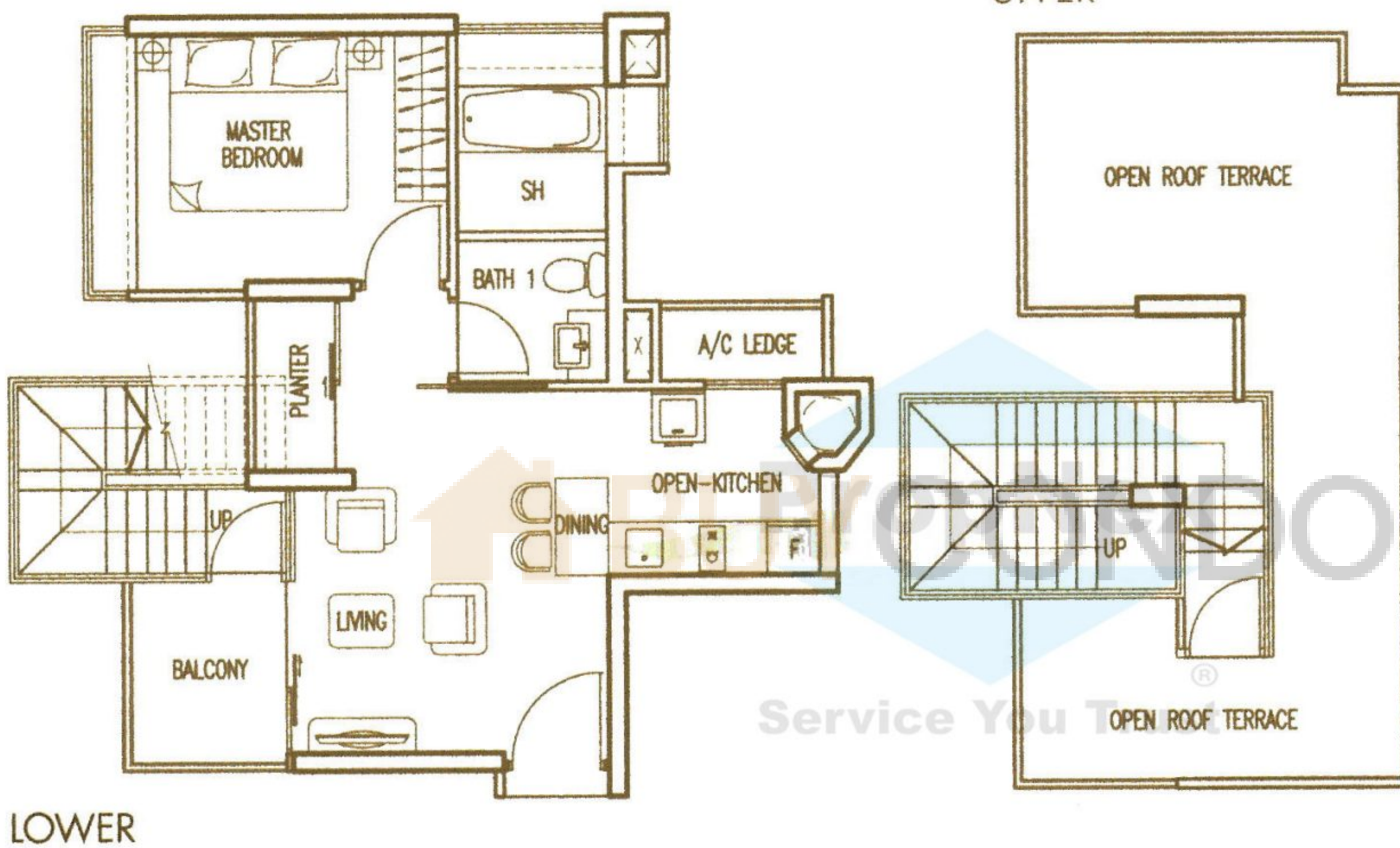

LOWER

12TH STOREY PLAN
 TYPE D1 — 1 BEDROOM
 WITH OPEN ROOF TERRACE
 94 sqm / 1012 sq ft

No.23	No.25
#12-01	#12-08

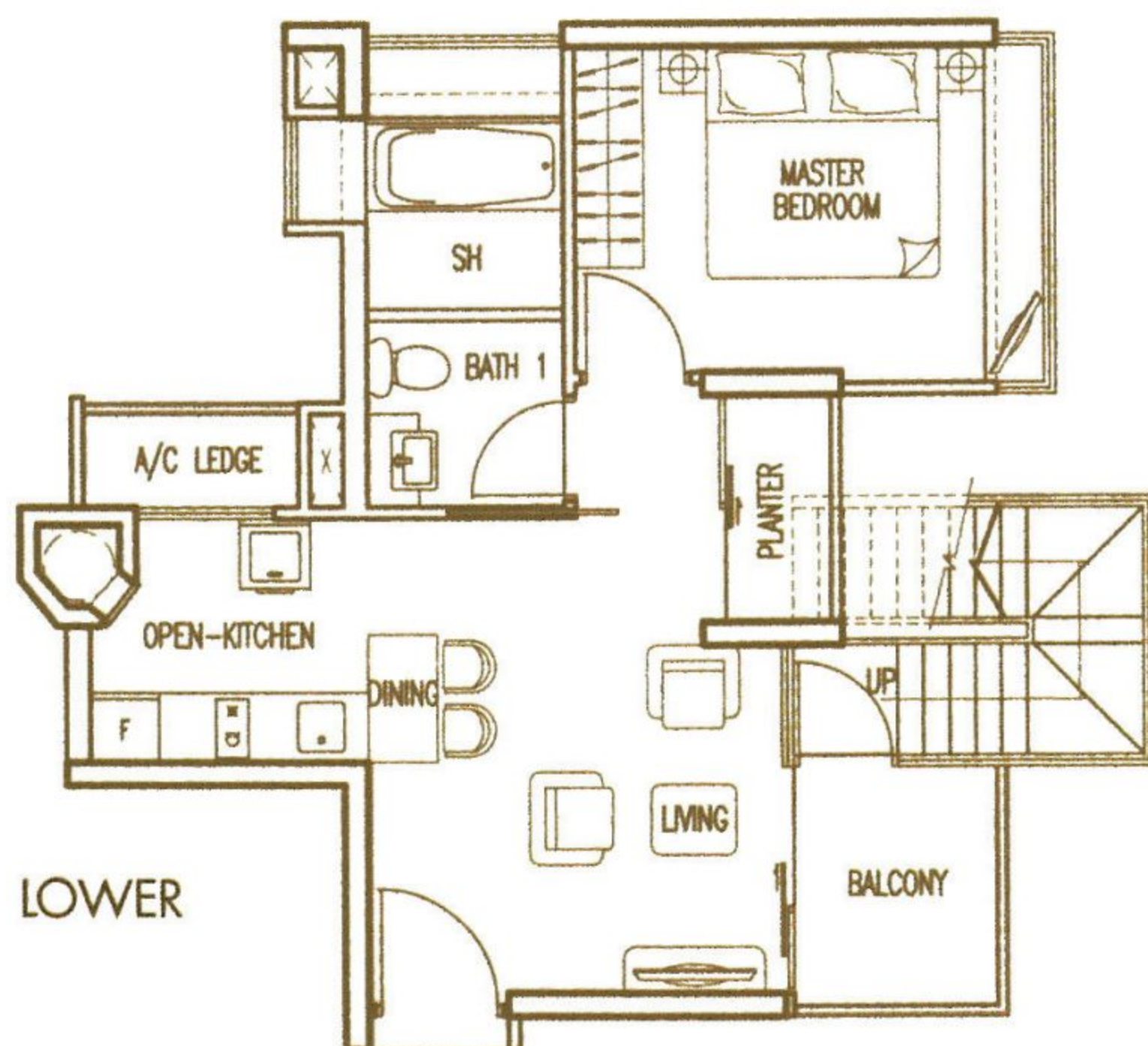

LOWER

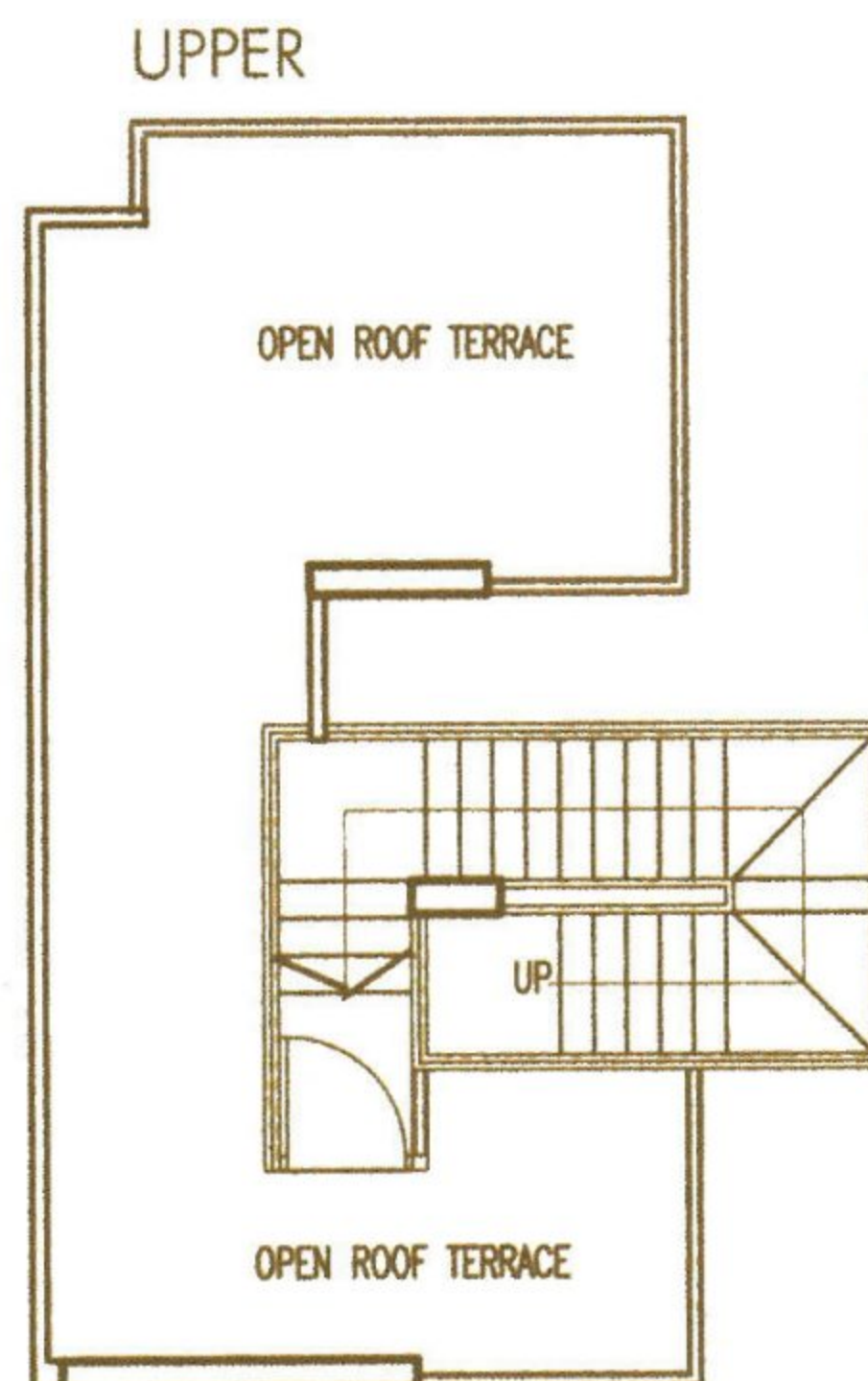

UPPER



2ND – 11TH STOREY PLAN
 TYPE C — 2 BEDROOM
 73 sqm / 786 sq ft

Nathan Residences

No.23		No.25	
#03-02	#07-02	#02-07	#07-07
#04-02	#08-02	#03-07	#08-07
#05-02	#09-02	#04-07	#09-07
#06-02	#10-02	#05-07	#10-07
	#11-02	#06-07	#11-07

KEYPLAN
 No.23

KEYPLAN
 No.25

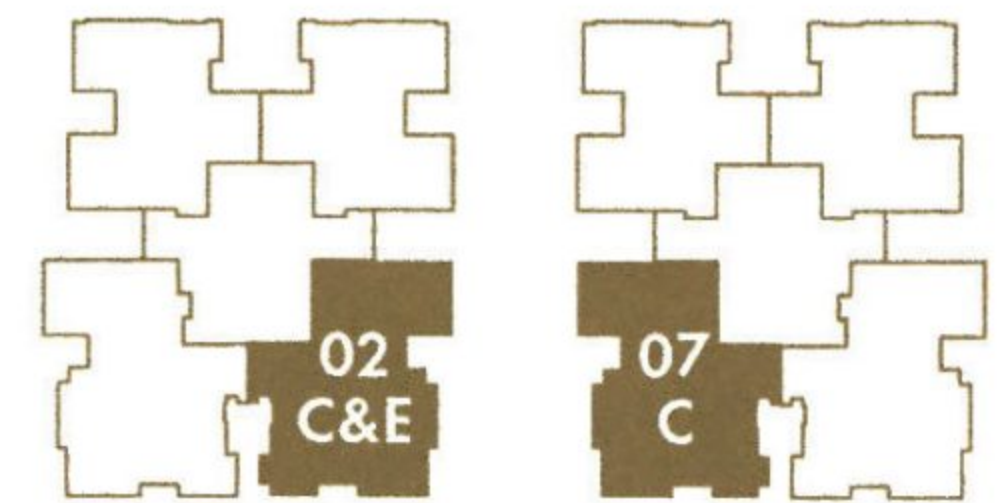

NATHAN ROAD

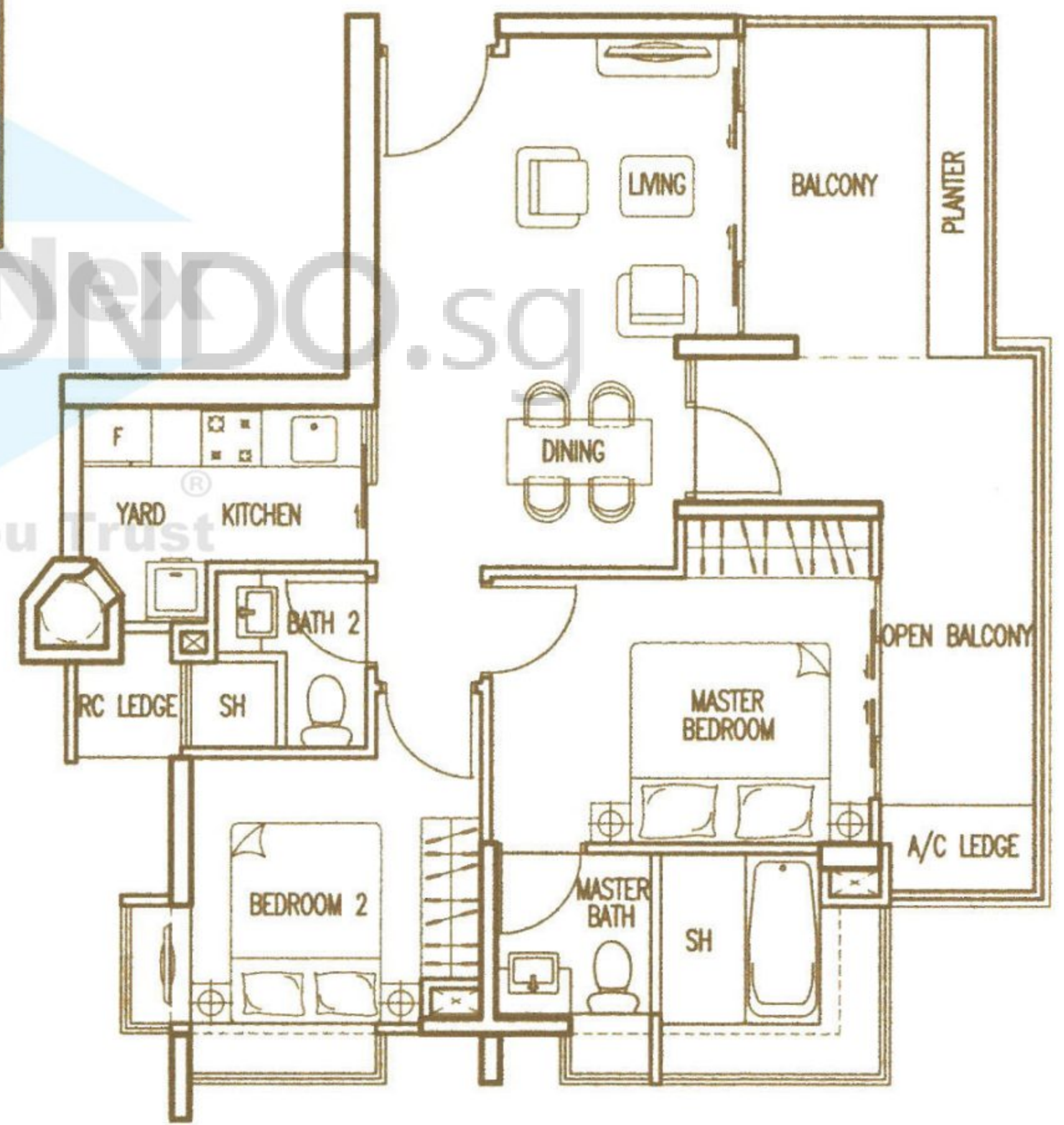
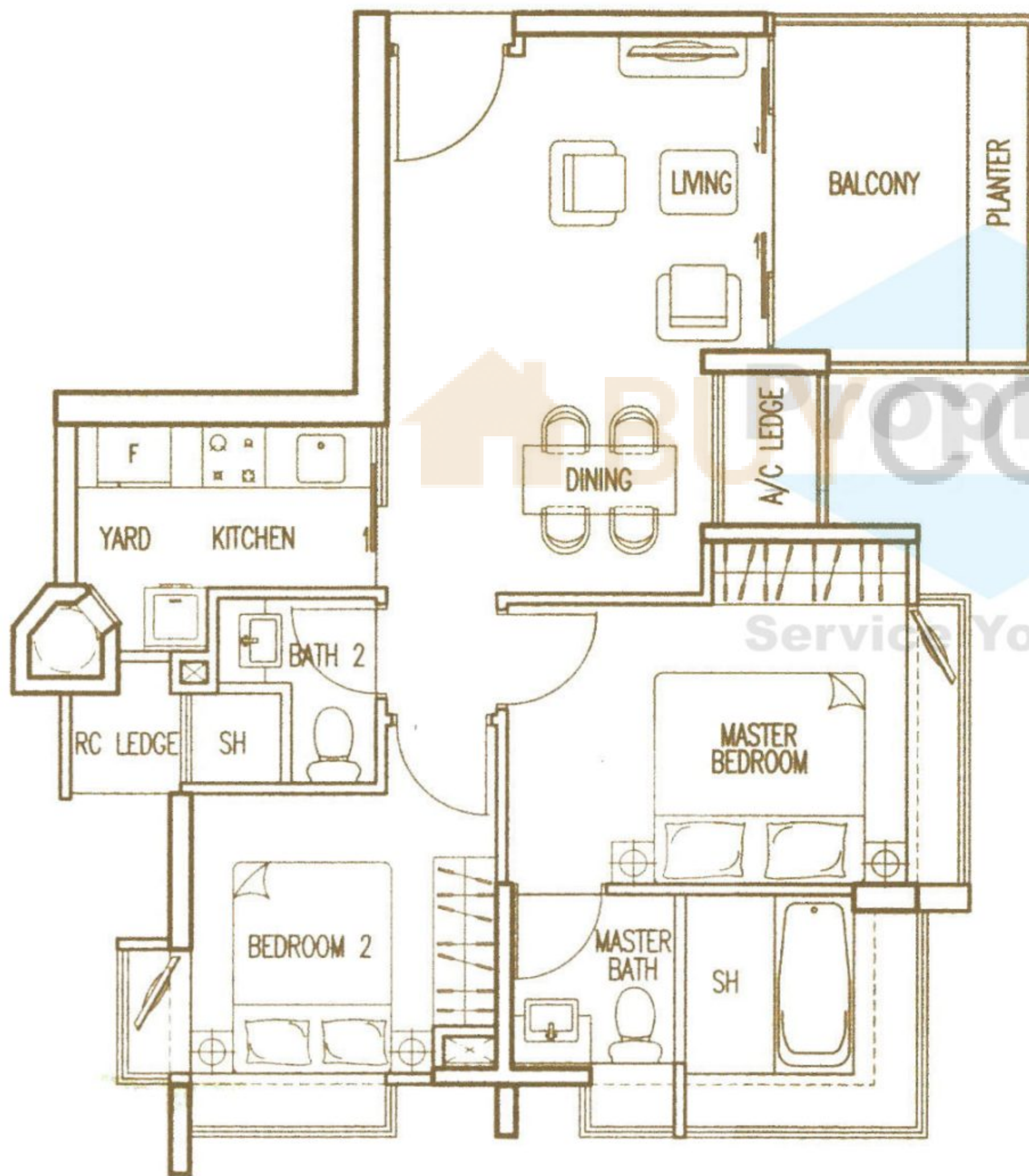

2ND STOREY PLAN
 TYPE E — 2 BEDROOM
 80 sqm / 861 sq ft

No.23
#02-02



12TH STOREY PLAN
 TYPE C1 — 2 BEDROOM
 WITH OPEN ROOF TERRACE
 114 sqm / 1227 sq ft

Nathan Residences

No.23	No.25
#12-02	#12-07

KEYPLAN
 No.23

KEYPLAN
 No.25

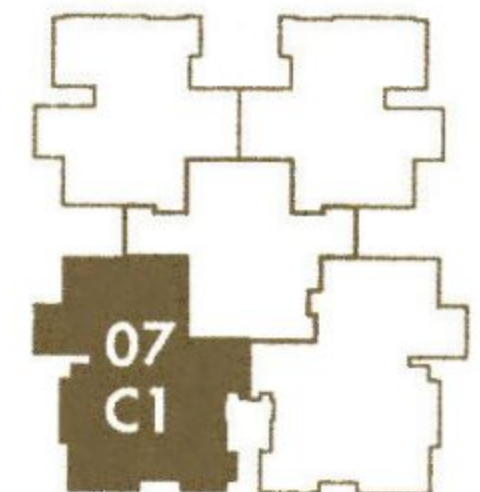
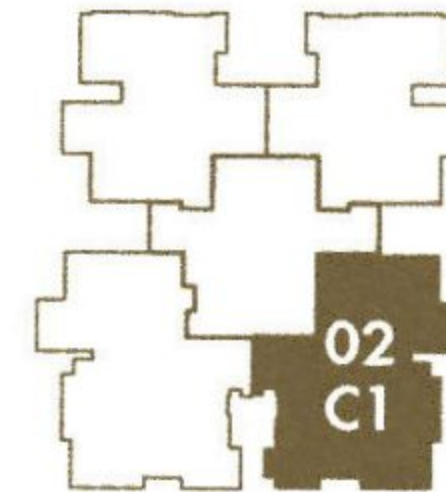

NATHAN ROAD

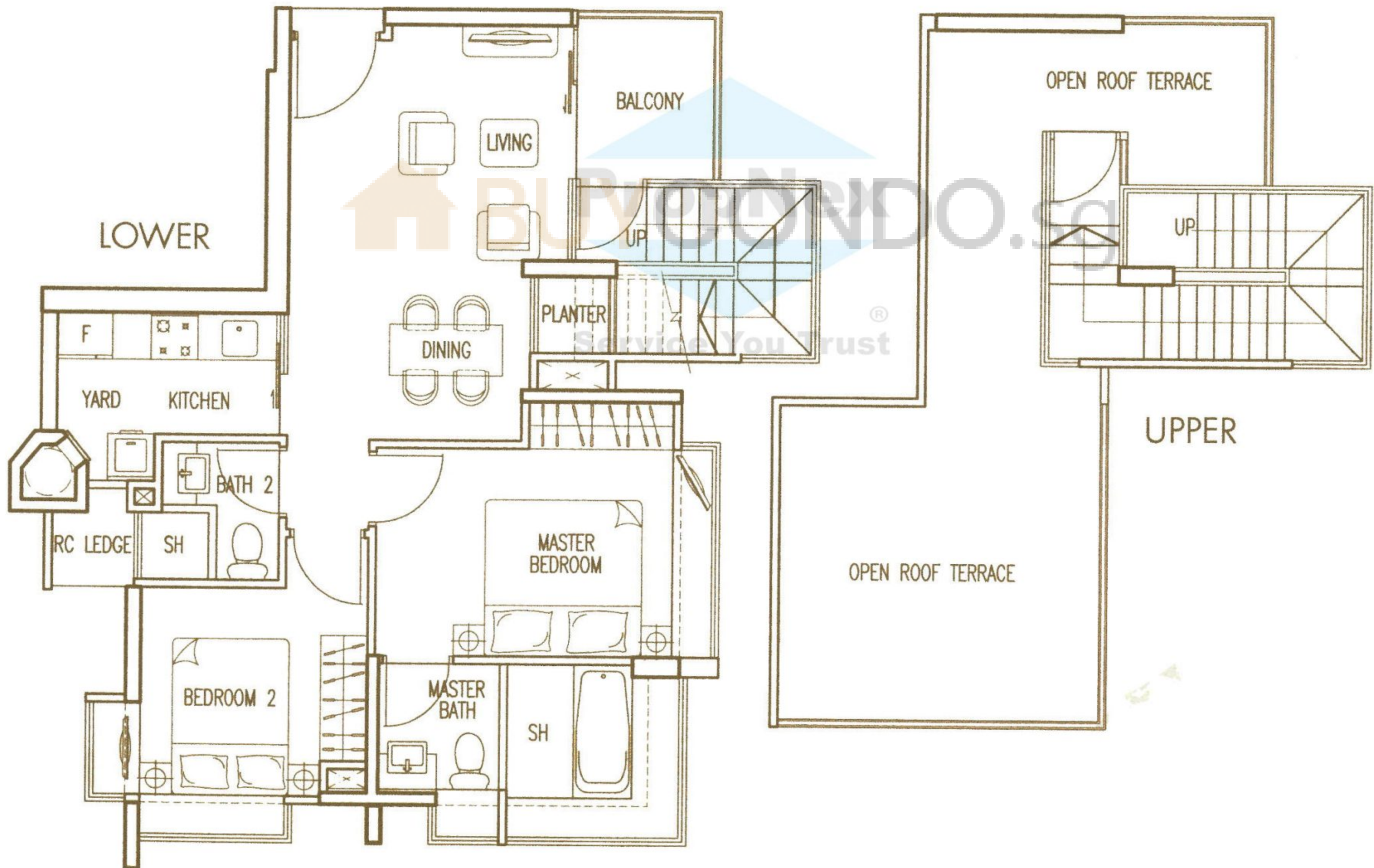

1ST STOREY PLAN
TYPE G — 1 BEDROOM WITH PES
78 sqm / 840 sq ft

Nathan Residences

No.25
#01-05

KEYPLAN
No.23

KEYPLAN
No.25

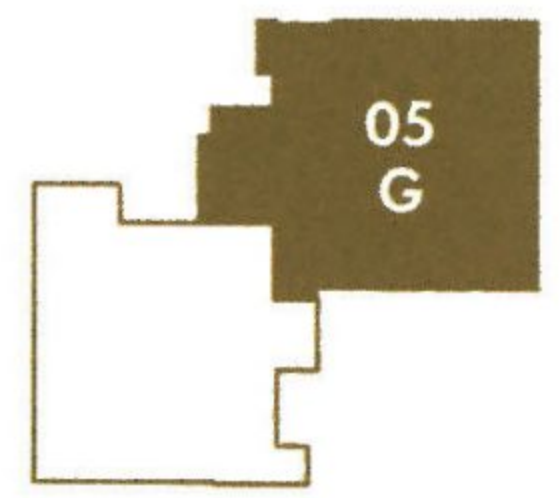
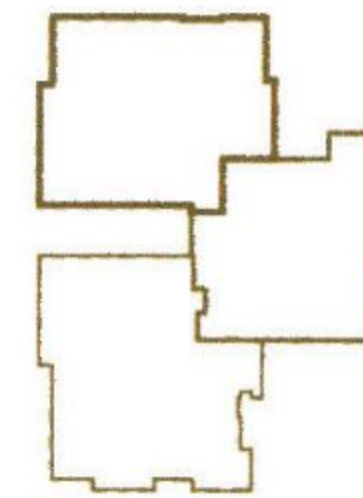

NATHAN ROAD

