

TYPE 1-A3

Unit #01-12

Area 67 sqm / 721 sqft

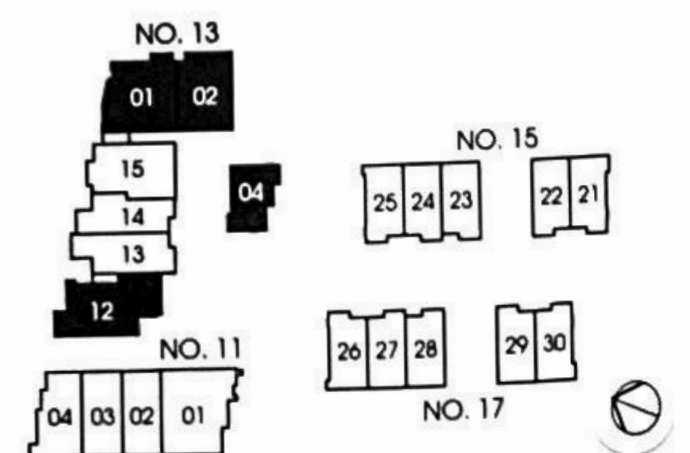
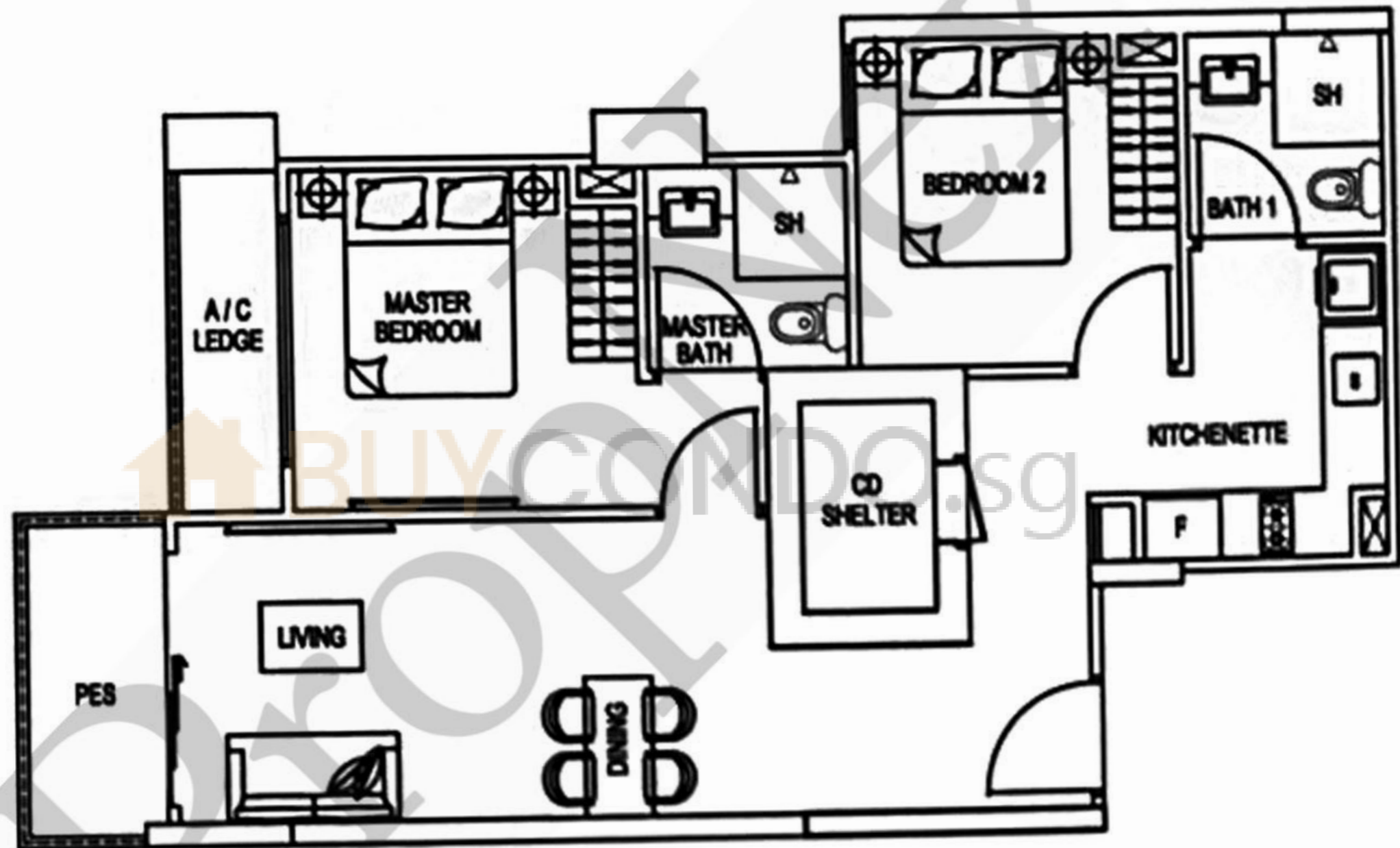

TYPE 1-A4

Unit #01-13

Area 47 sqm / 506 sqft

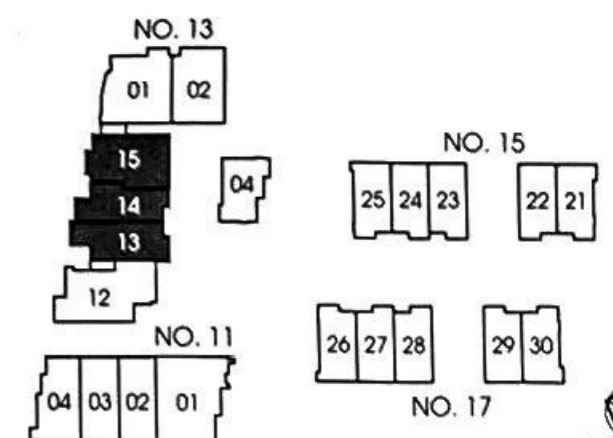
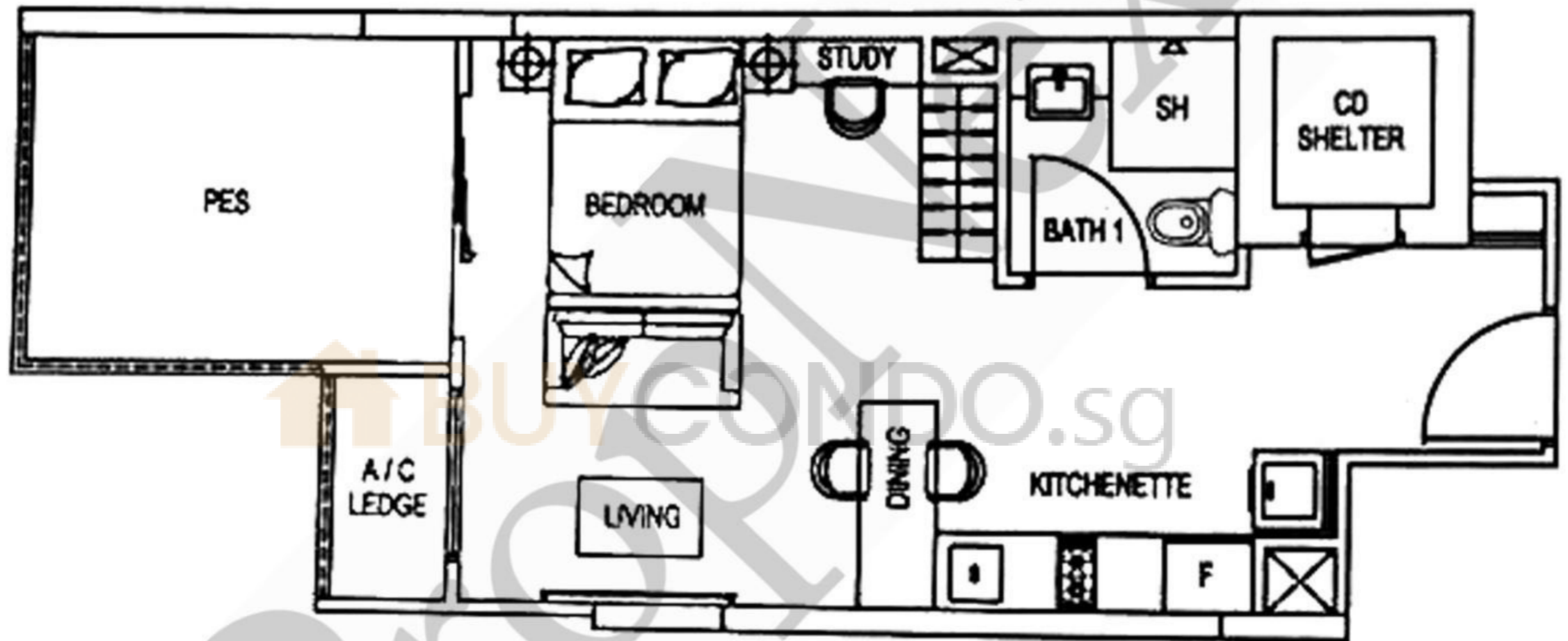

TYPE 1-A5

Unit #01-14

Area 44 sqm / 474 sqft

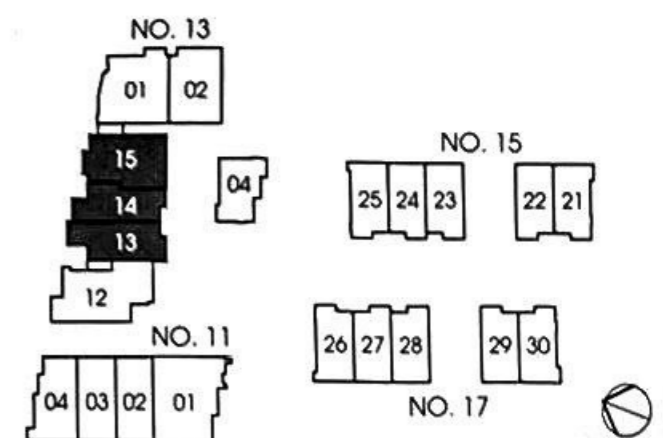
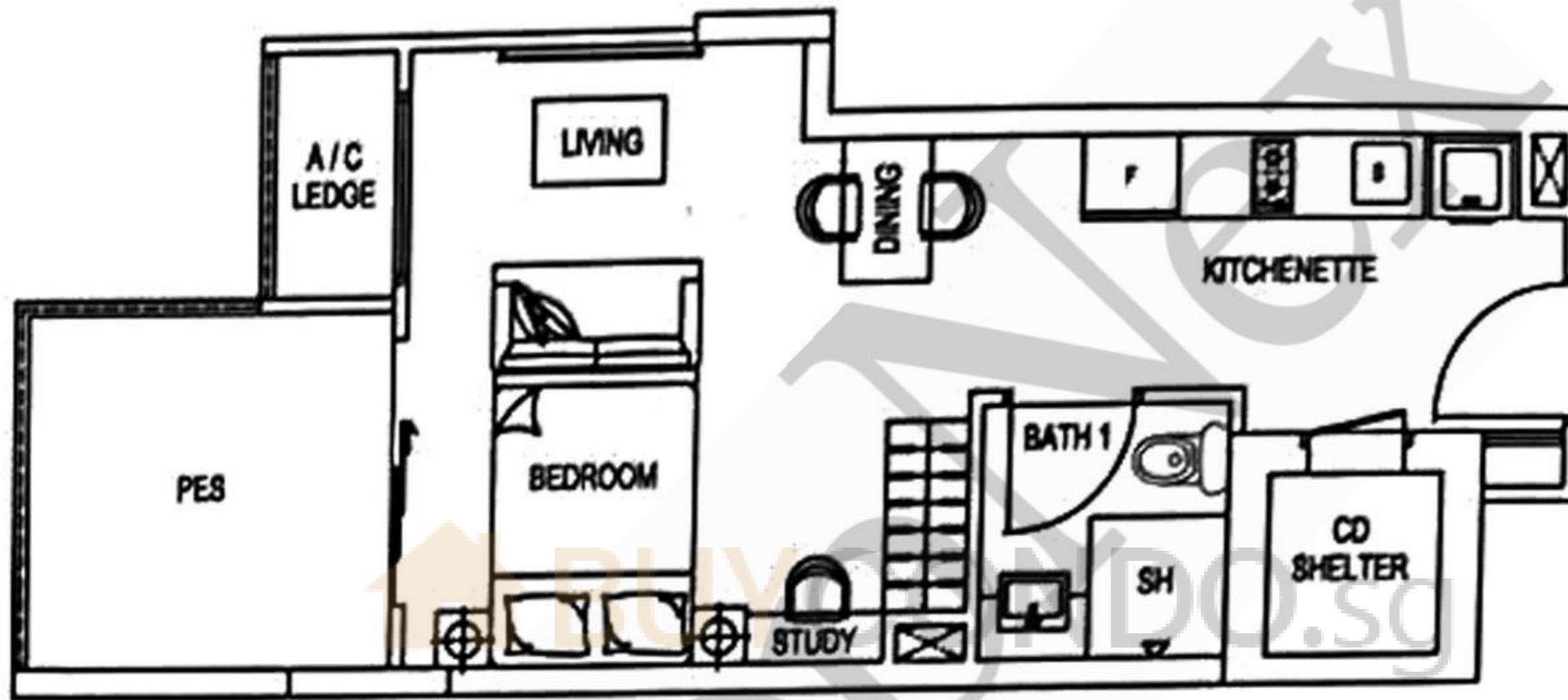

TYPE 1- A6

Unit #01-15

Area 56 sqm / 603 sqft

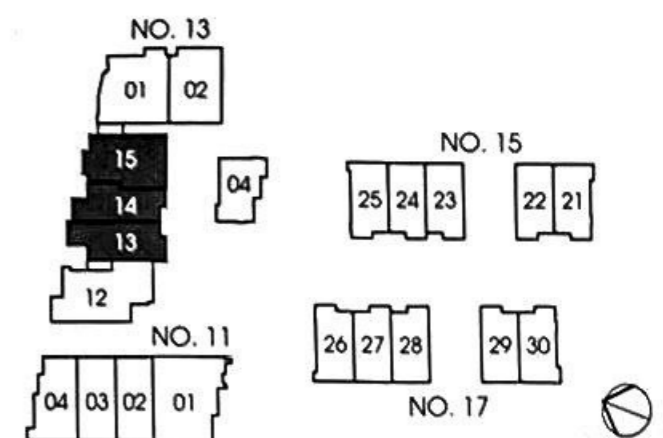
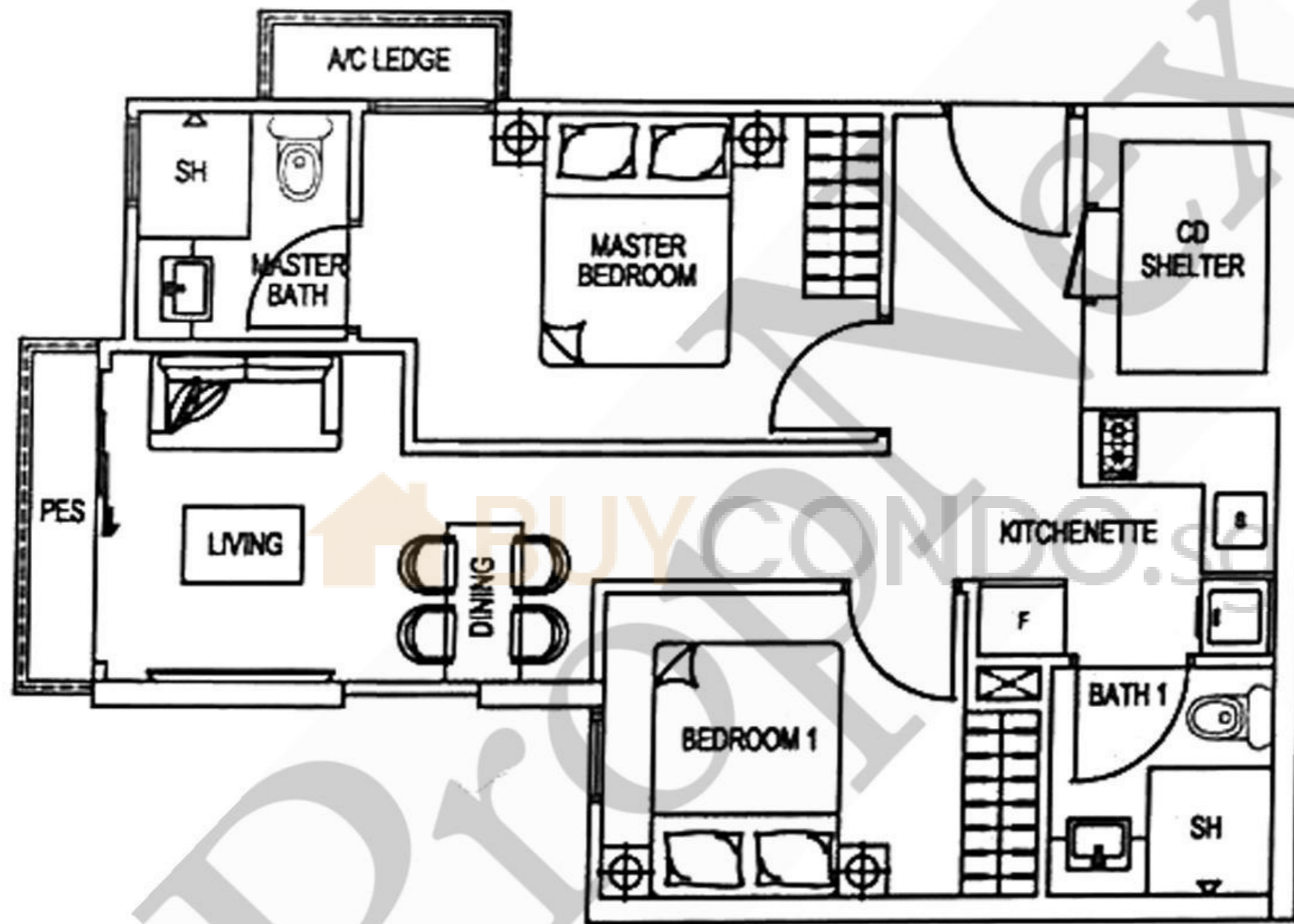

TYPE 1-A7

Unit #01-01

Area 67 sqm / 721 sqft

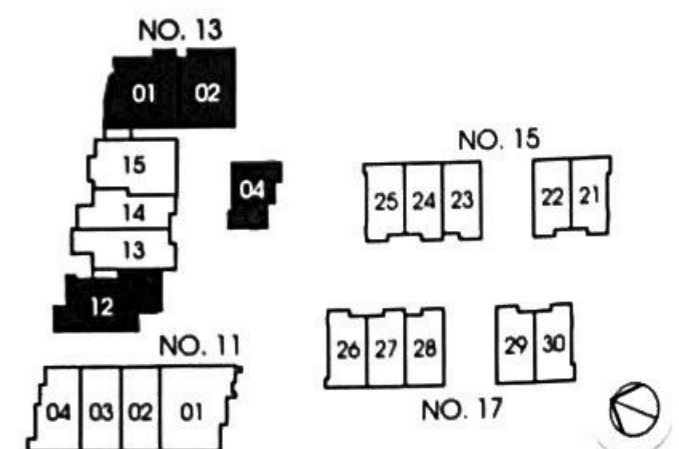

TYPE 1-A8

Unit #01-02

Area 53 sqm / 570 sqft

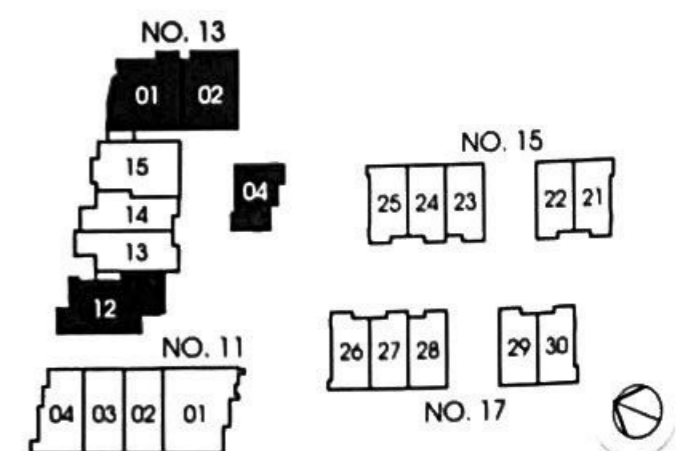
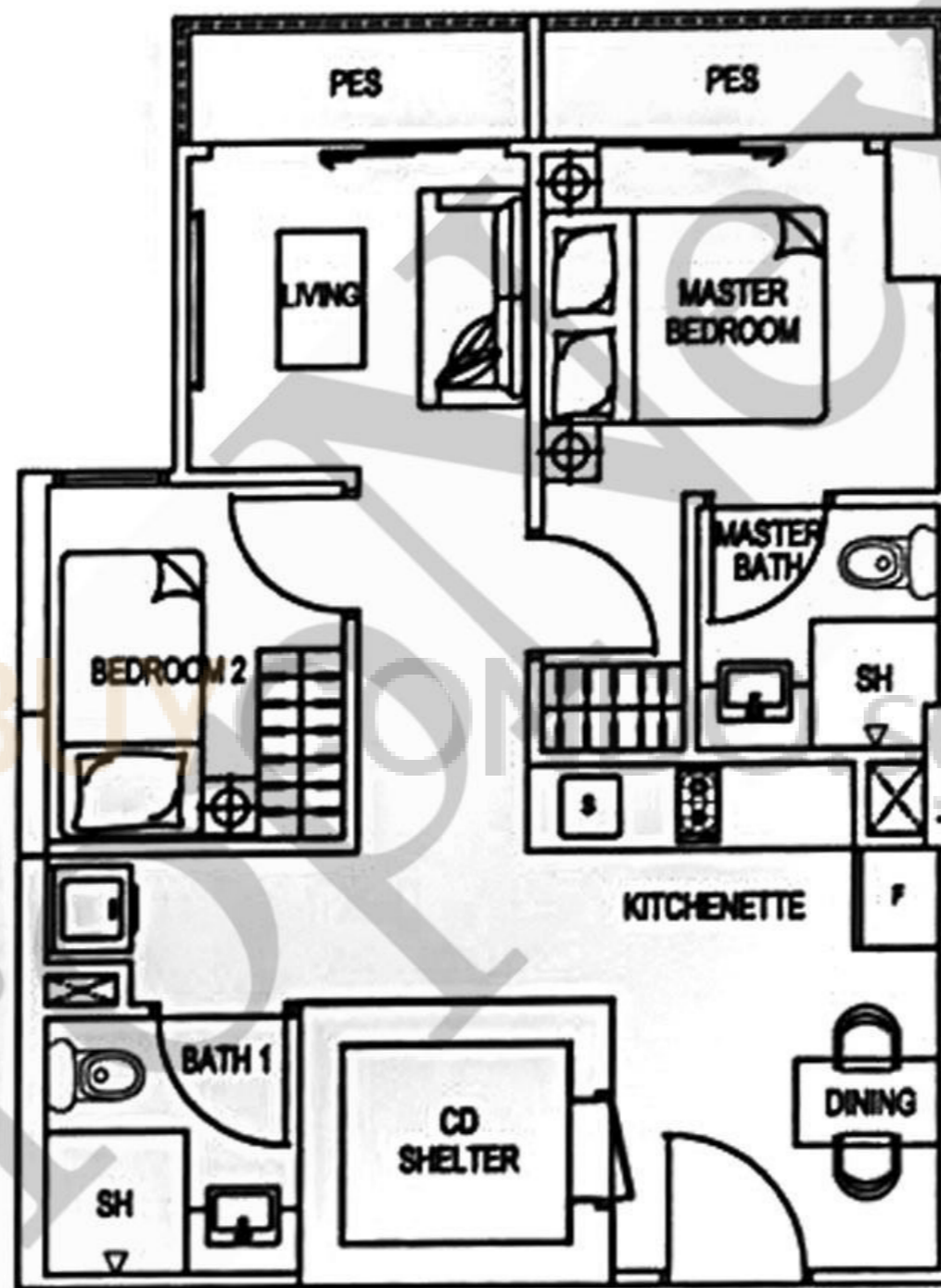

TYPE 1-A10

Unit #01-04

Area 35 sqm / 377 sqft

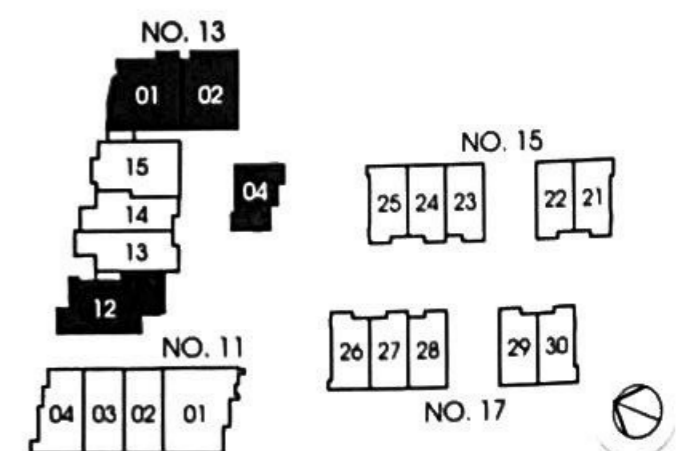
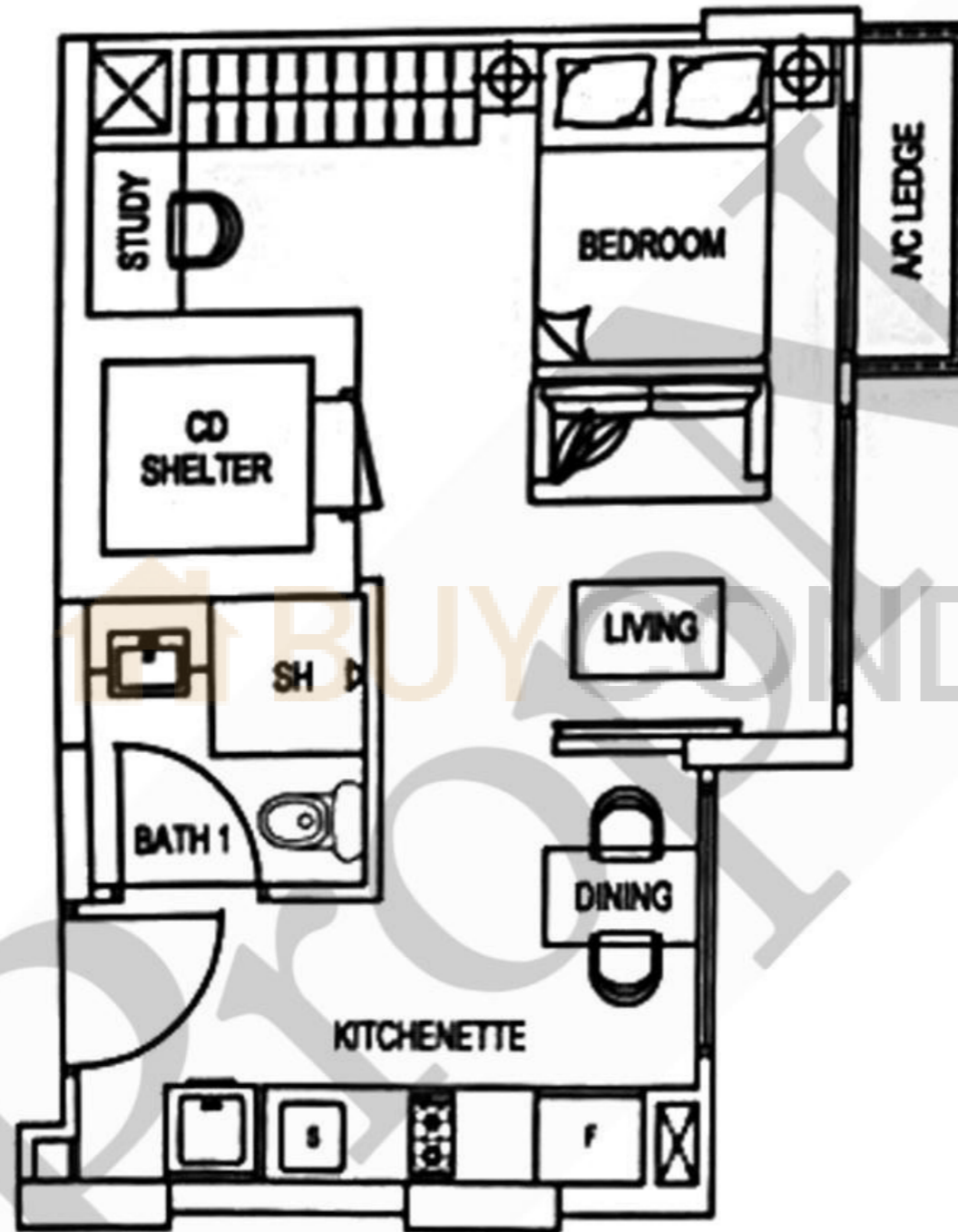

TYPE 1-B5

Unit #01-30

Area 37 sqm / 398 sqft

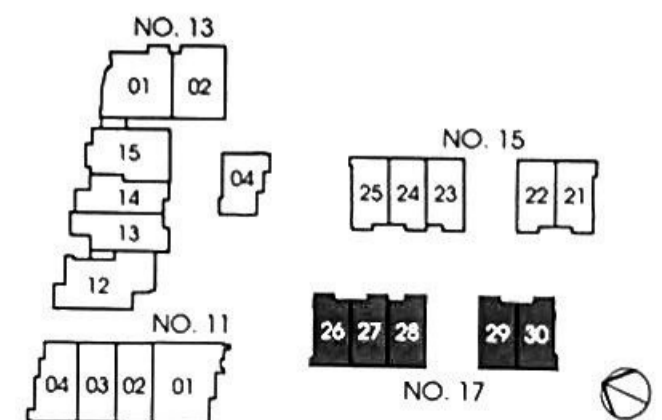
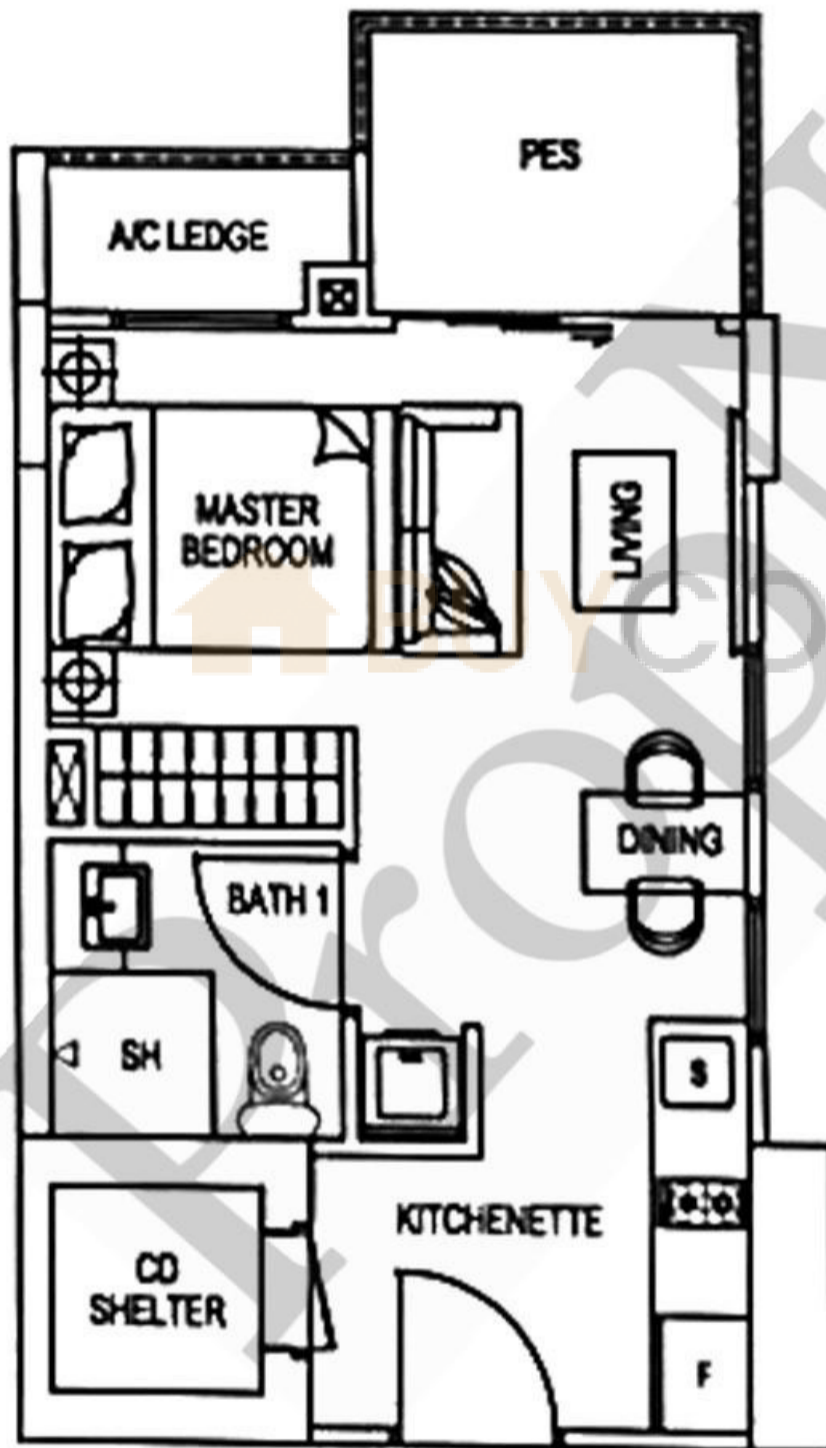

TYPE 1-B6

Unit #01-29

Area 37 sqm / 398 sqft

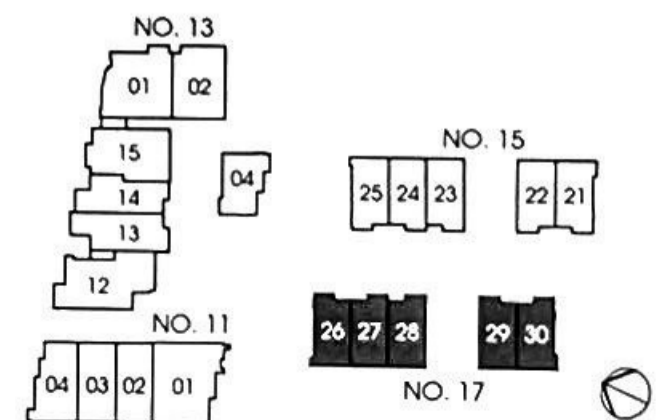

TYPE 1-B7

Unit #01-27, #01-28

Area 37 sqm / 398 sqft

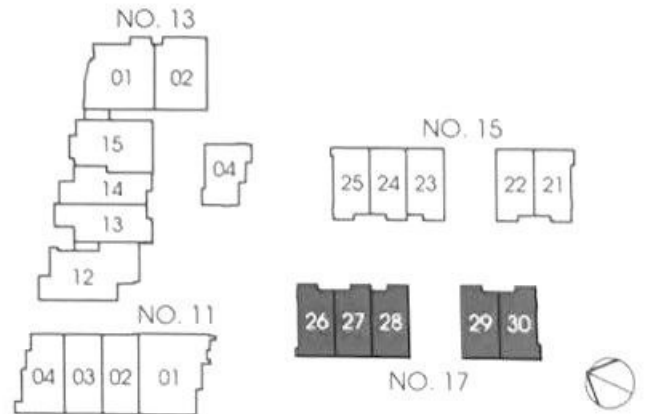

TYPE 1-B8

Unit #01-26

Area 37 sqm / 398 sqft

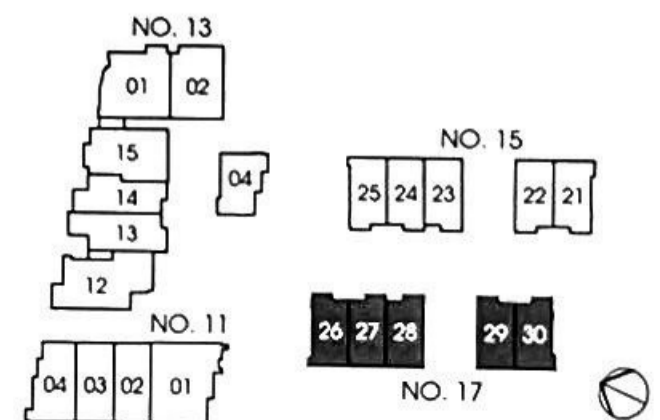

TYPE 1-C5

Unit #01-25

Area 37 sqm / 398 sqft

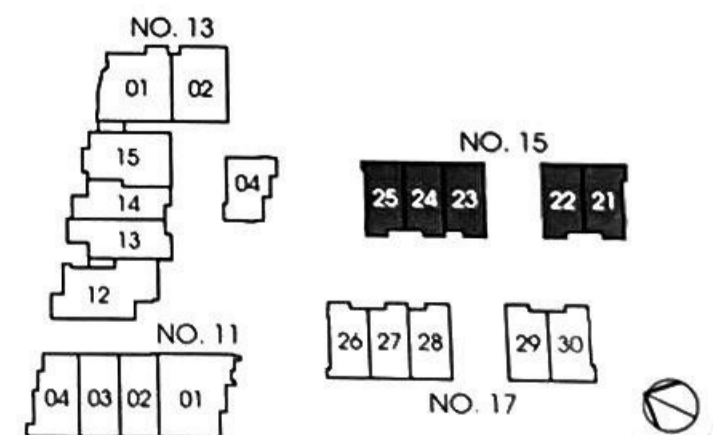
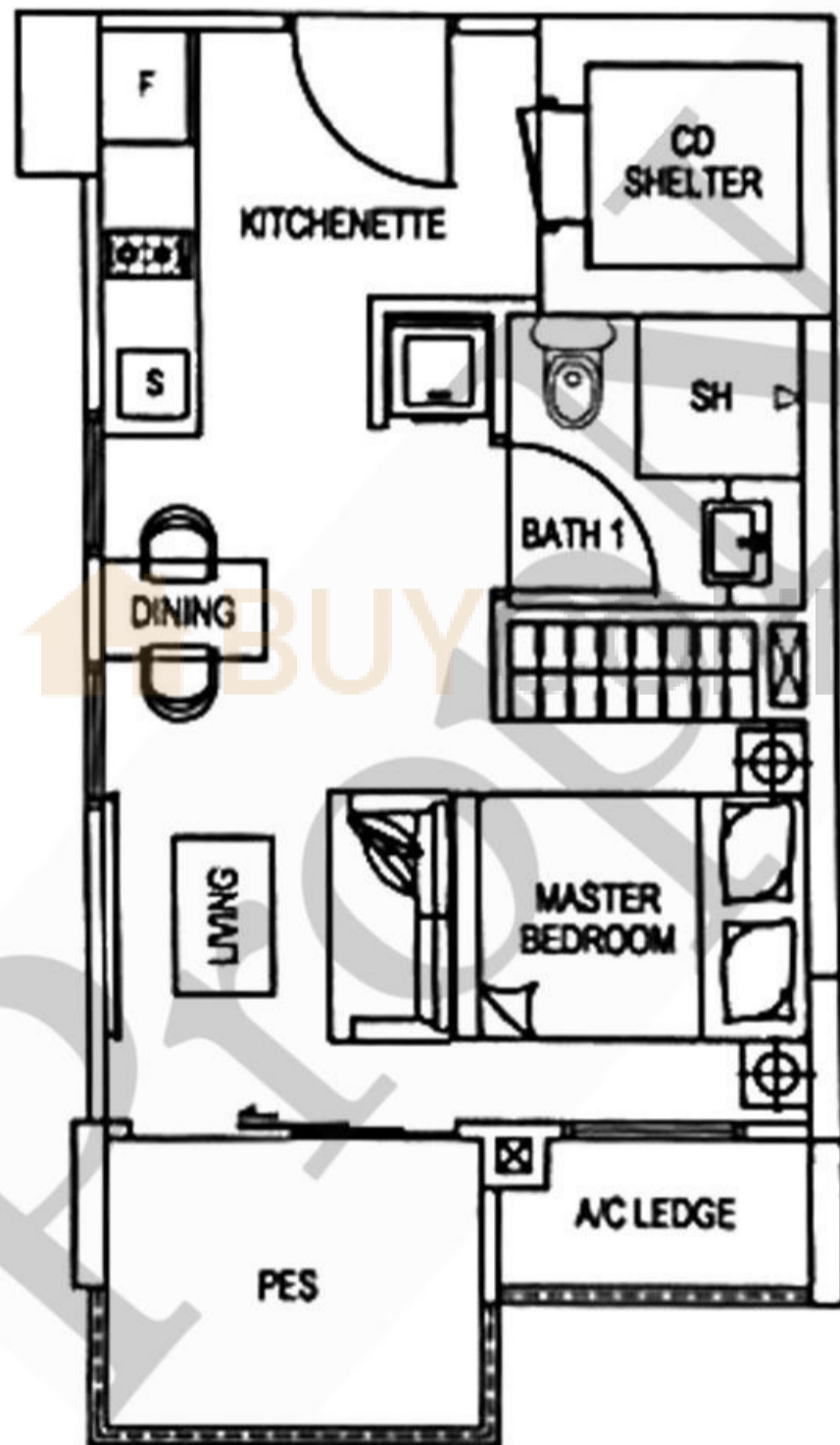

TYPE 1-C6

Unit #01-23, #01-24

Area 37 sqm / 398 sqft

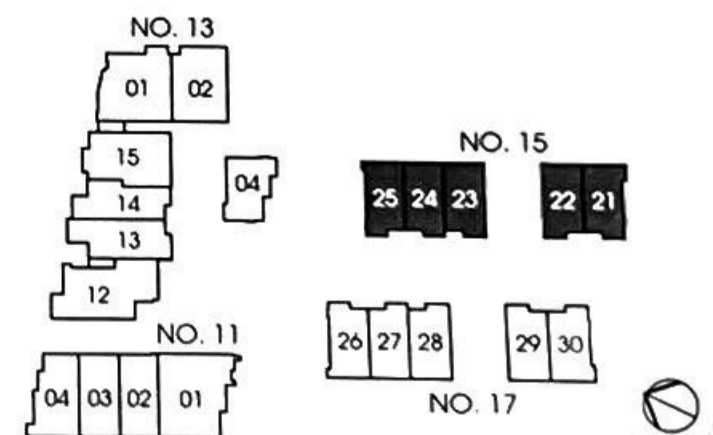

TYPE 1-C7

Unit #01-22

Area 37 sqm / 398 sqft

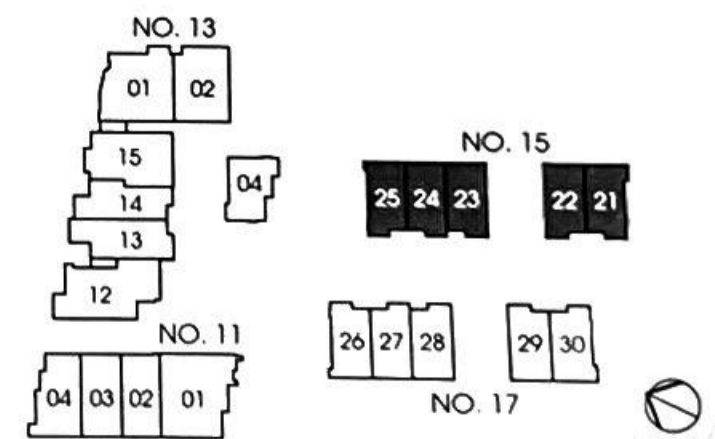
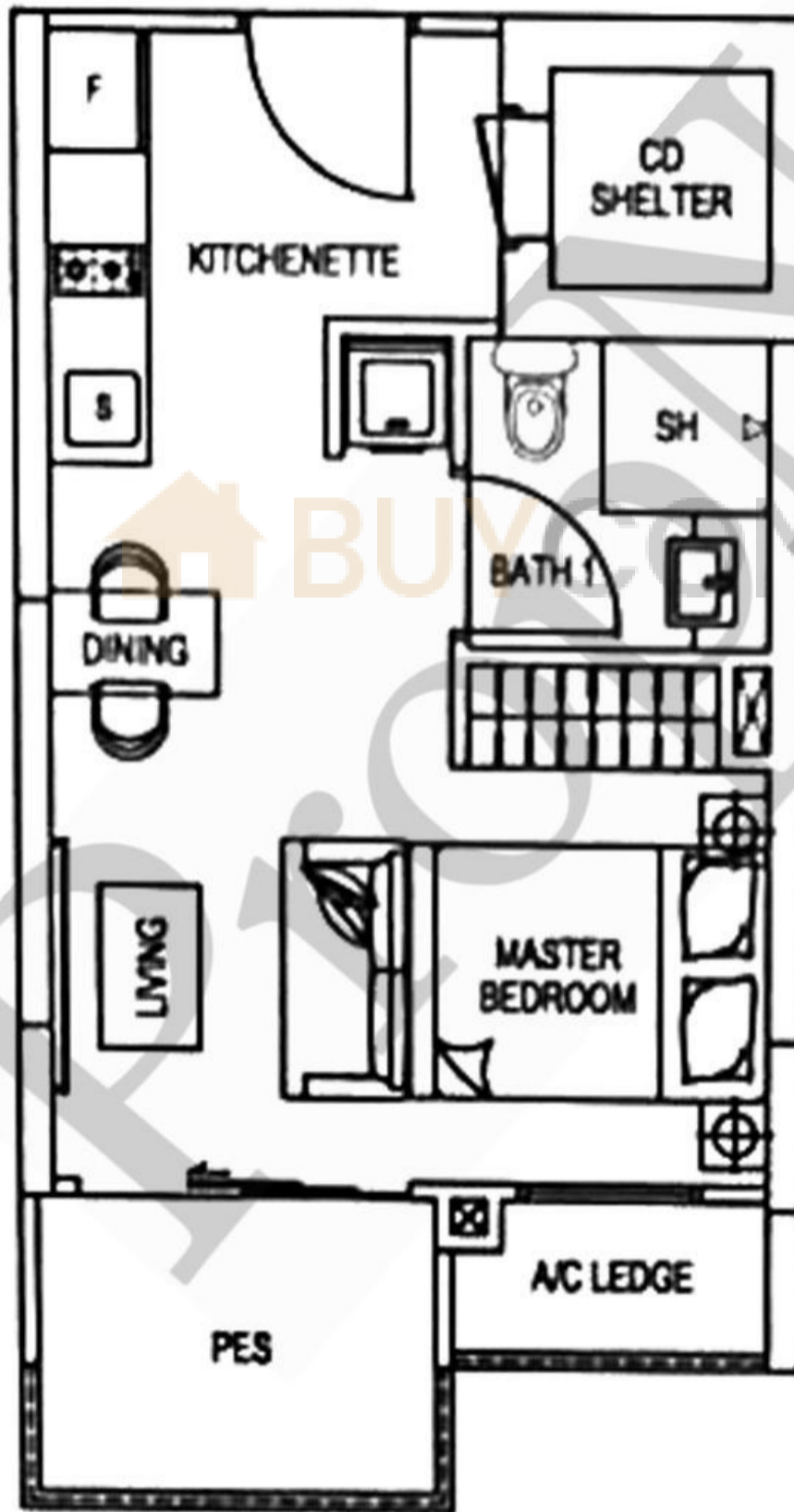

TYPE 1-C8

Unit #01-21

Area 37 sqm / 398 sqft

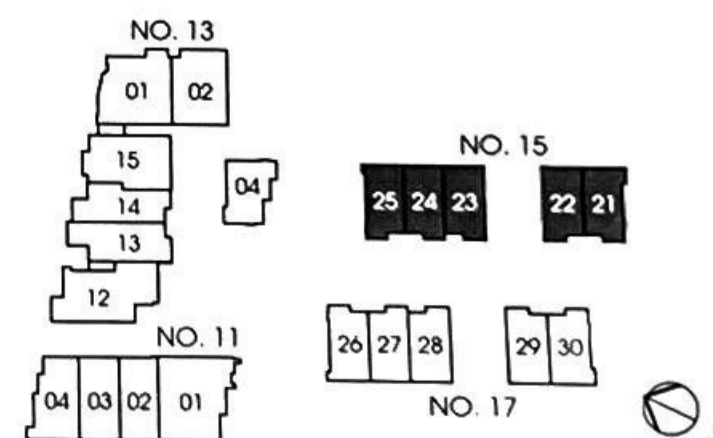
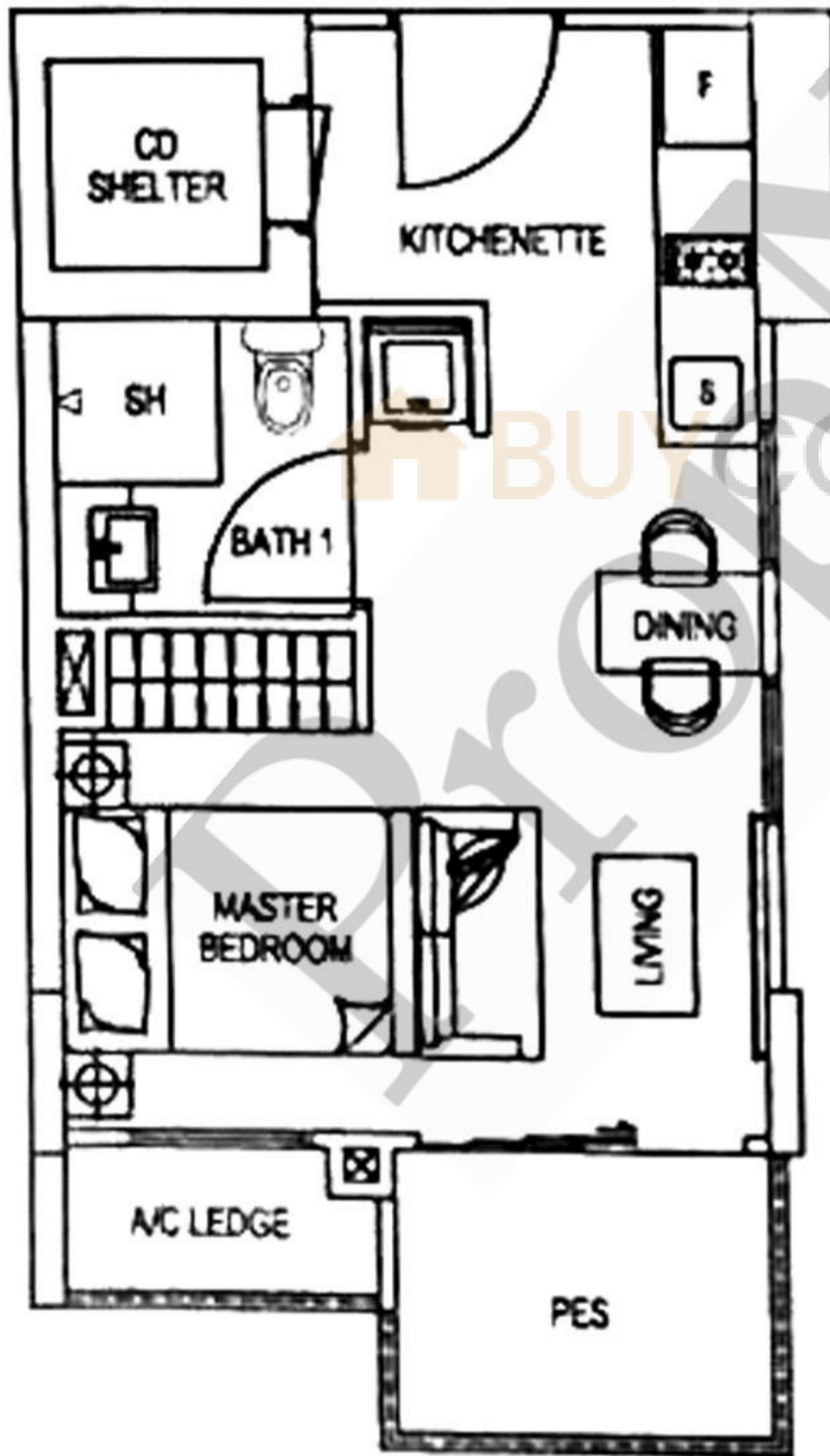

TYPE 2-A1

Unit #05-10
Area 132 sqm / 1421 sqft

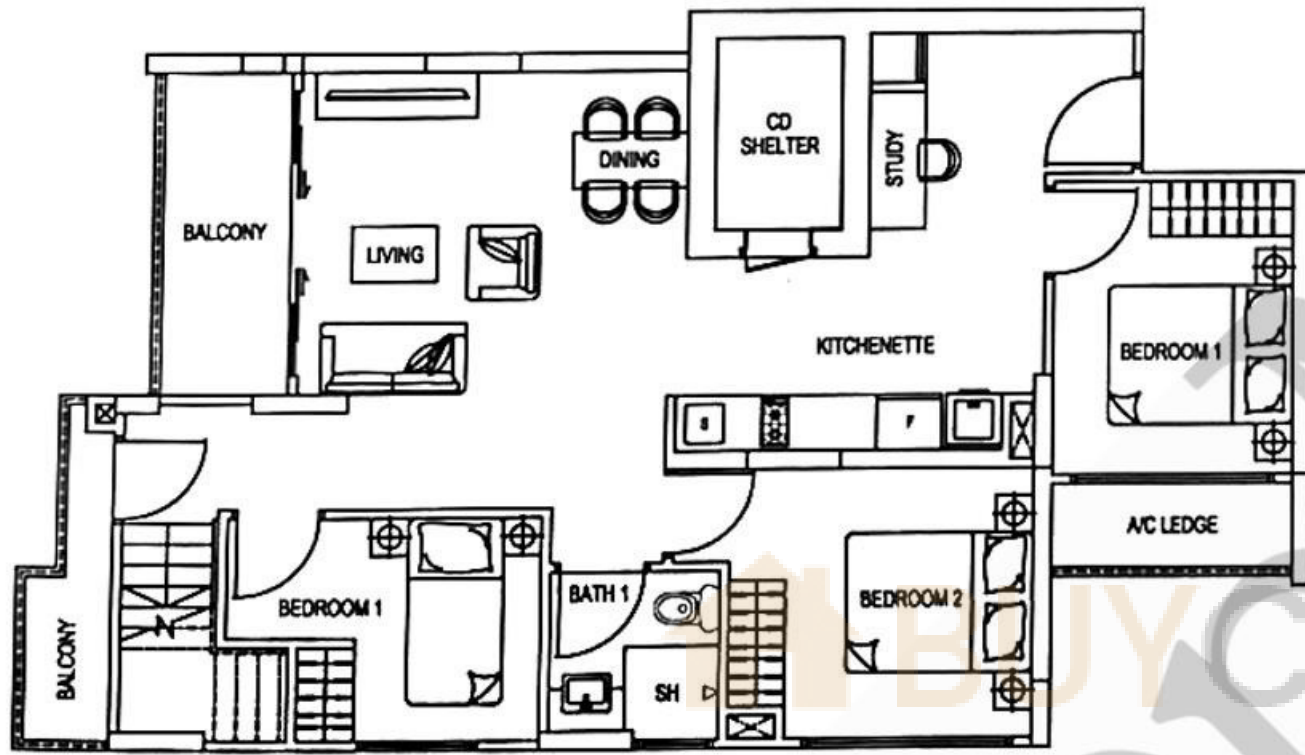

LOWER STOREY

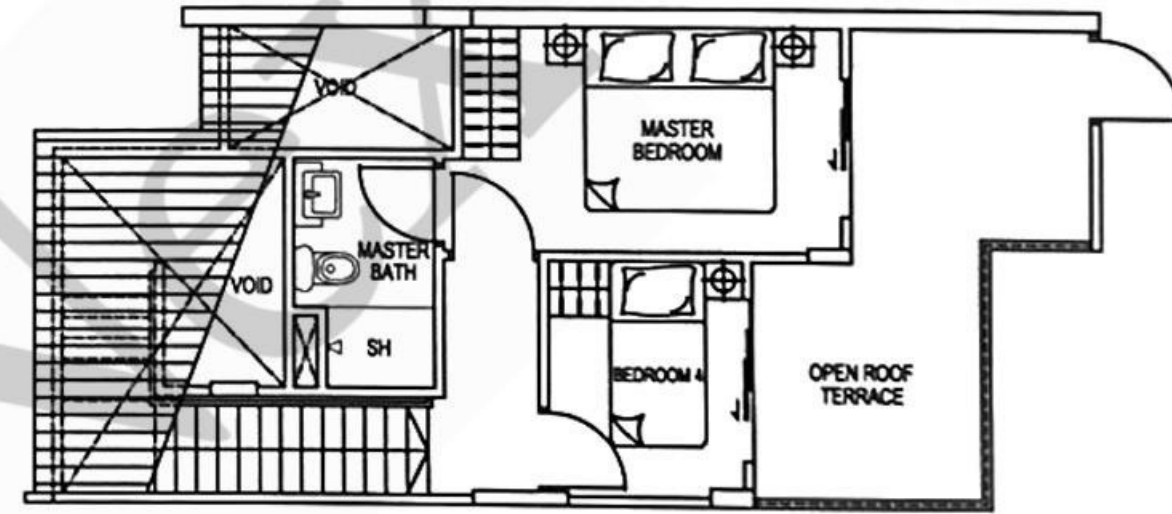

UPPER STOREY

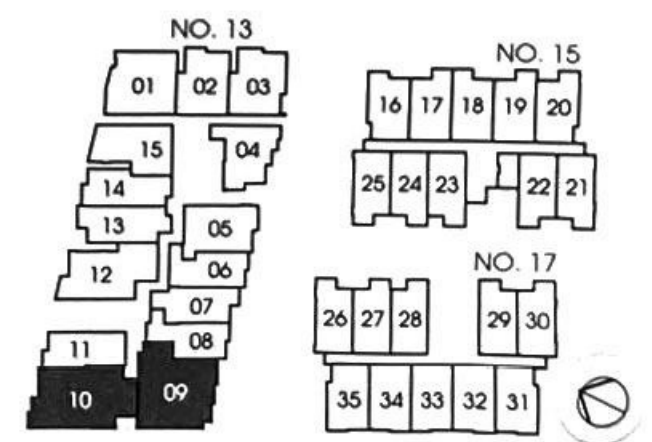

TYPE 2-A2

Unit #05-11
Area 88 sqm / 947 sqft

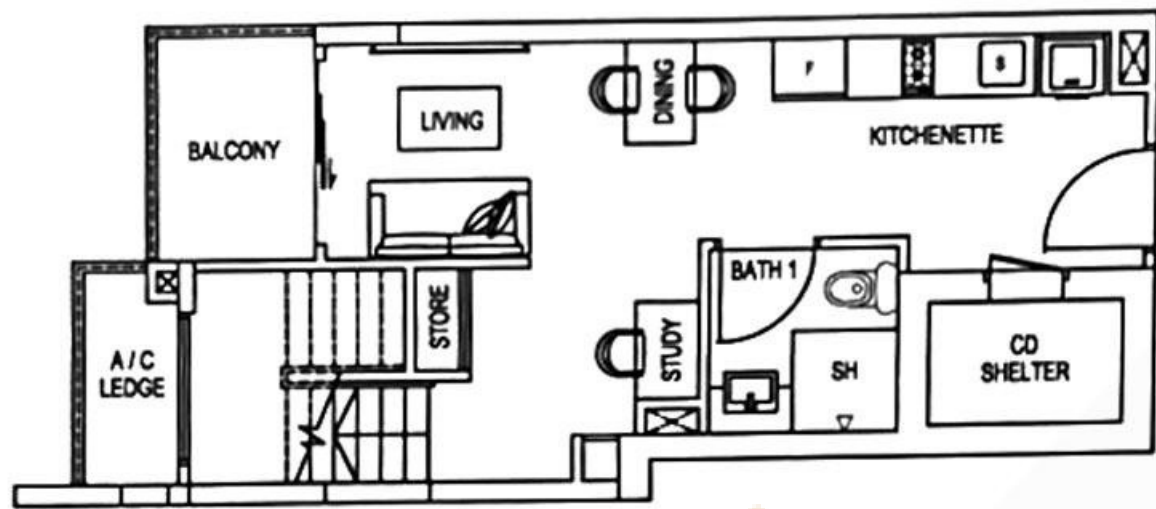

LOWER STOREY

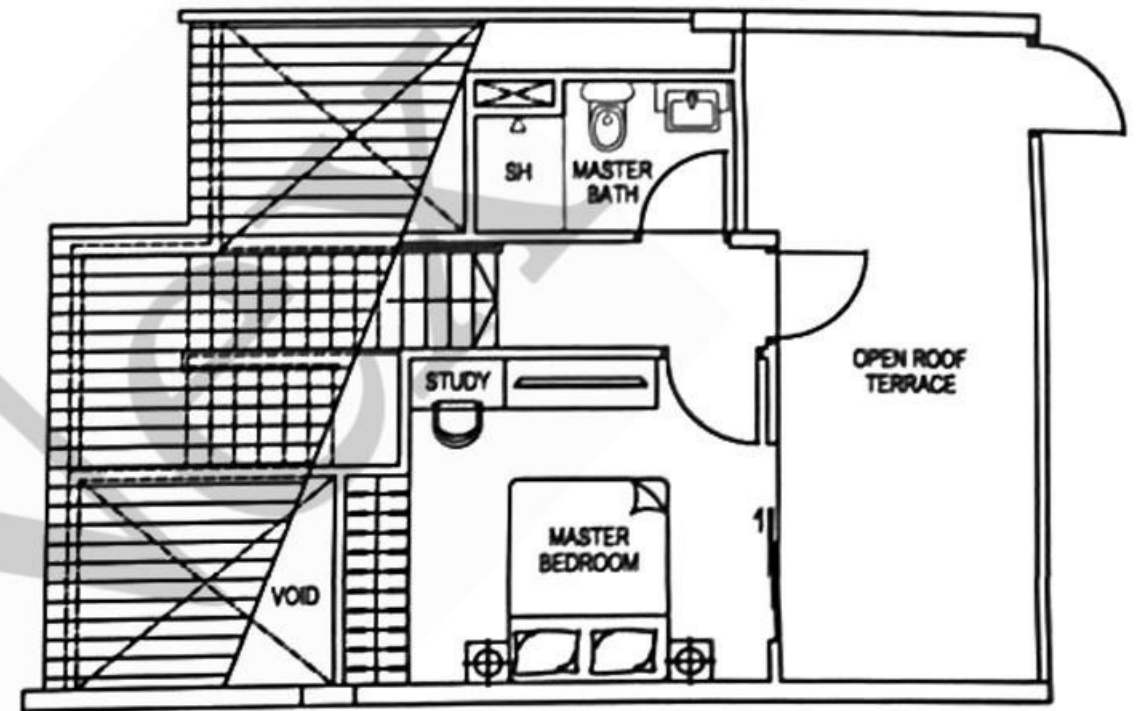

UPPER STOREY

 BUYCONDO.sg

PROPT

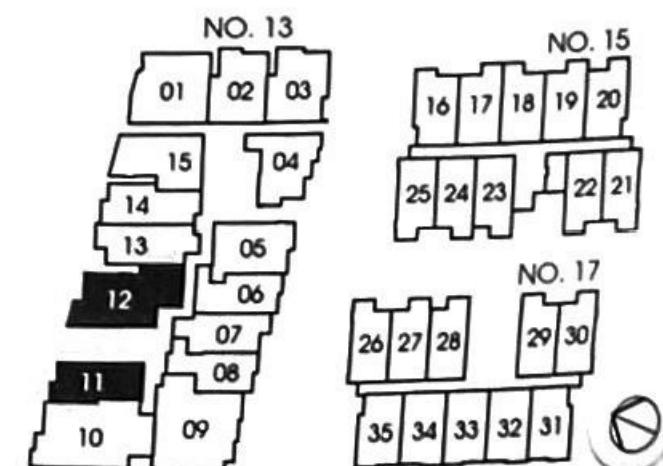

TYPE 2-A3

Unit #05-12
Area 117 sqm / 1259 sqft

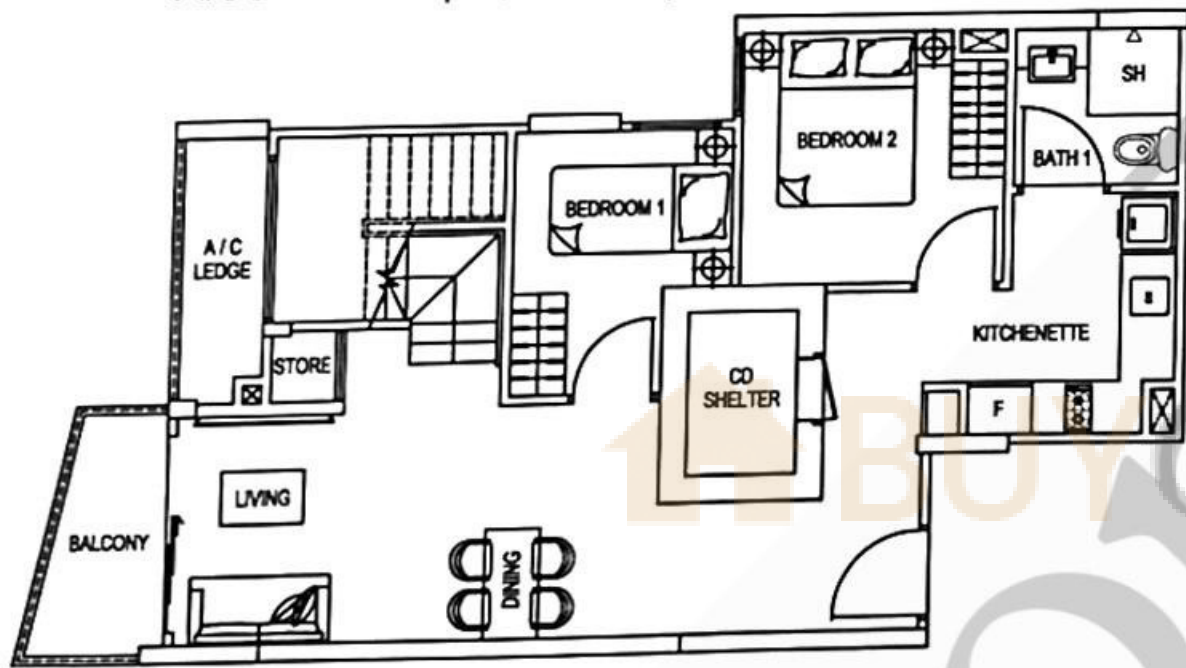

LOWER STOREY

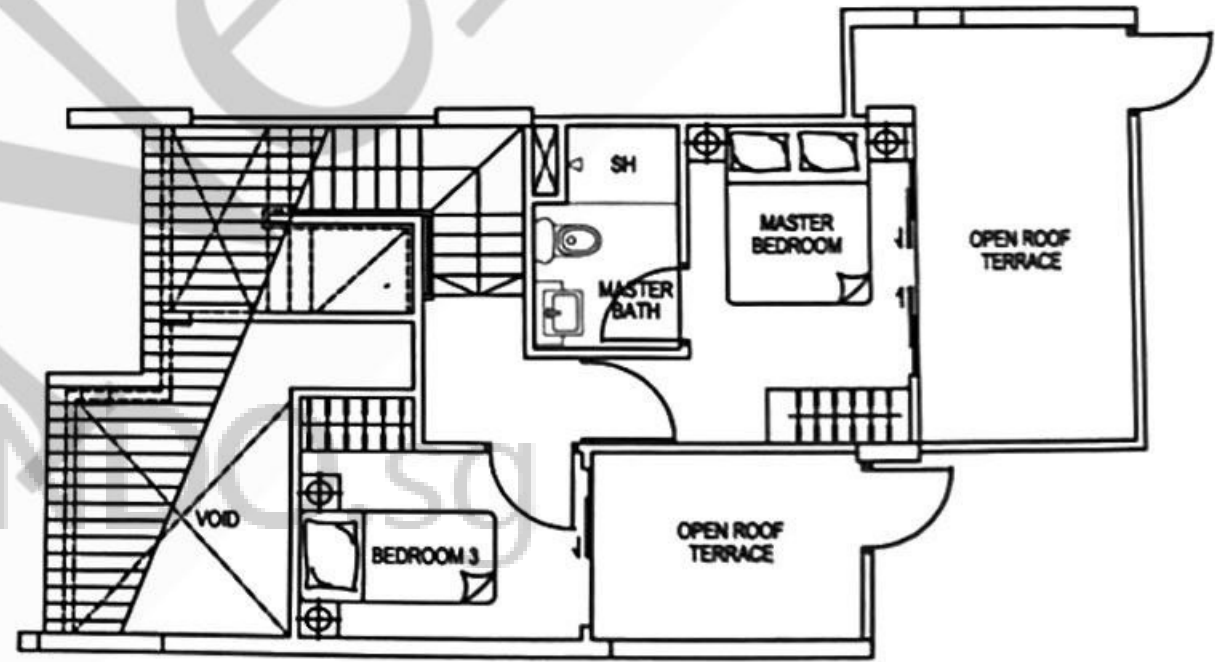

UPPER STOREY

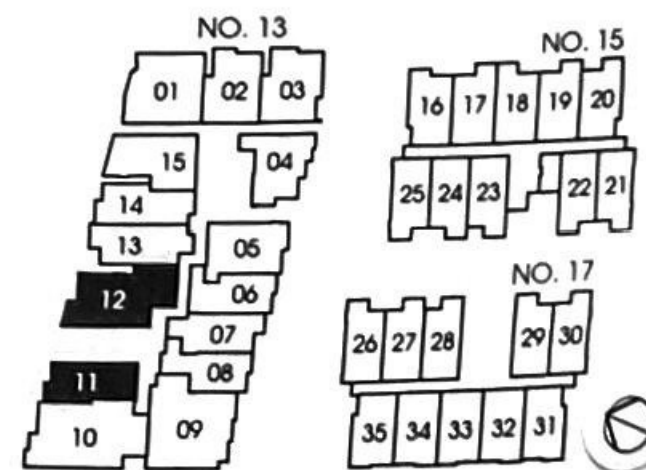

TYPE 2-A4

Unit #05-13
Area 77 sqm / 829 sqft

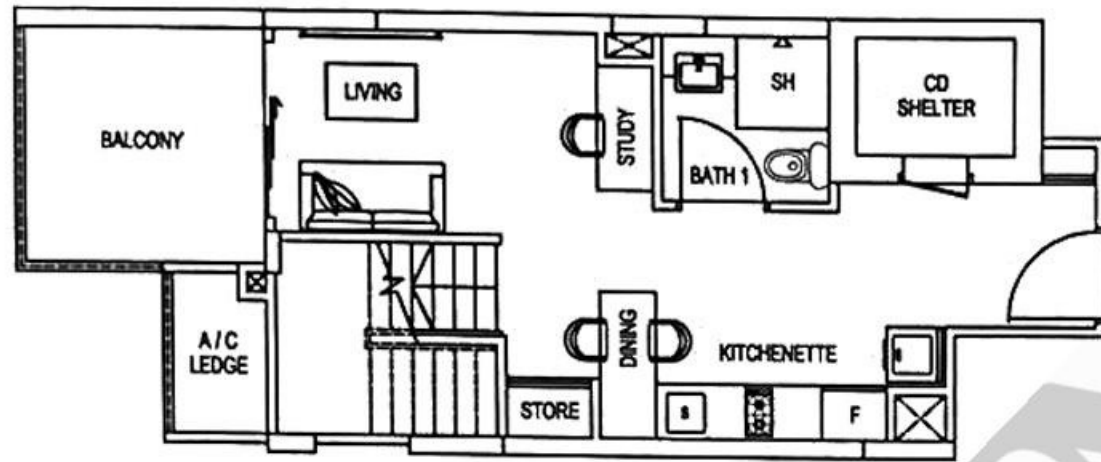

LOWER STOREY

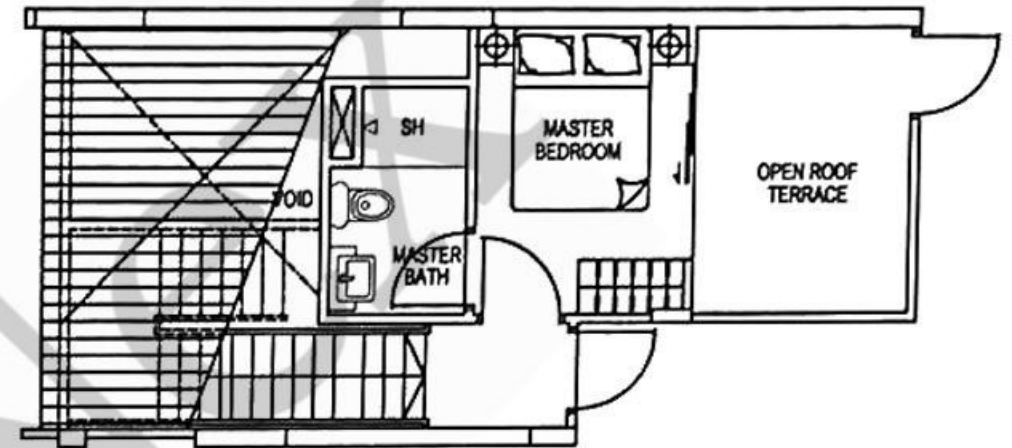

UPPER STOREY

 BUY CONDO.sg

PROPT

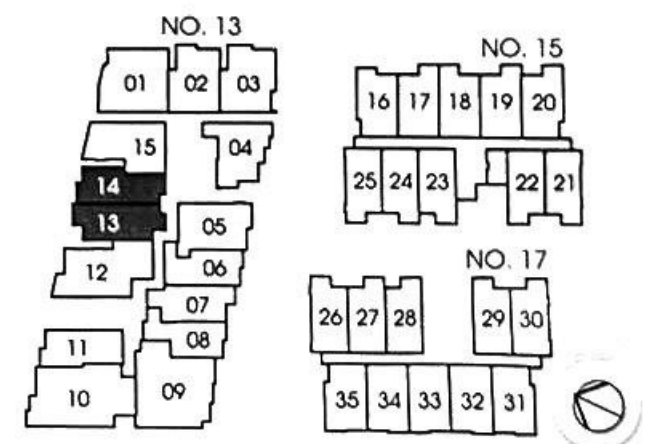

TYPE 2-A6

Unit #05-15
Area 91 sqm / 980 sqft

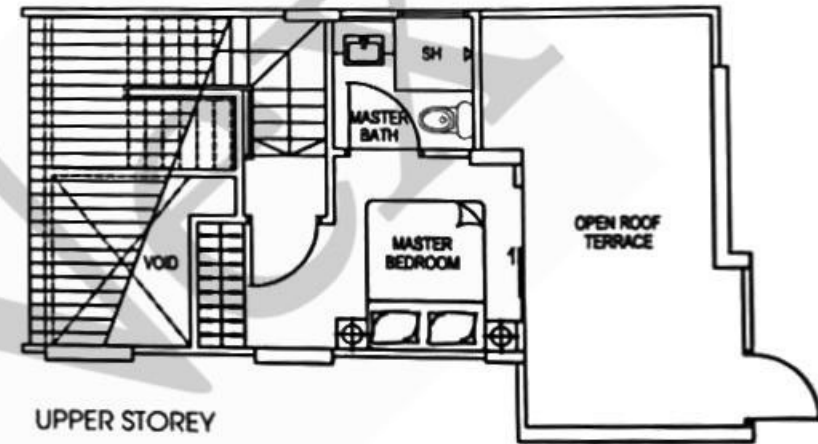
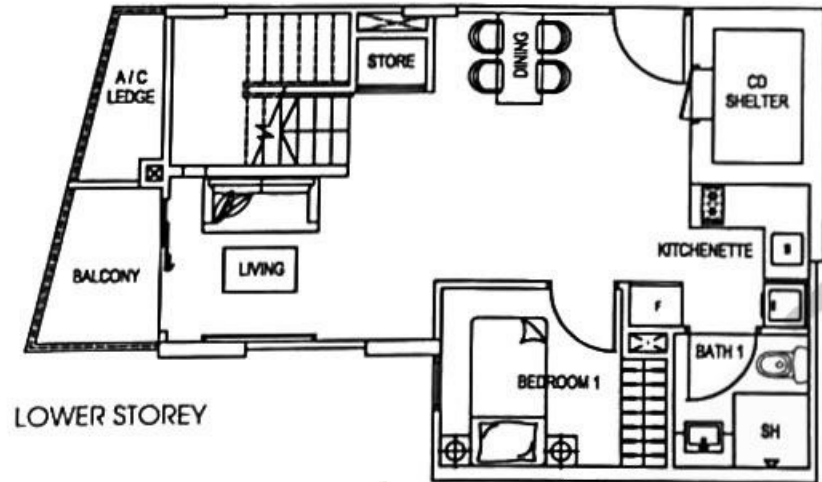

BUYCONDO.sg

PROPT

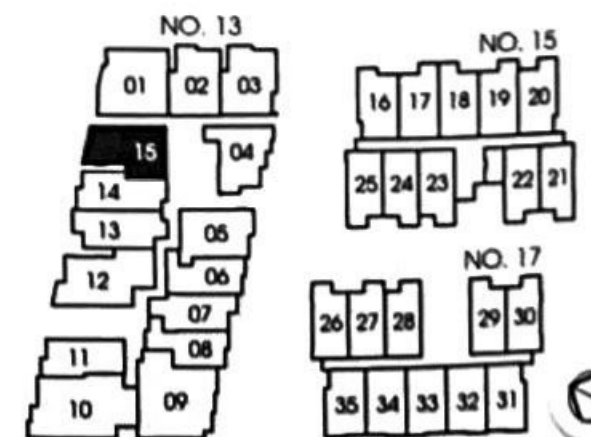

TYPE 2-A7

Unit #05-01
Area 126 sqm / 1356 sqft

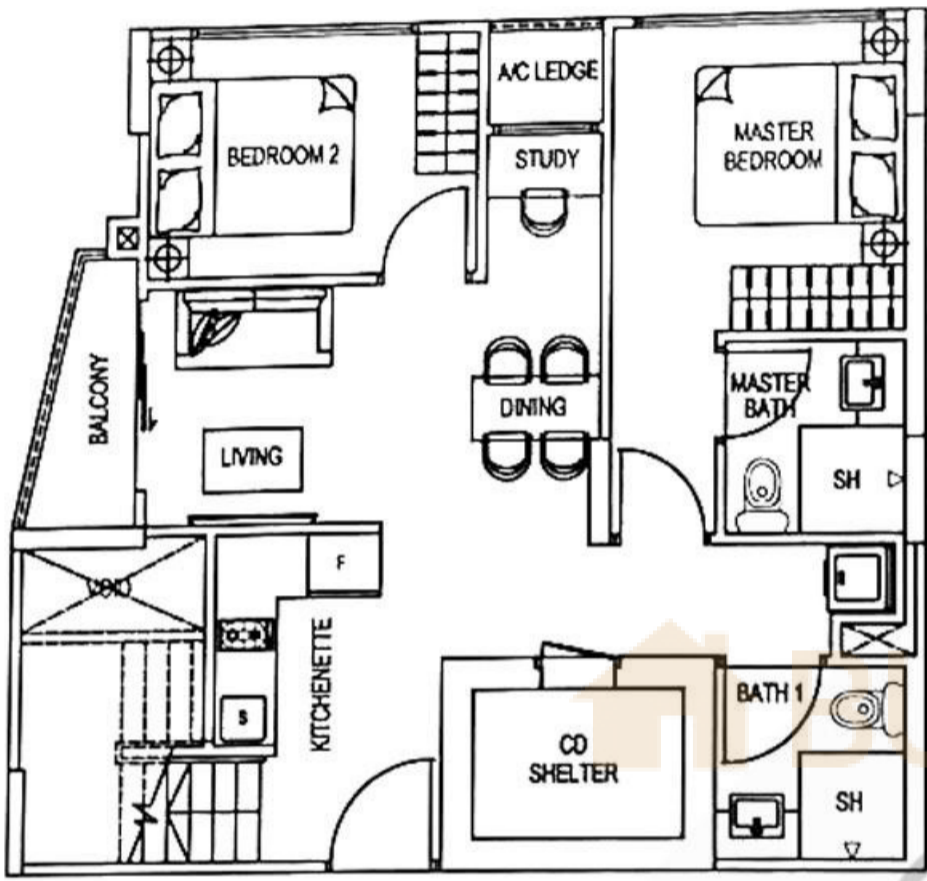

LOWER STOREY

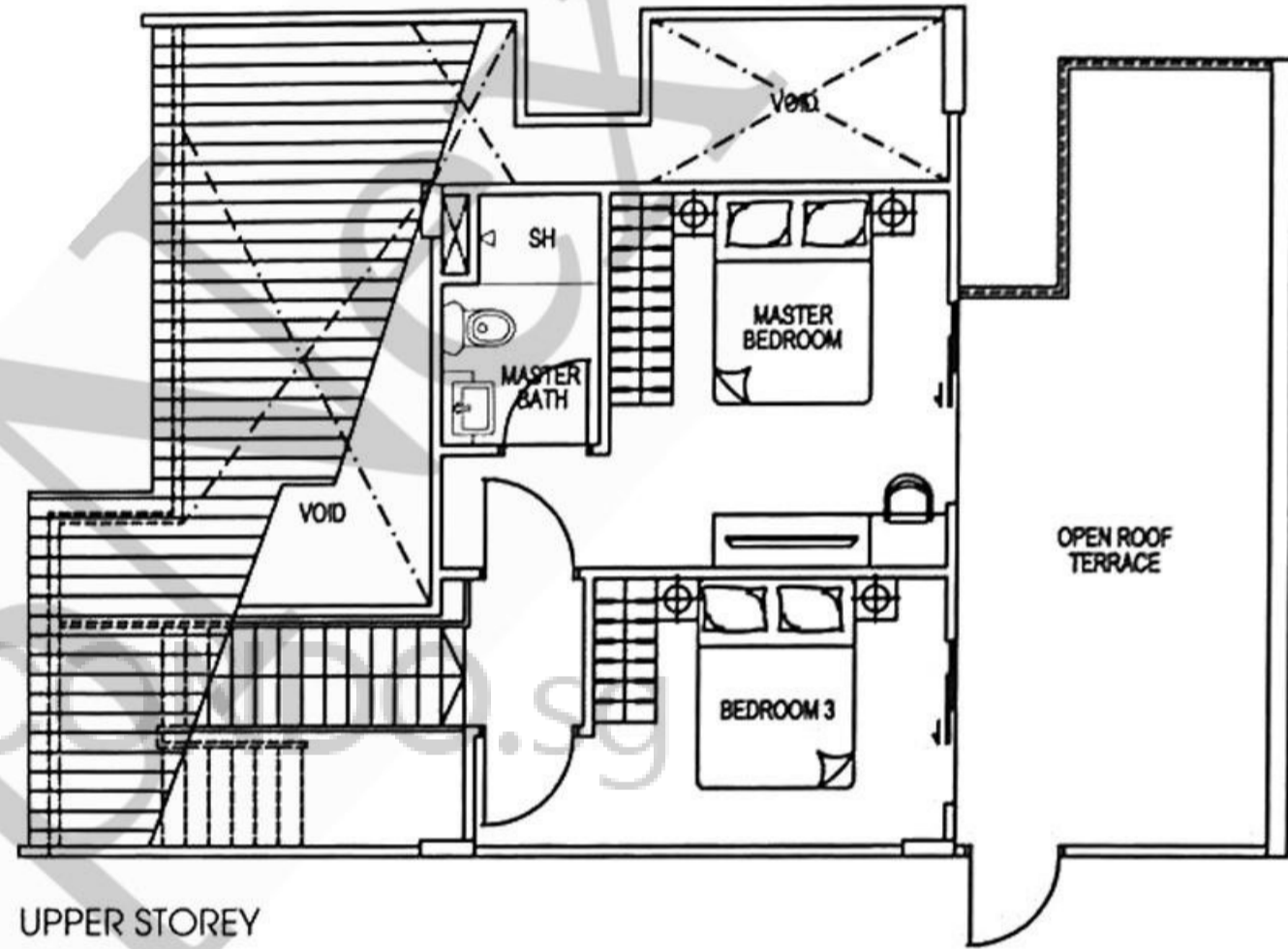

UPPER STOREY

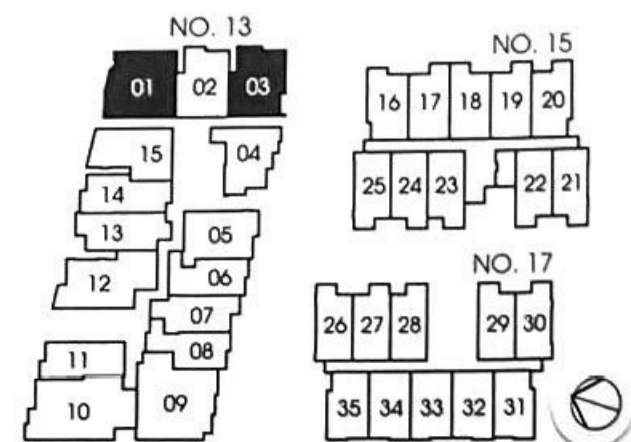

TYPE 2-A9

Unit #05-03

Area 134 sqm / 1442 sqft

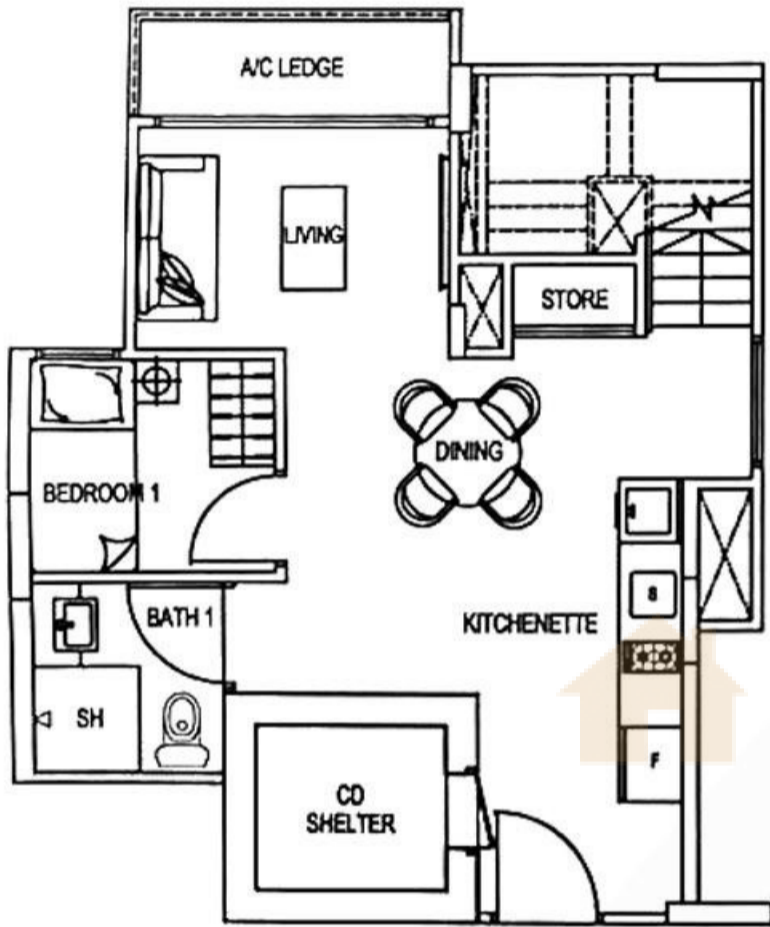

LOWER STOREY

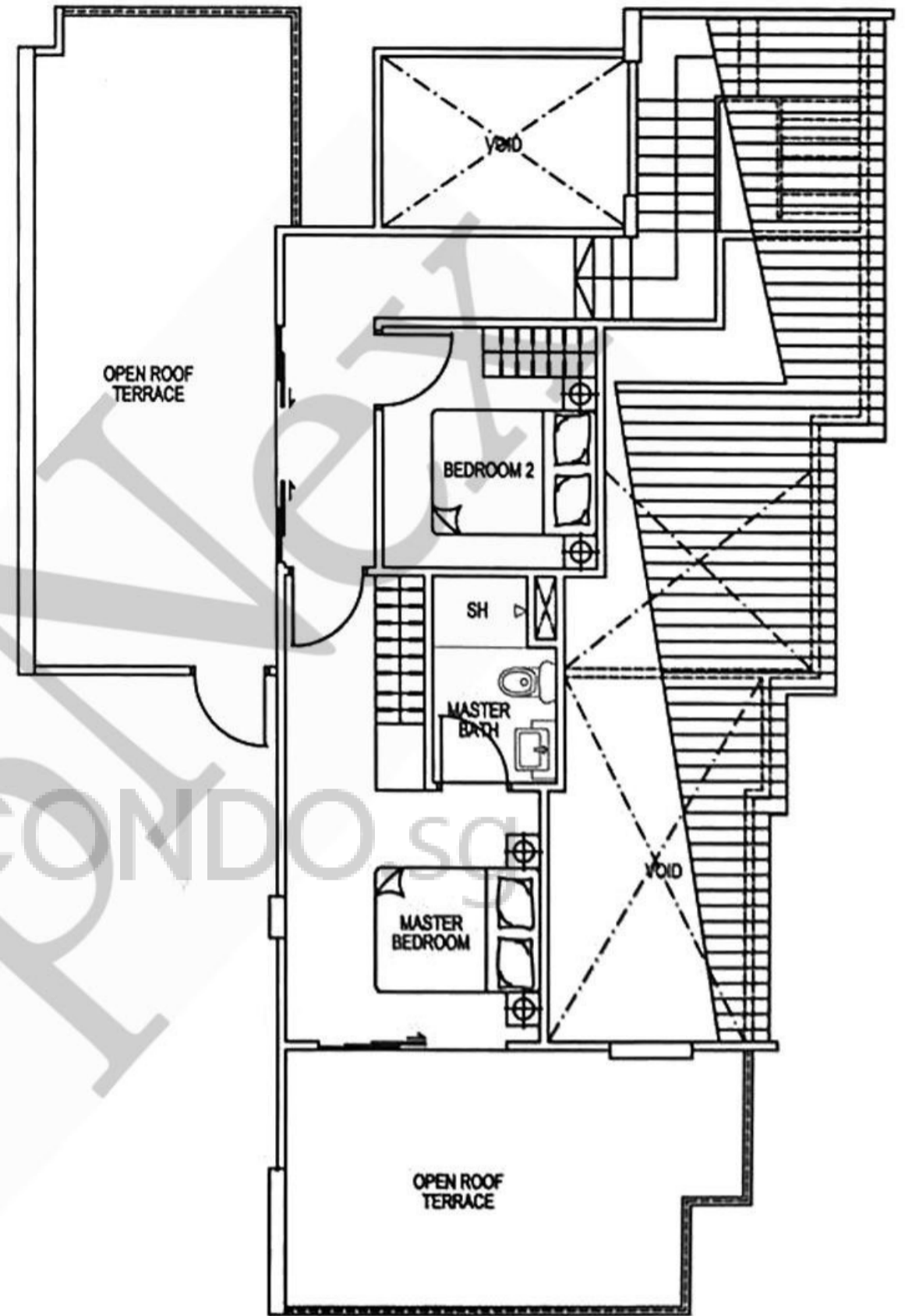

UPPER STOREY

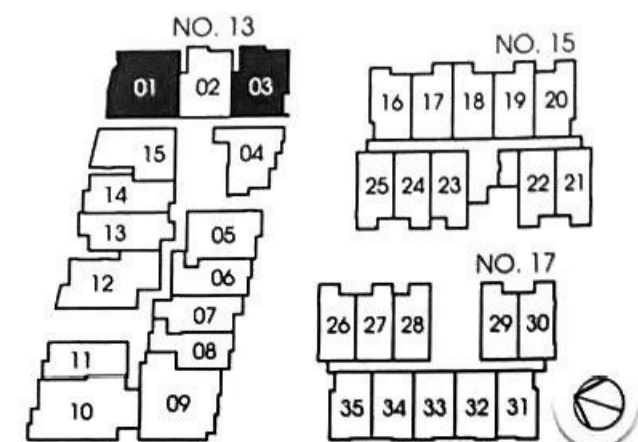

TYPE 2-A11

Unit #05-05

Area 89 sqm / 958 sqft

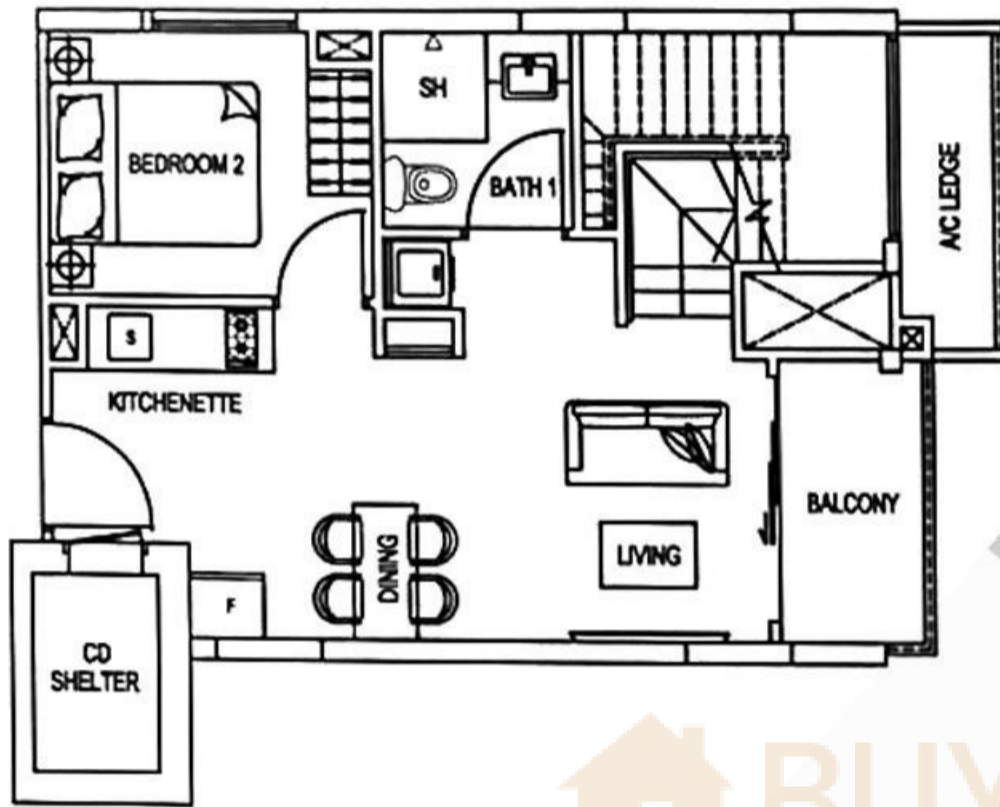

LOWER STOREY

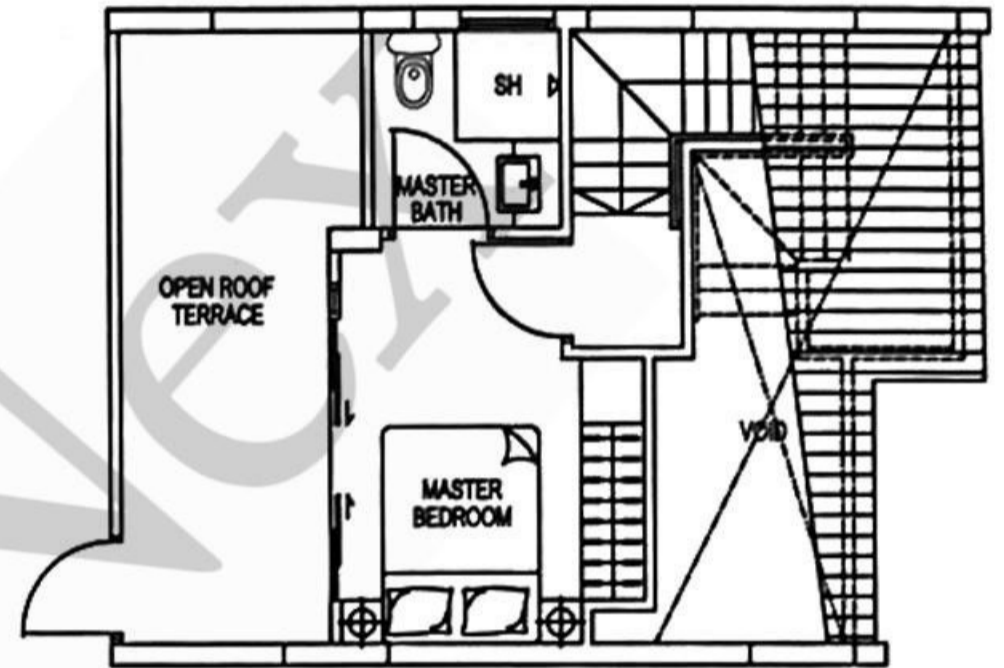

UPPER STOREY

BUYCONDO.sg

PROP

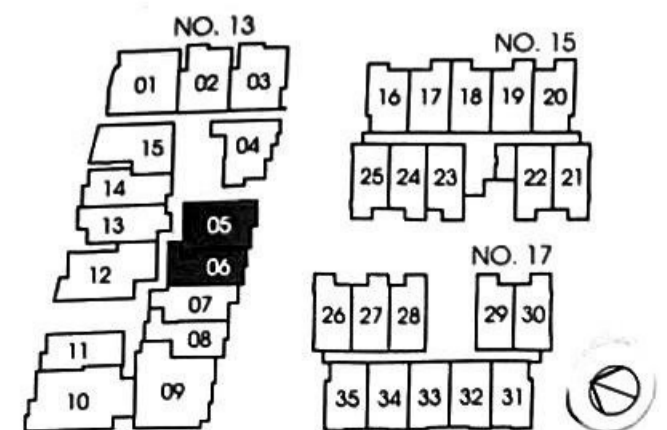

TYPE 2-A12

Unit #05-06
Area 74 sqm / 797 sqft

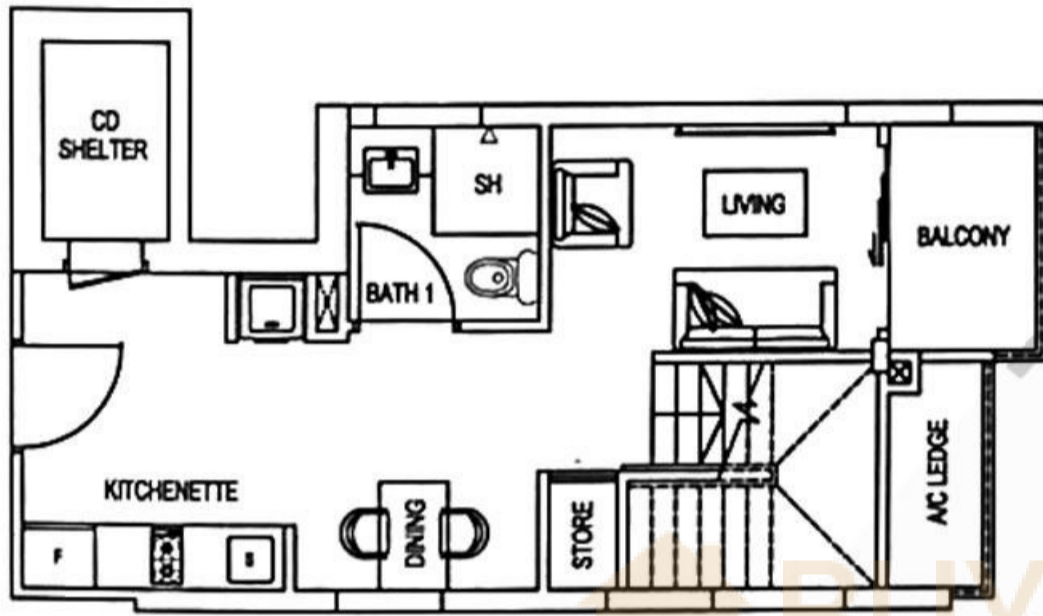

LOWER STOREY

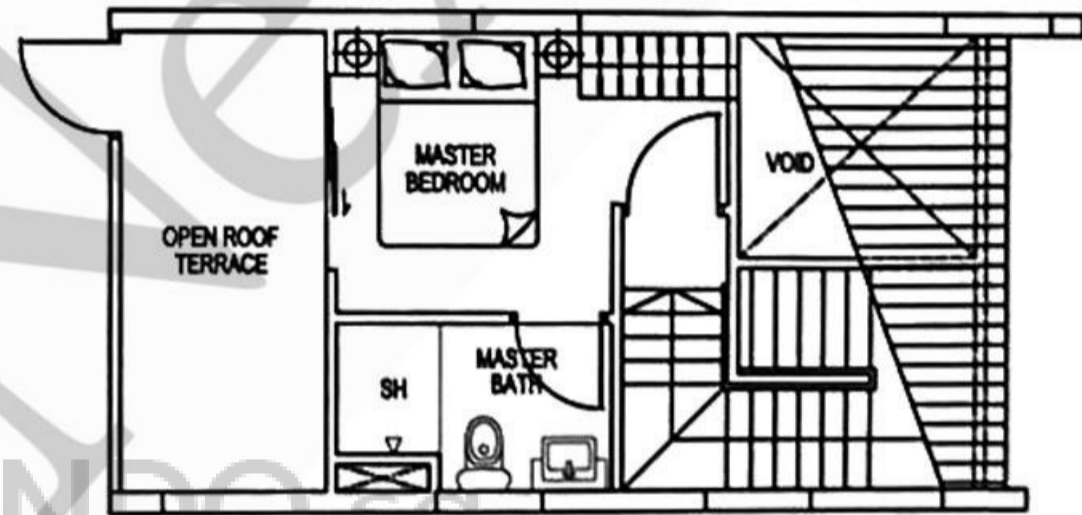

UPPER STOREY

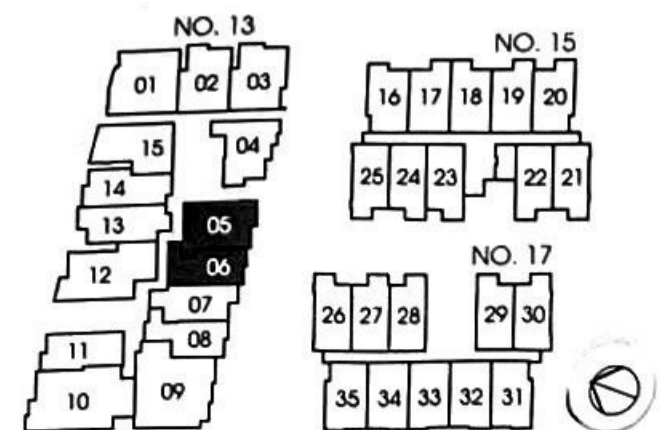

TYPE 2-A13

Unit #05-07
Area 73 sqm / 786 sqft

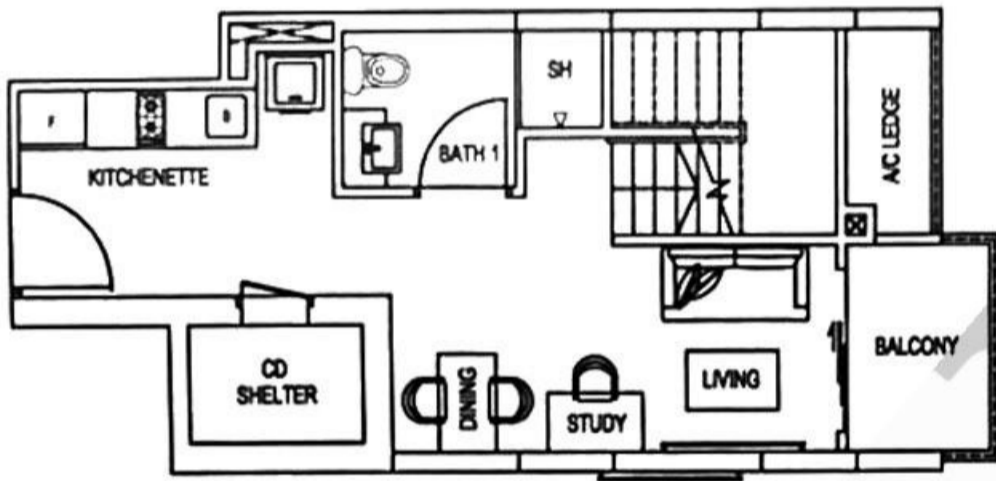

LOWER STOREY

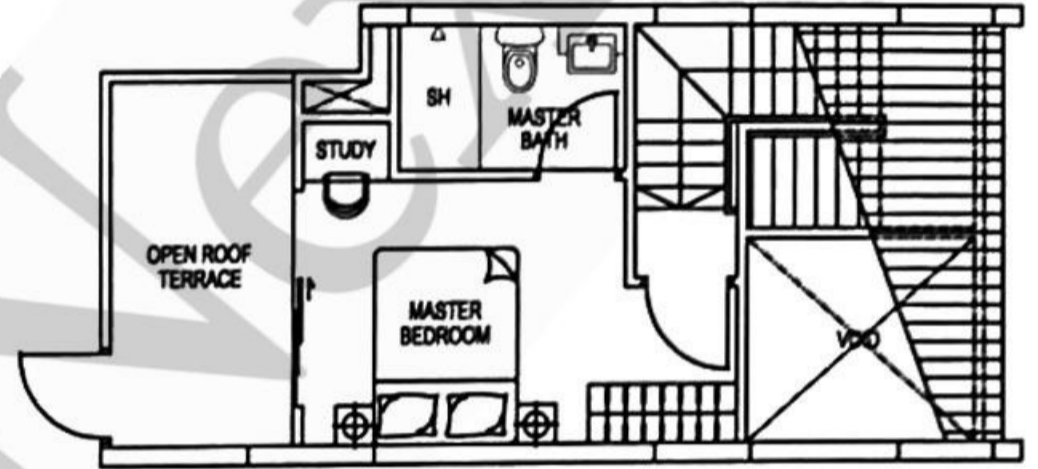

UPPER STOREY

BUYCONDO.sg

PROPT

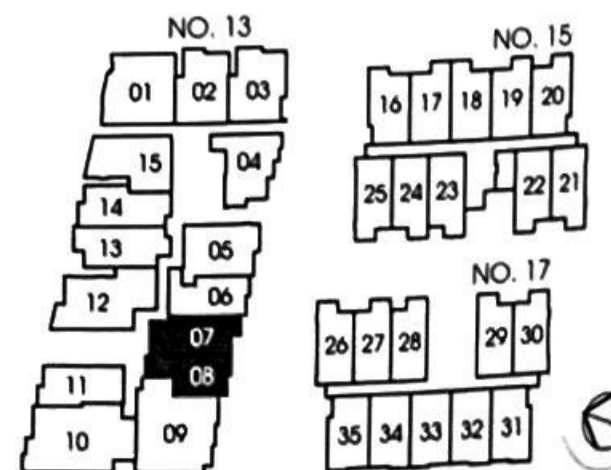

TYPE 2-A14

Unit #05-08
Area 78 sqm / 840 sqft

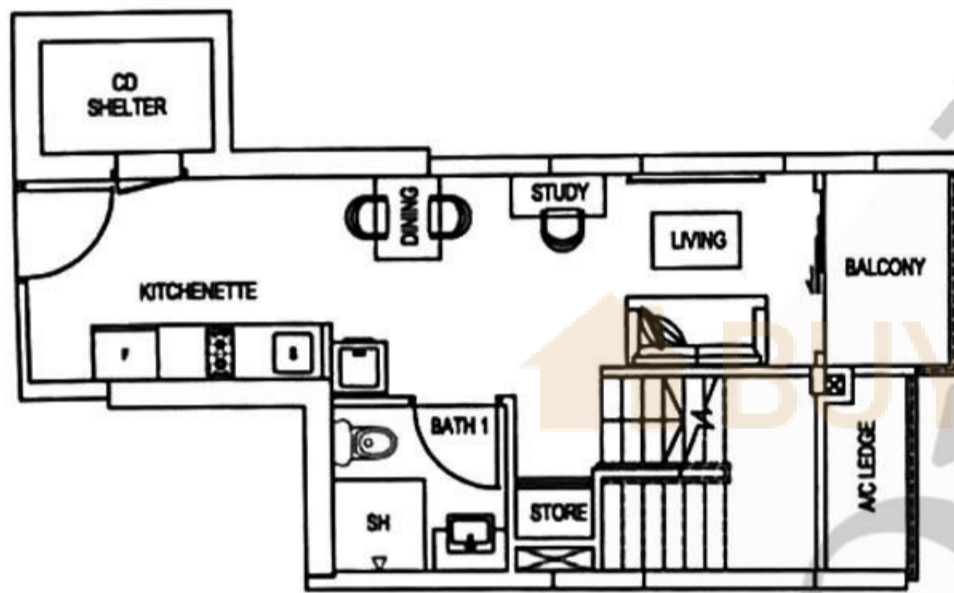

LOWER STOREY

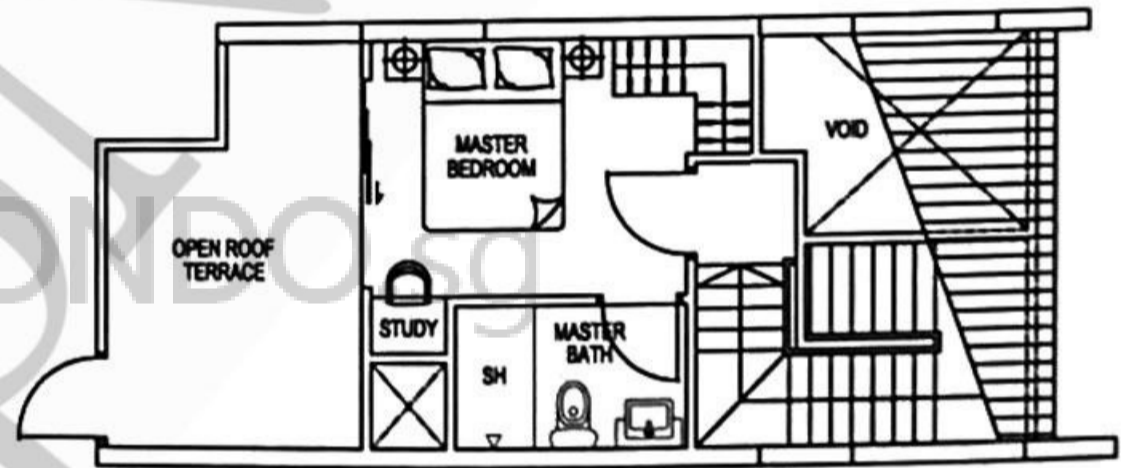

UPPER STOREY

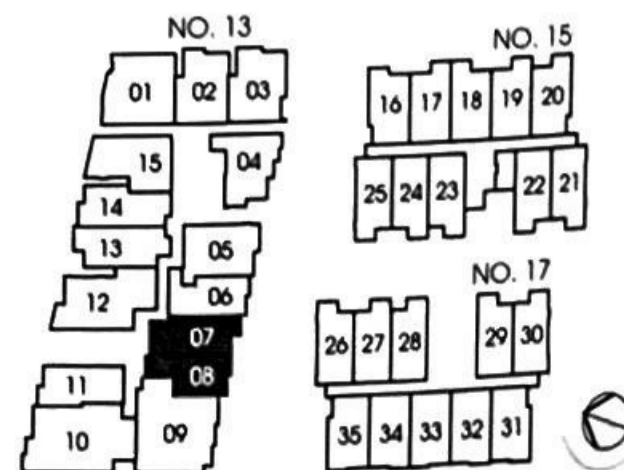

TYPE 2-A15

Unit #05-09
 Area 143 sqm / 1539 sqft

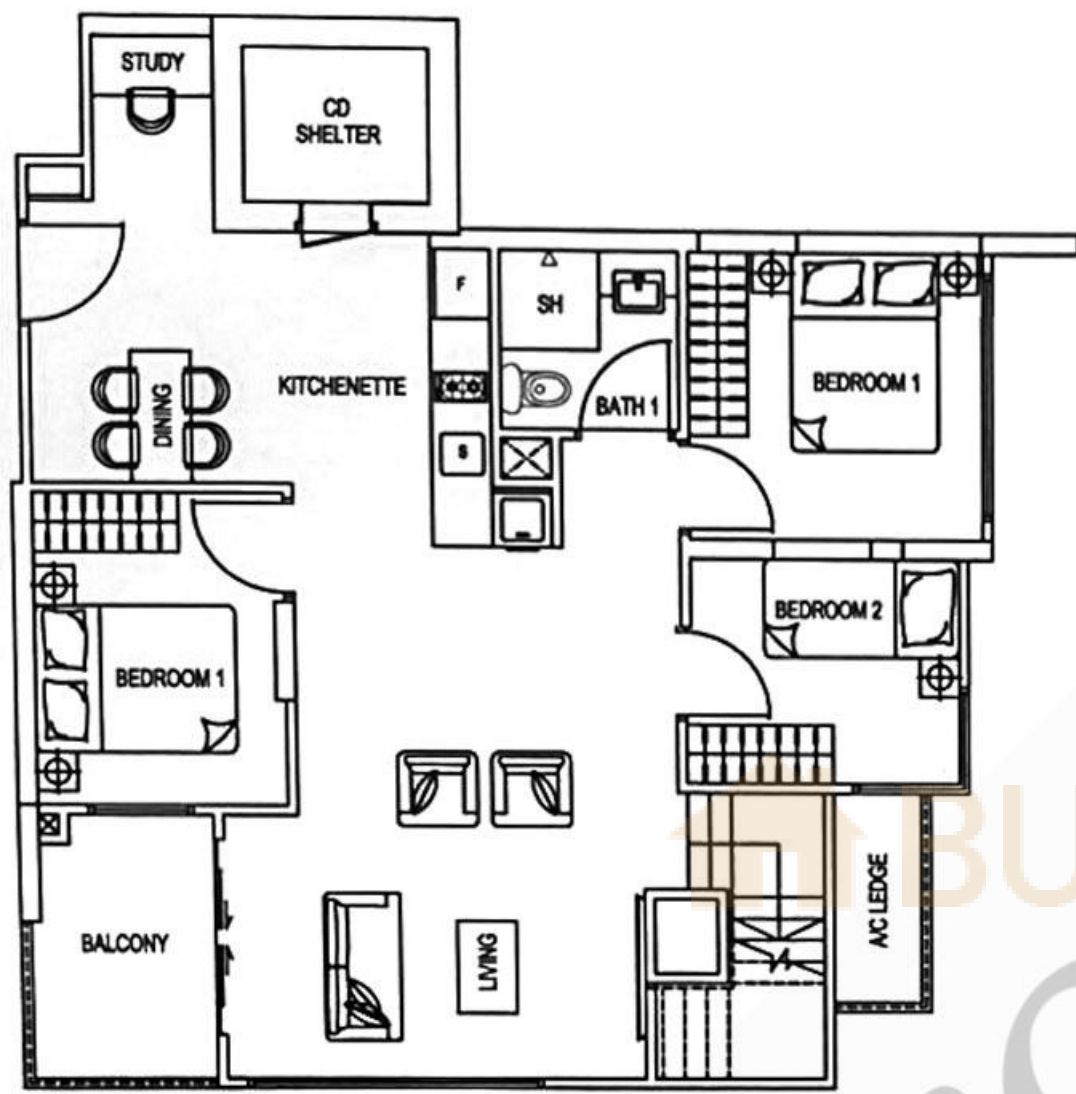

LOWER STOREY

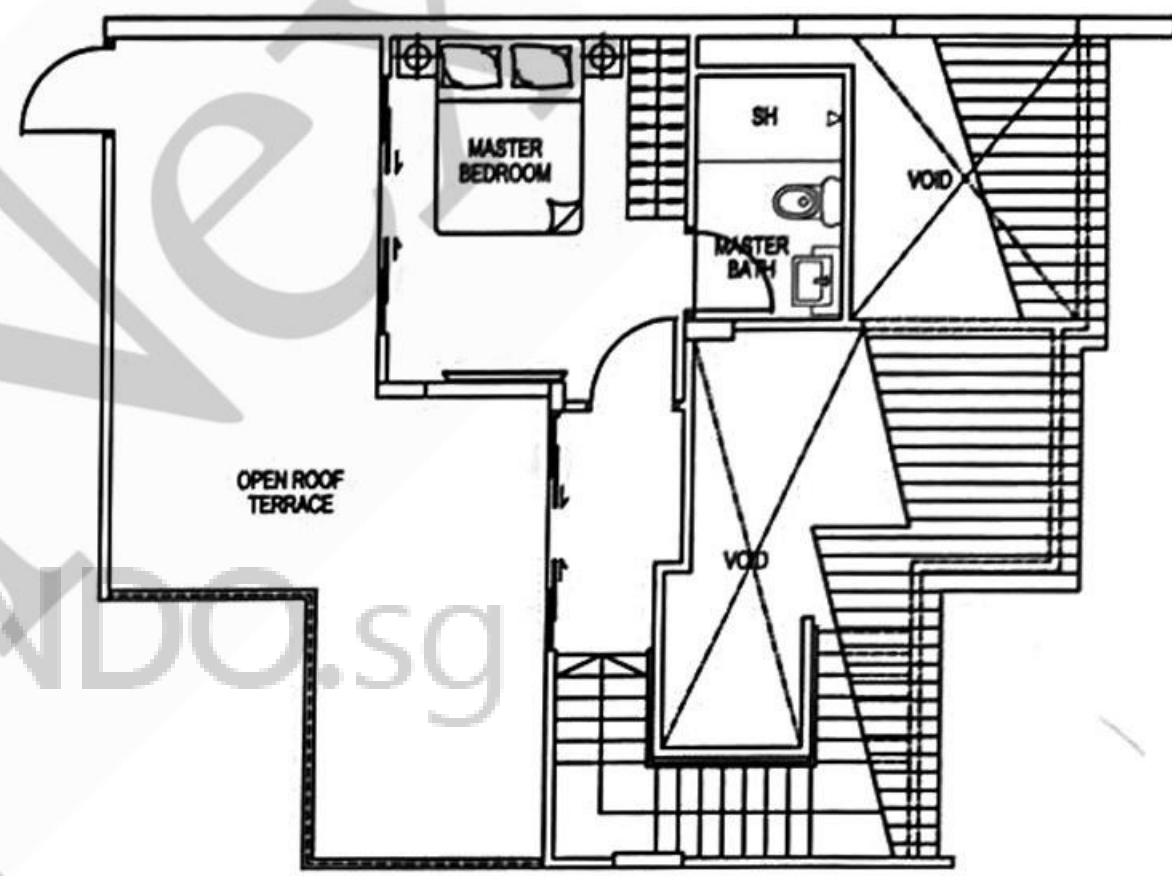

UPPER STOREY

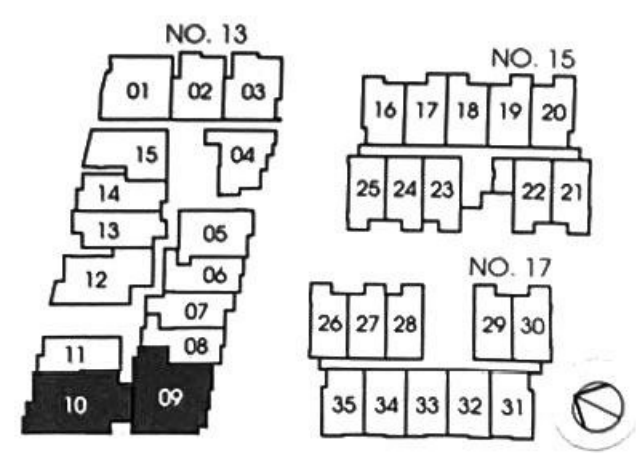

TYPE 2-B1

Unit #05-35
Area 83 sqm / 893 sqft

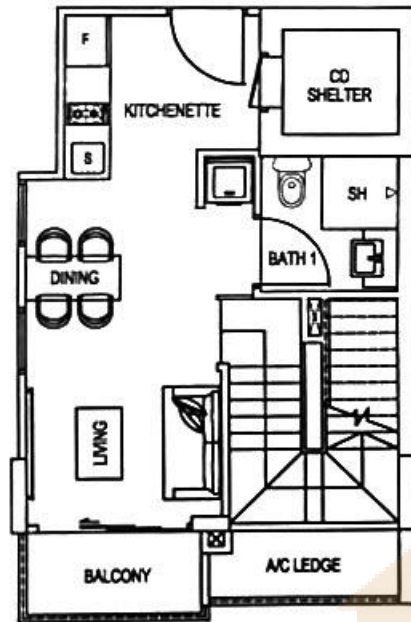

LOWER STOREY

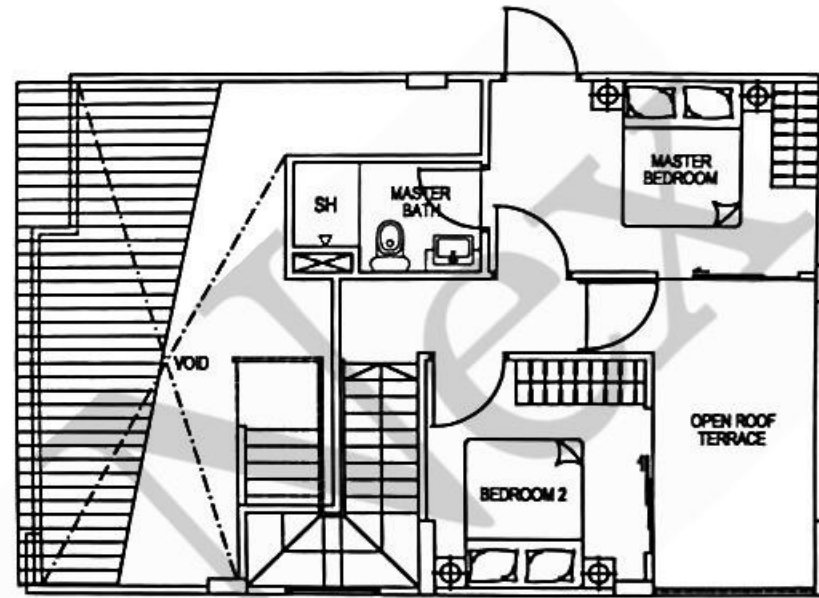

UPPER STOREY

BUY CONDO.sg

PROPT

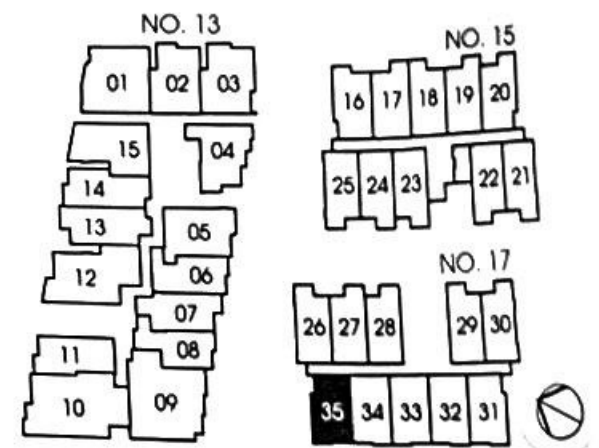

TYPE 2 -B3

Unit #05-33

Area 77 sqm / 829 sqft

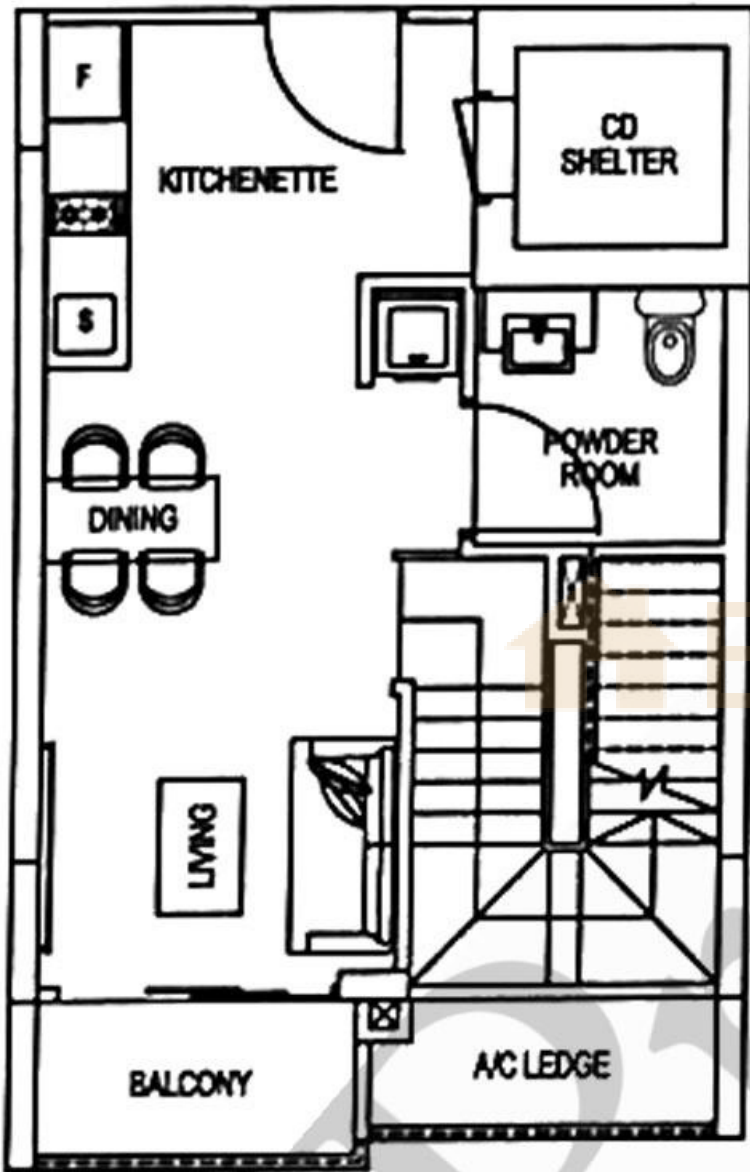

LOWER STOREY

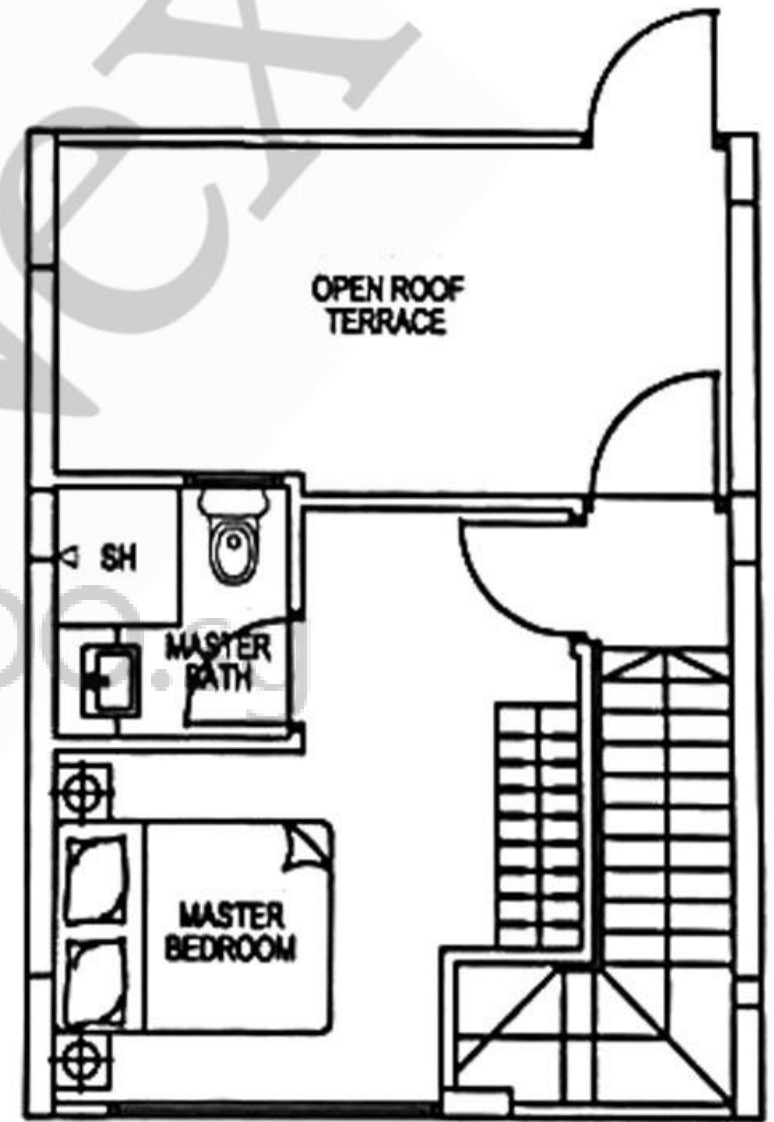

UPPER STOREY

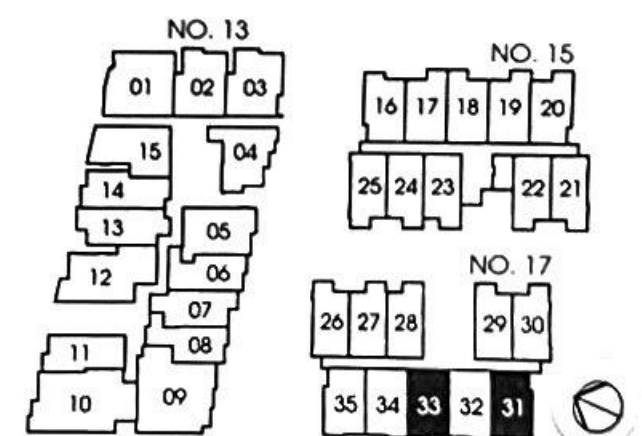

TYPE 2-B4

Unit #05-31

Area 83 sqm / 893 sqft

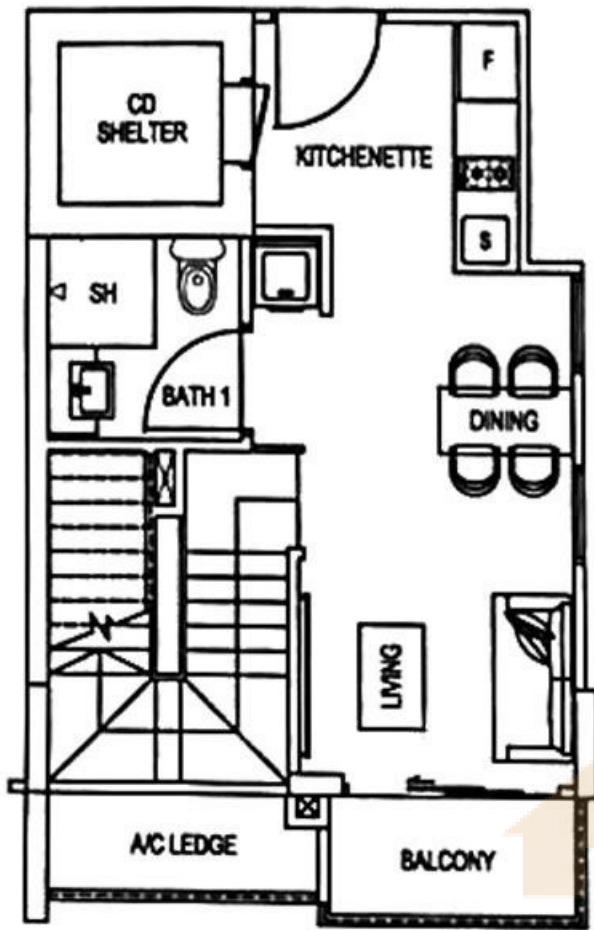

LOWER STOREY

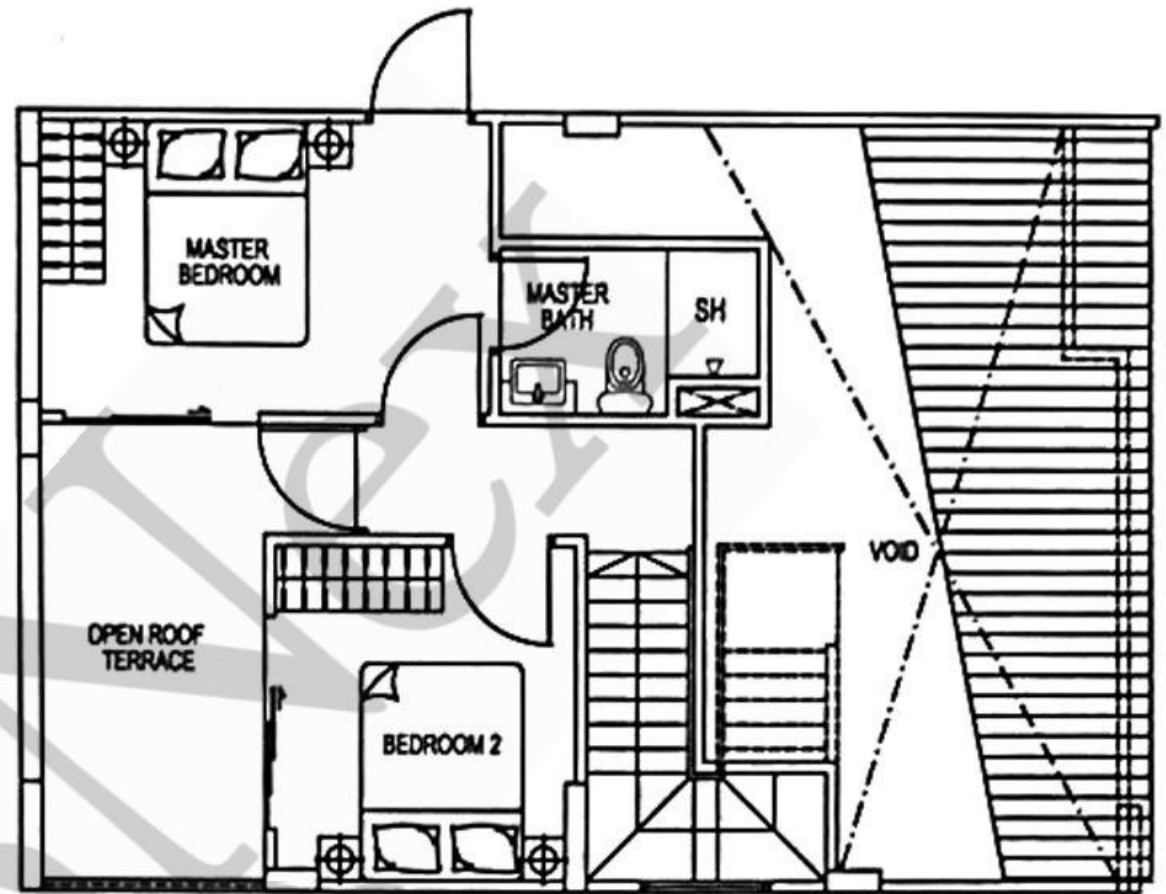

UPPER STOREY

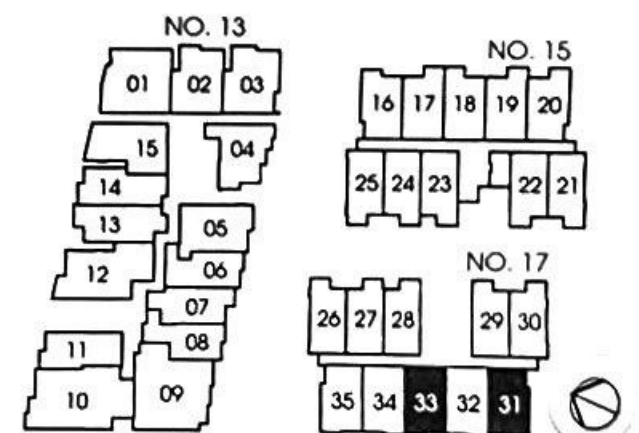

TYPE 2-B6

Unit #05-29
 Area 84 sqm / 904 sqft

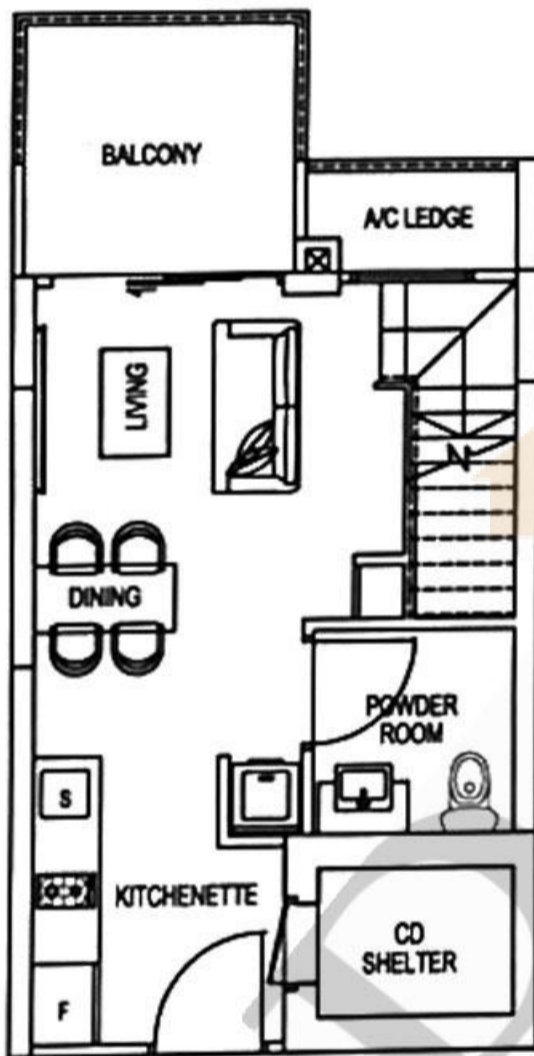

LOWER STOREY

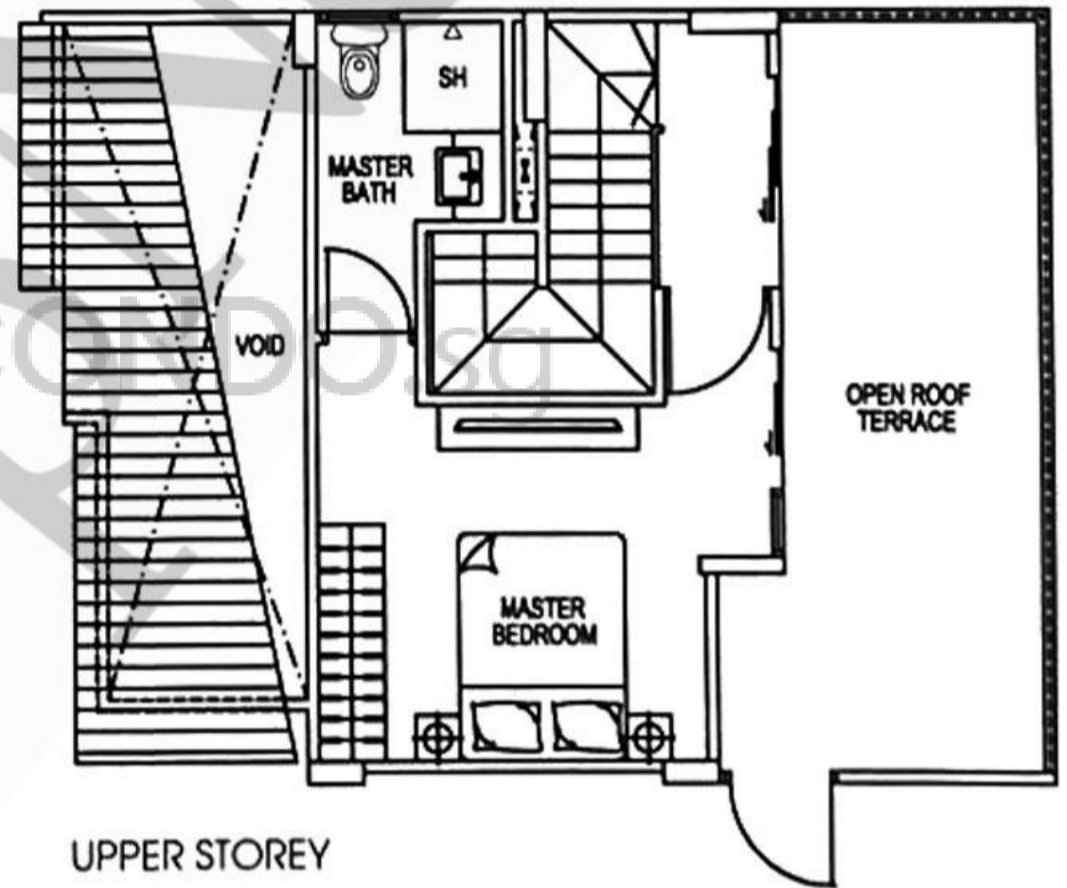

UPPER STOREY

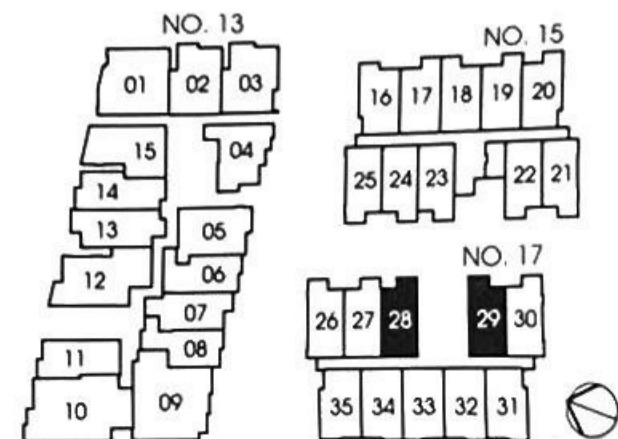

TYPE 2-B7

Unit #05-28
Area 107 sqm / 1152 sqft

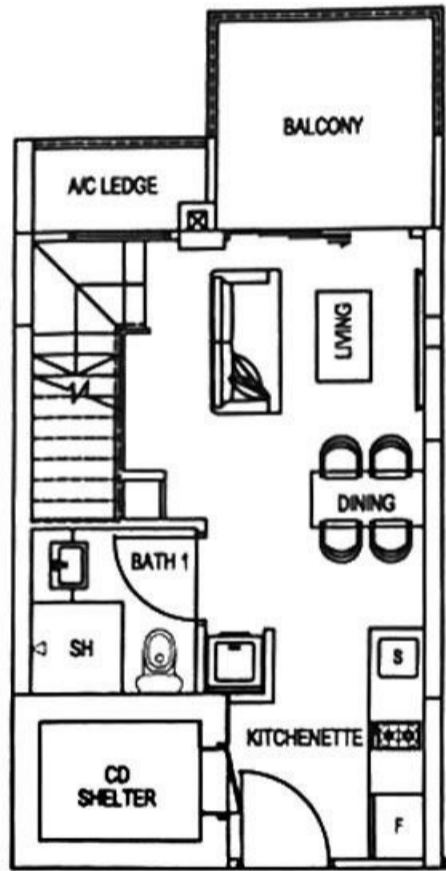

LOWER STOREY

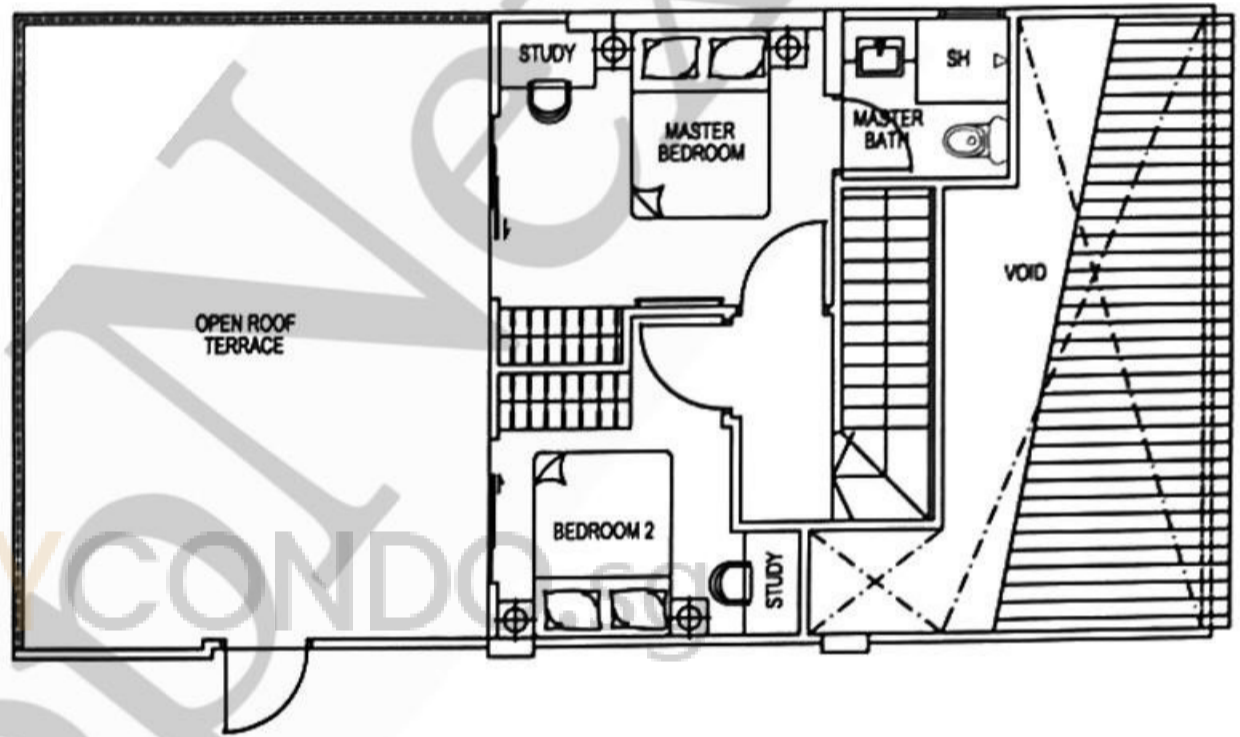

UPPER STOREY

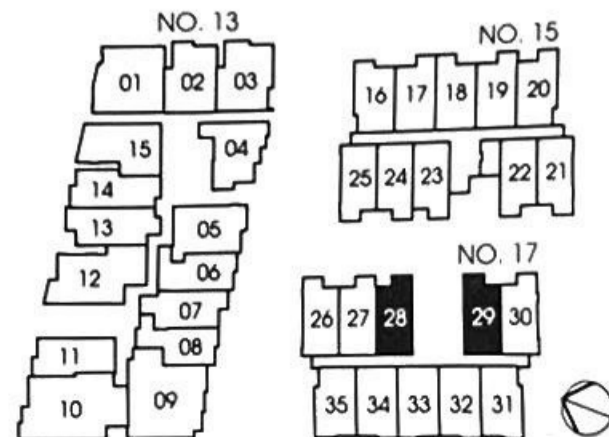

TYPE 2-C1

Unit #05-20

Area 86 sqm / 926 sqft



LOWER STOREY

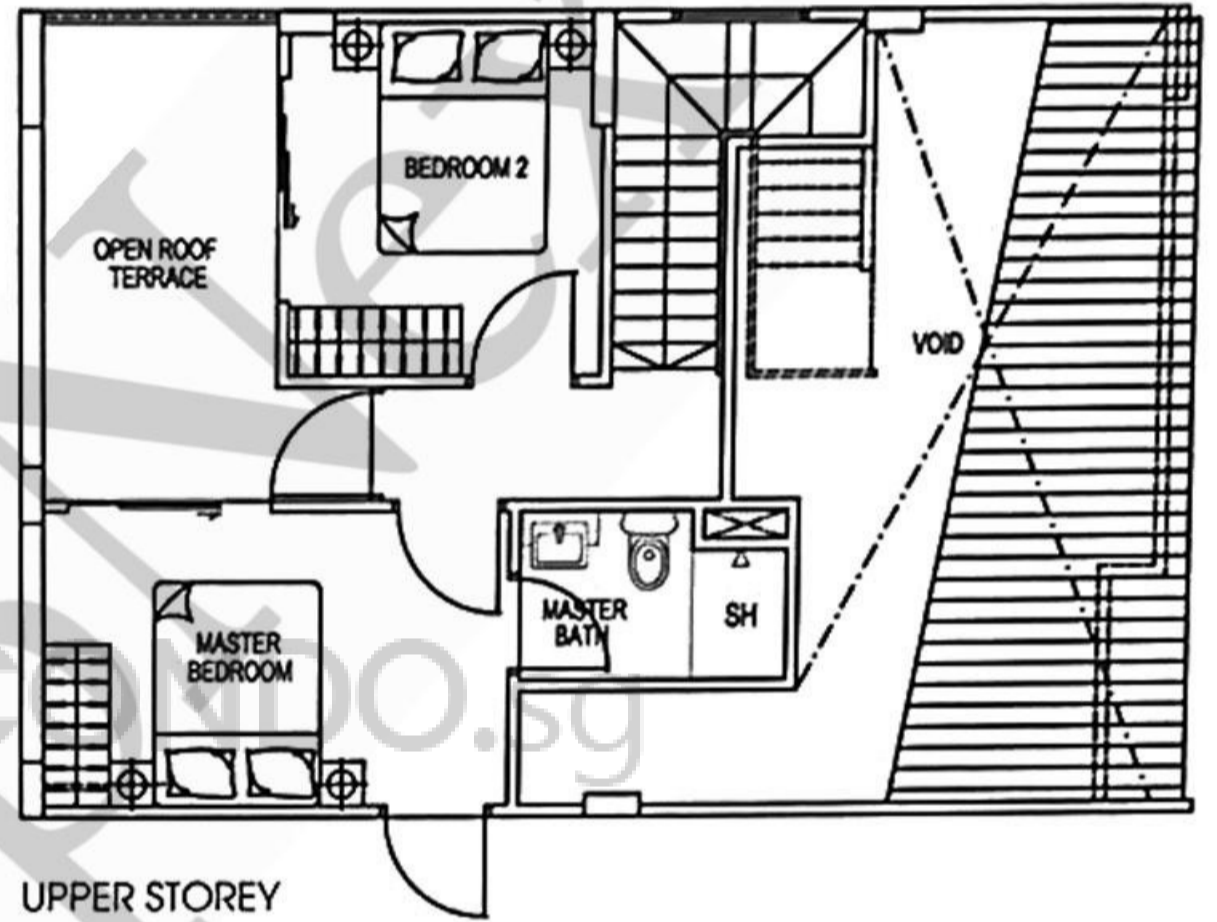

UPPER STOREY

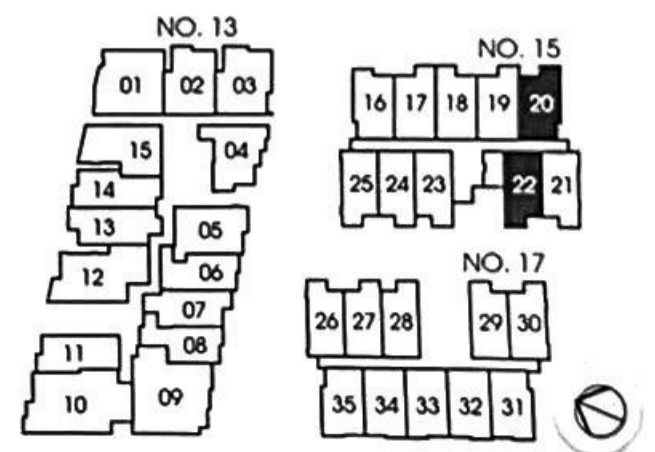

TYPE 2-C3

Unit #05-18
Area 79 sqm / 850 sqft

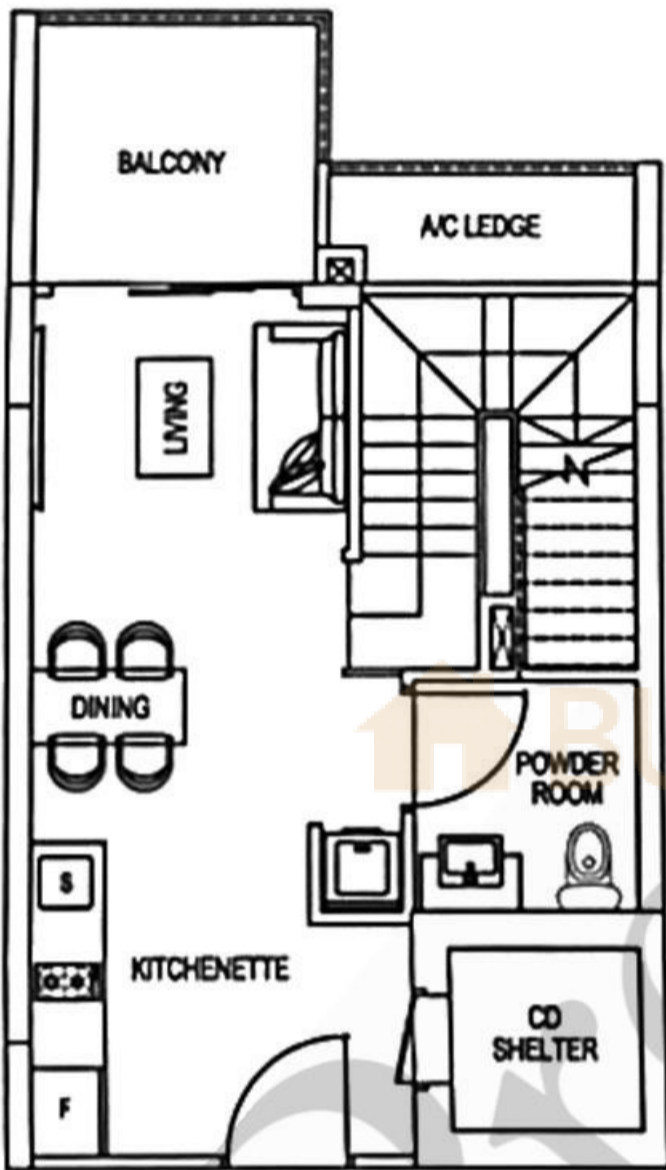

LOWER STOREY

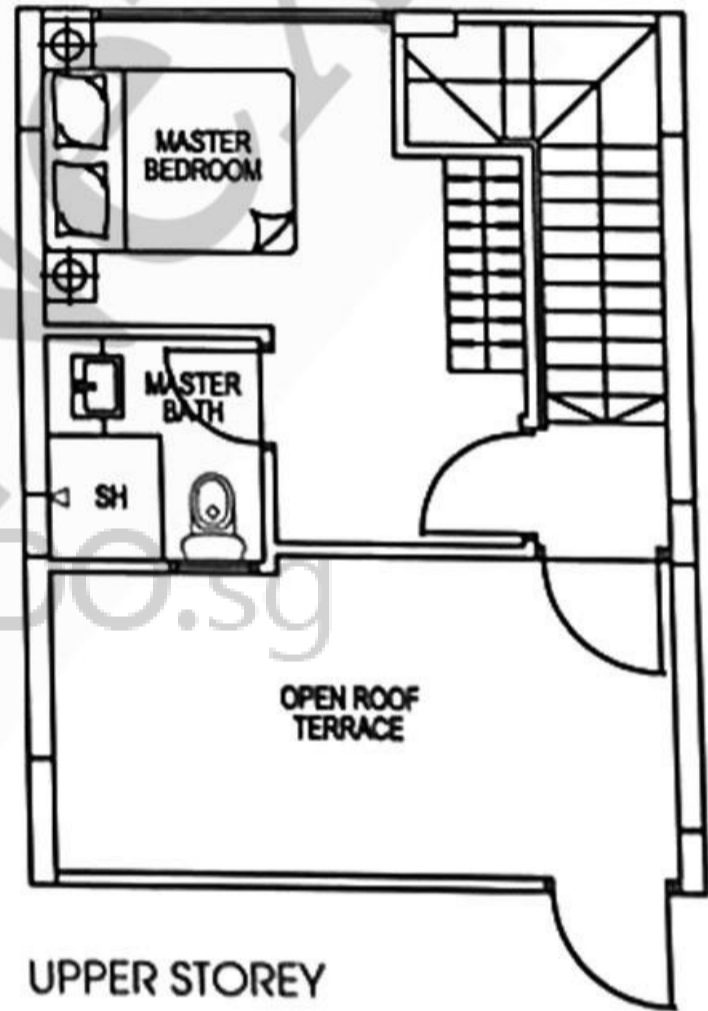

UPPER STOREY

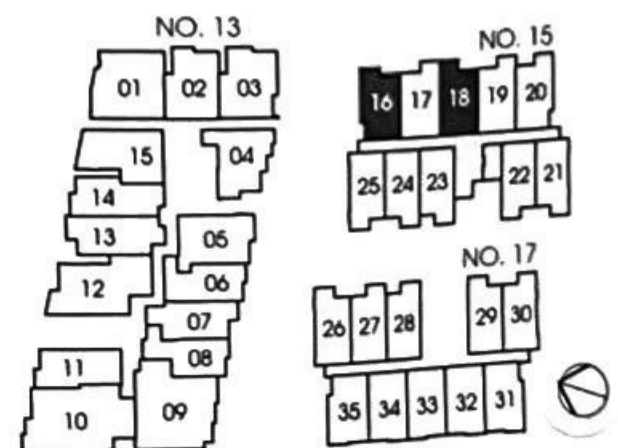

TYPE 2-C4

Unit #05-16
Area 85 sqm / 915 sqft



LOWER STOREY

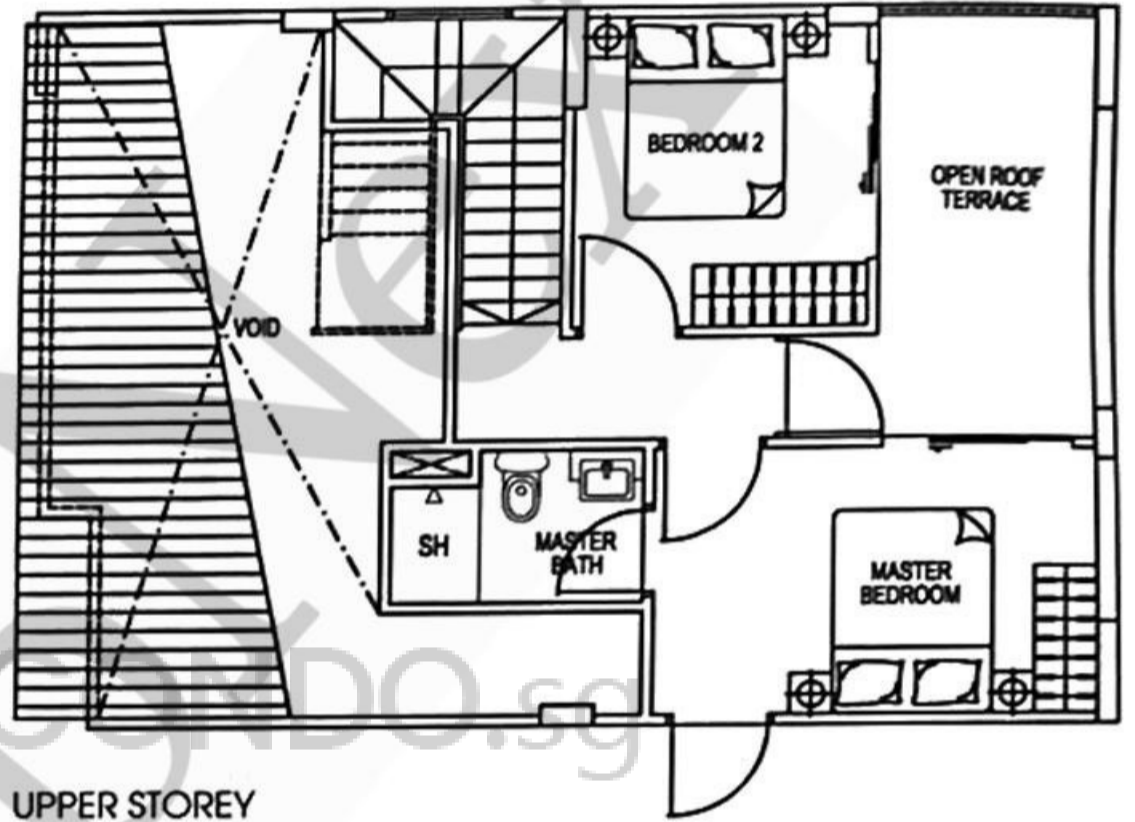

UPPER STOREY

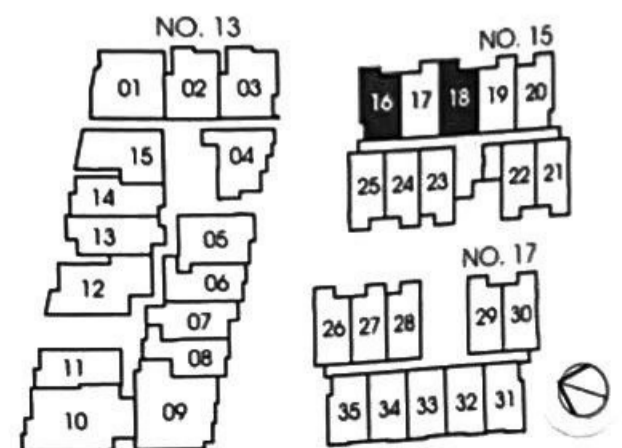

TYPE 2-C6

Unit #05-23

Area 107 sqm / 1152 sqft

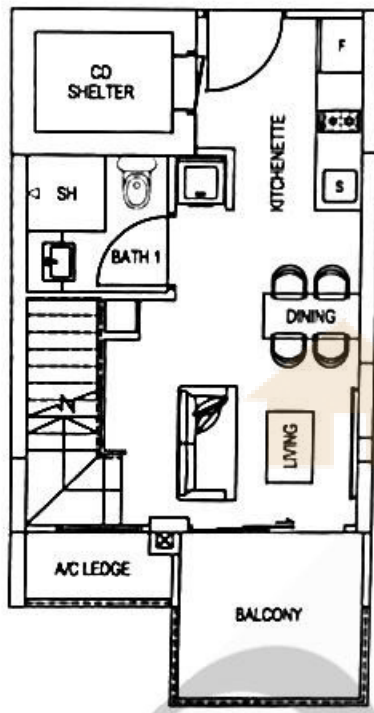

LOWER STOREY

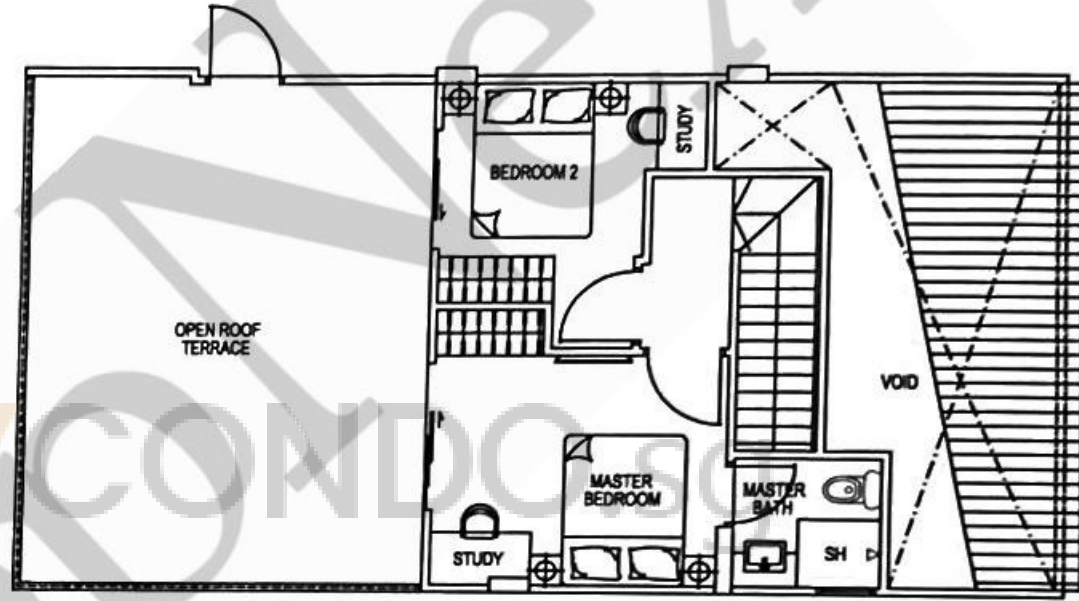

UPPER STOREY

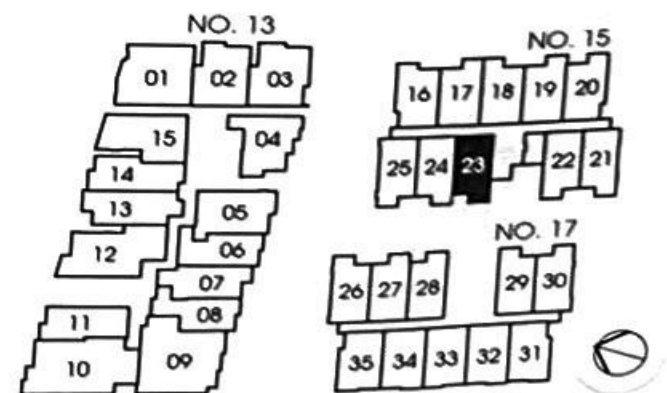

TYPE 2-C7

Unit #05-22
Area 84 sqm / 904 sqft

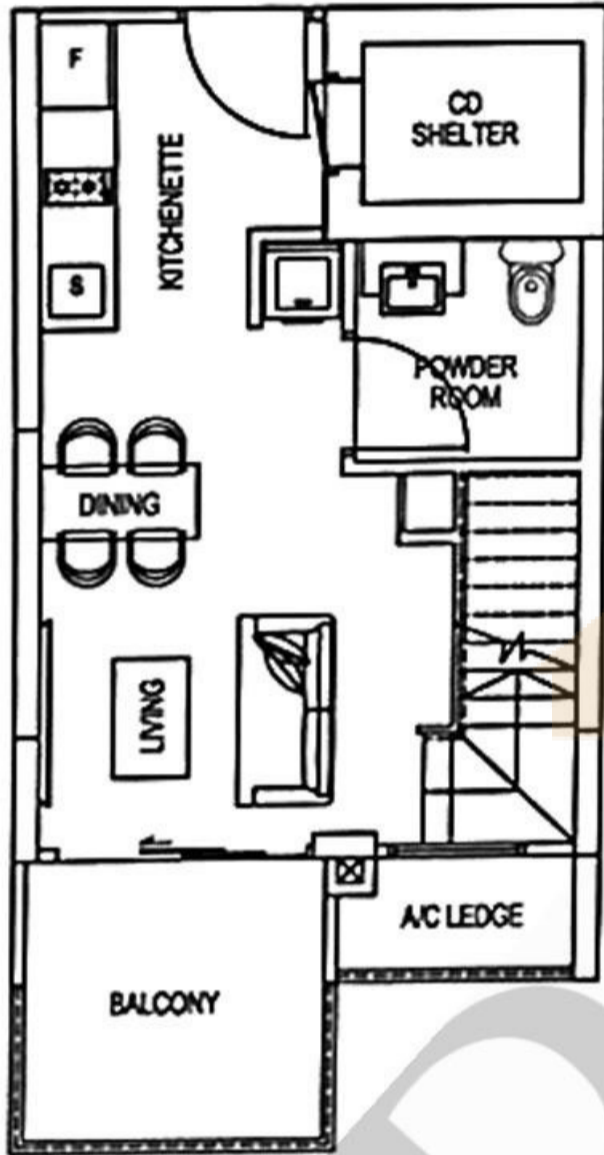

LOWER STOREY

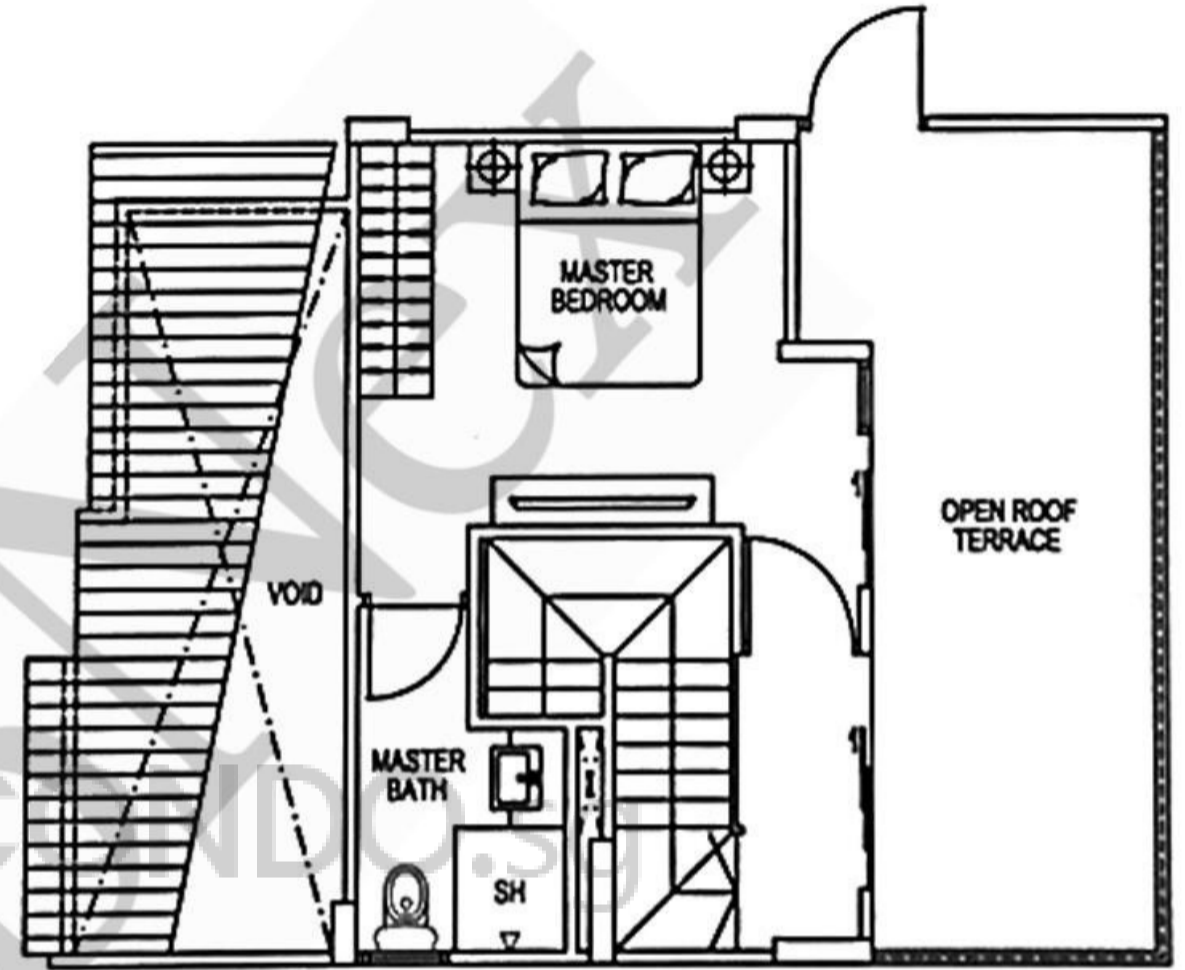

UPPER STOREY

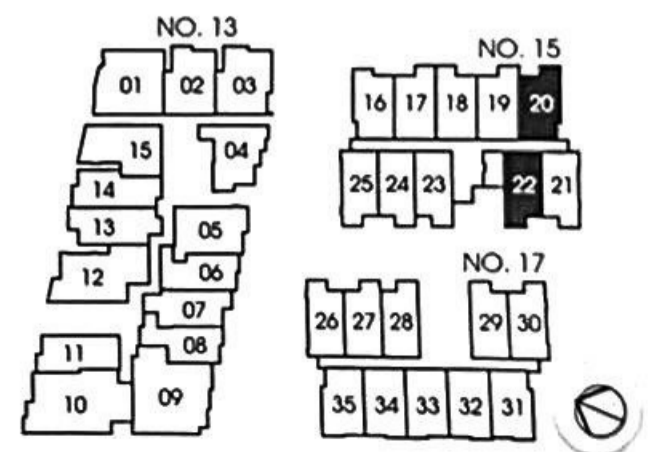

TYPE A10

Unit #02-04, #03-04, #04-04, #05-04

Area 47 sqm / 506 sqft

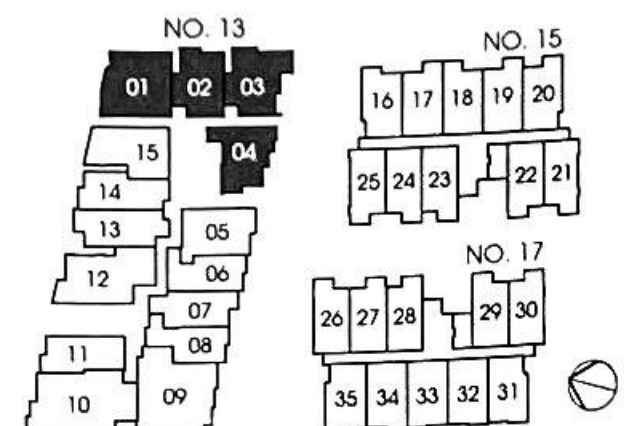
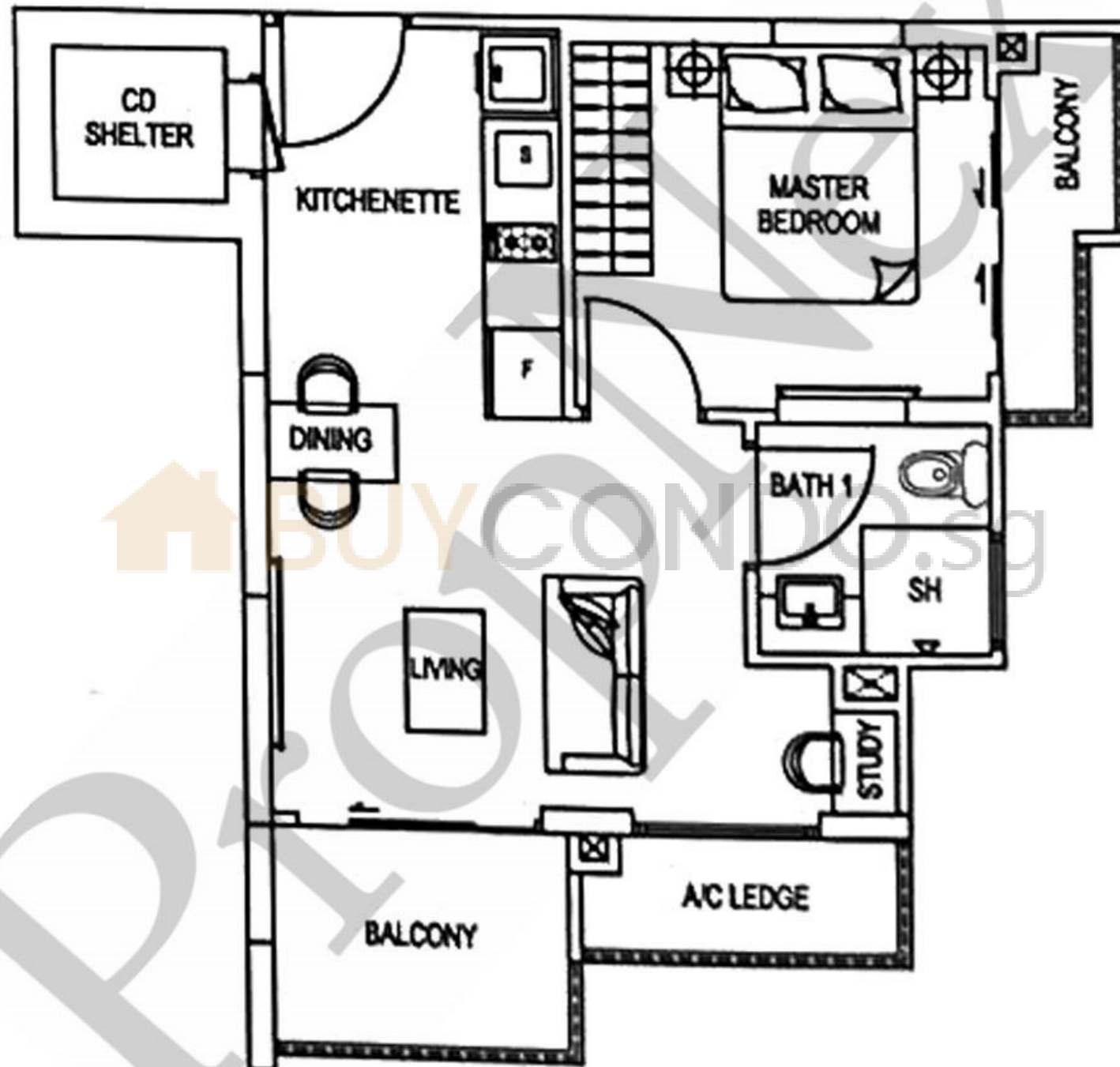

TYPE A1

Units #02-10, #03-10, #04-10

Area 89 sqm / 958 sqft

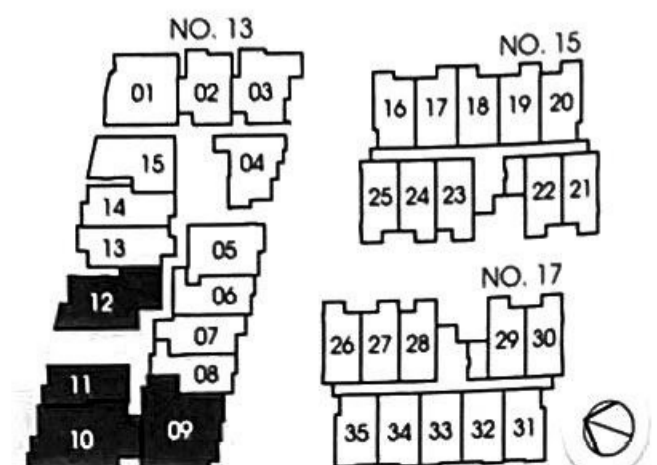
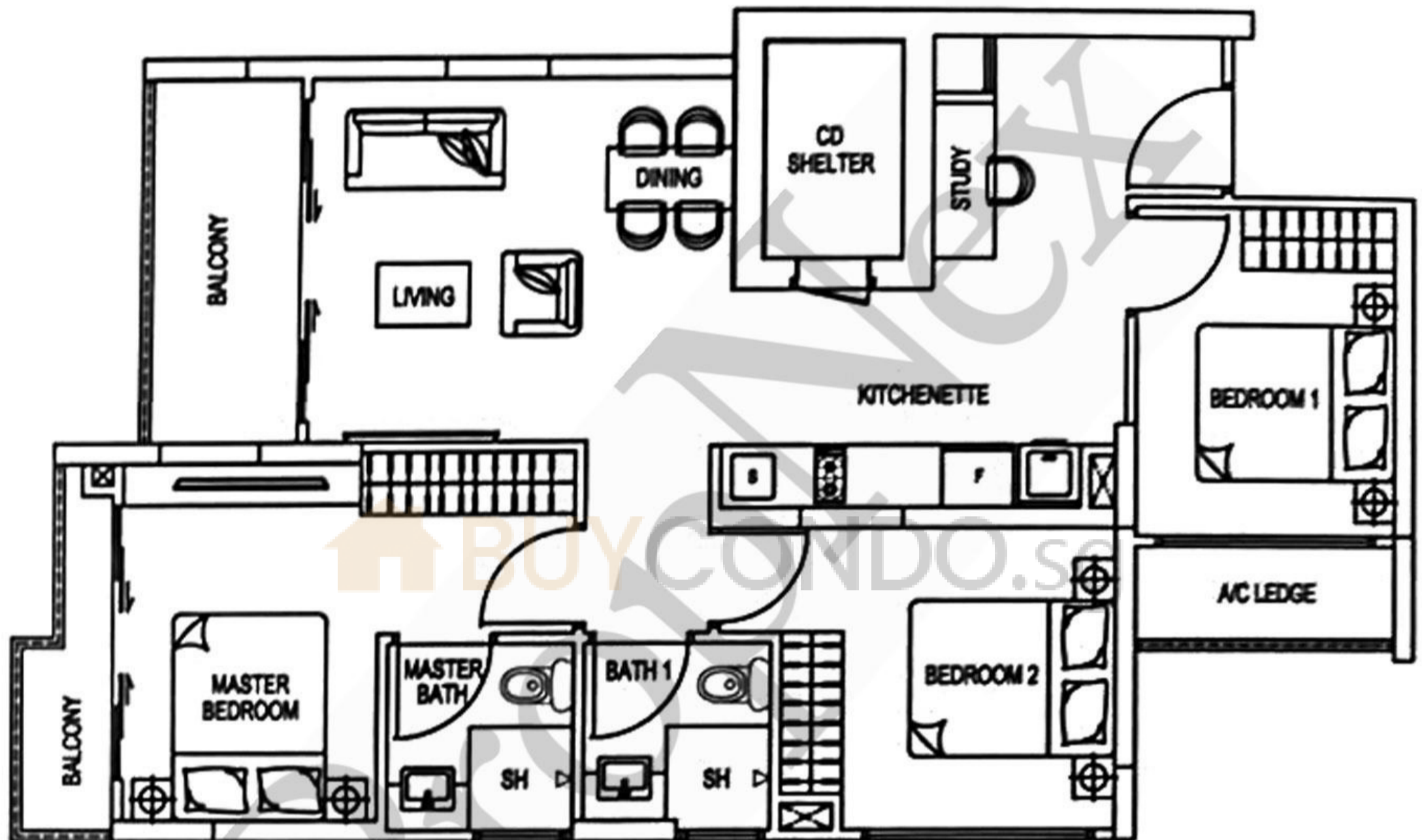

TYPE A2

Unit #02-11, #03-11, #04-11
Area 42 sqm / 452 sqft

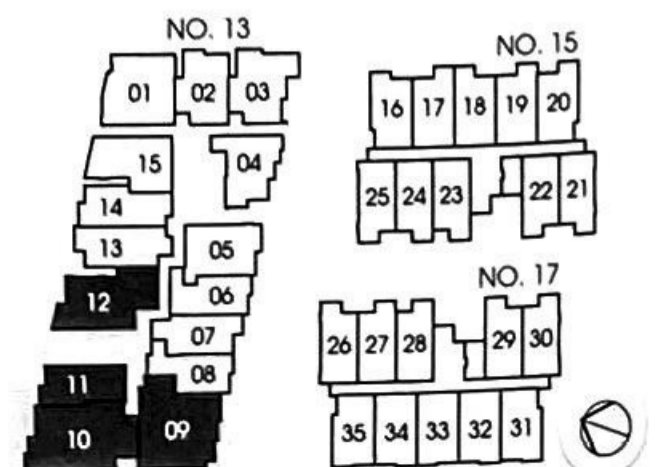
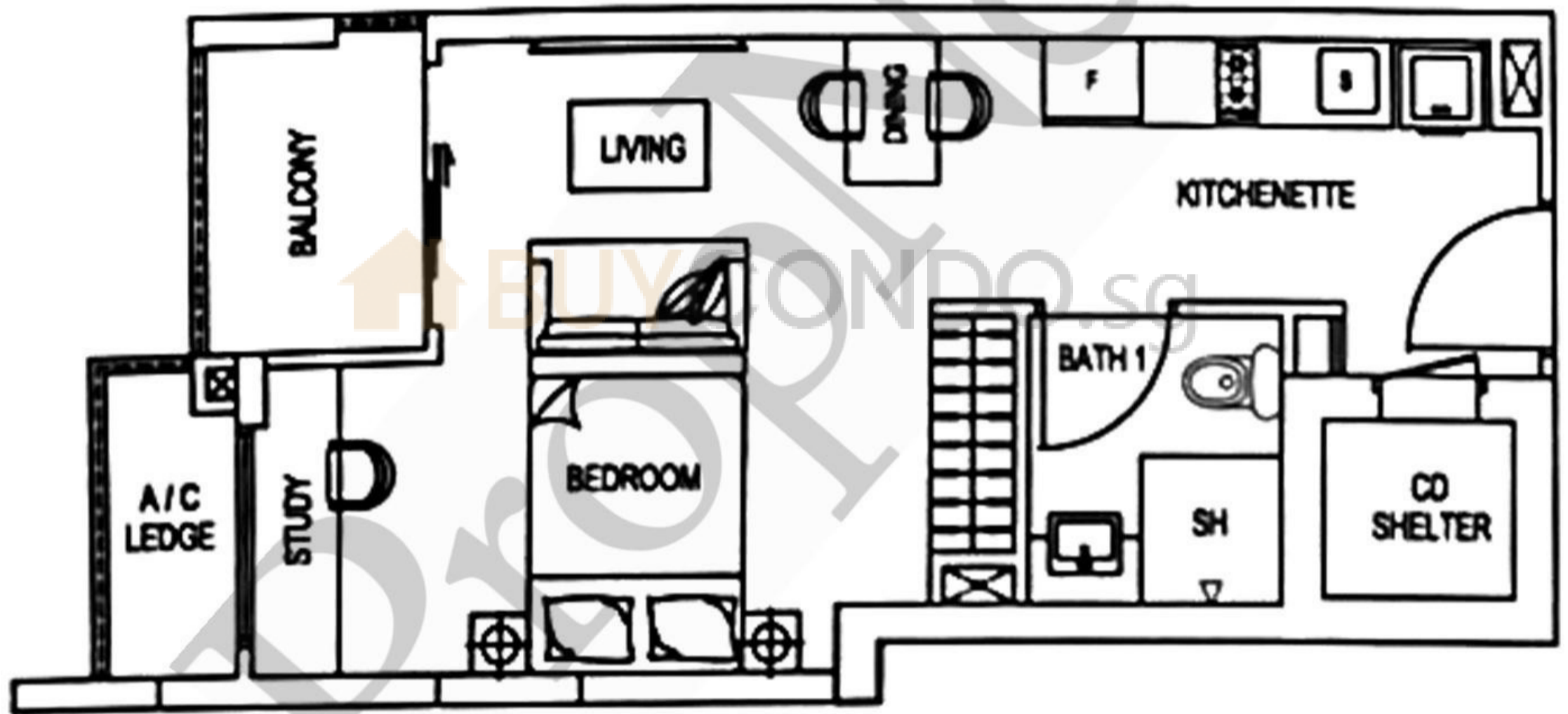

TYPE A3

Unit #02-12, #03-12, #04-12

Area 67 sqm / 721 sqft

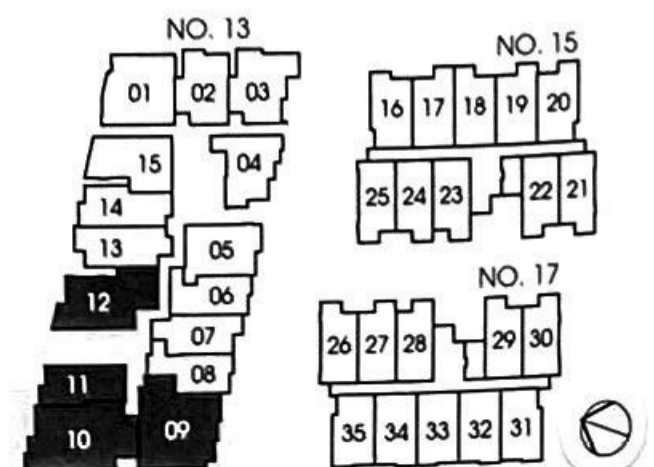
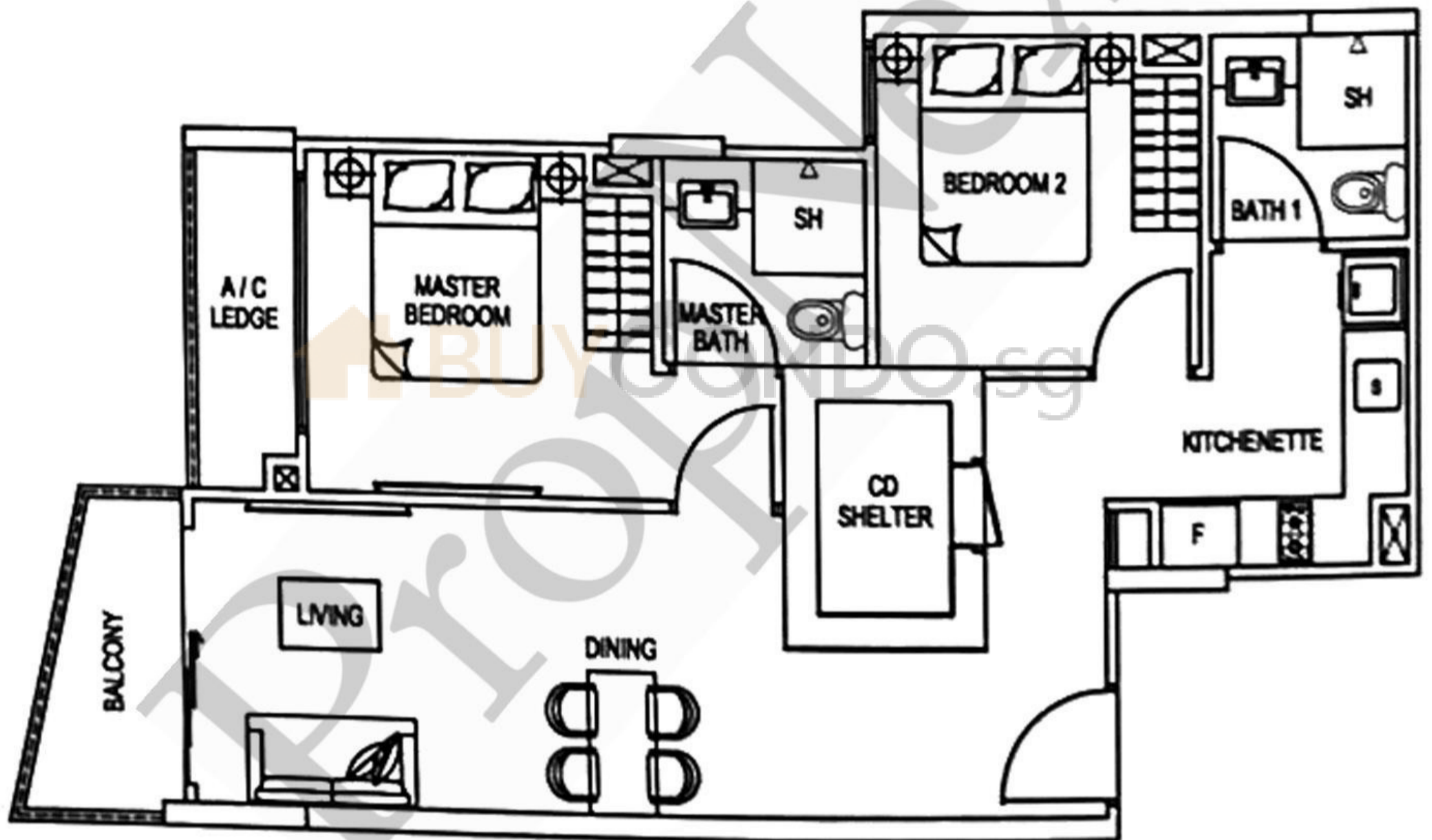

TYPE A4

Unit #02-13, #03-13, #04-13

Area 46 sqm / 495 sqft

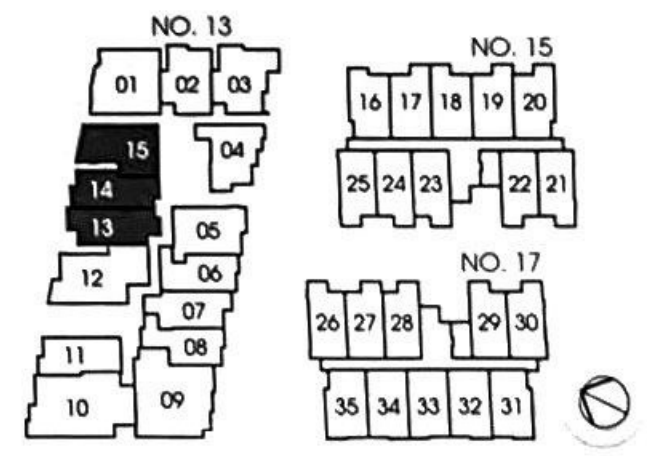
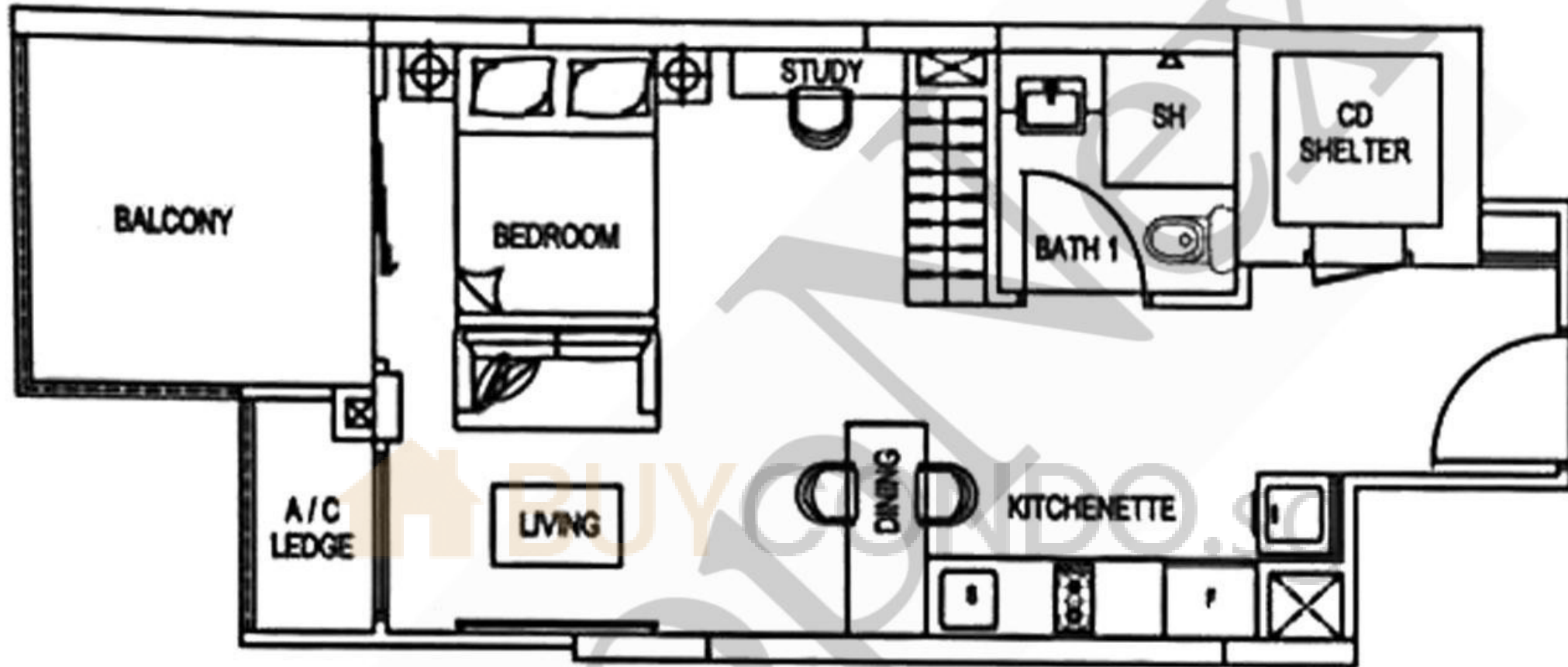

TYPE A5

Unit #02-14, #03-14, #04-14

Area 43 sqm / 463 sqft

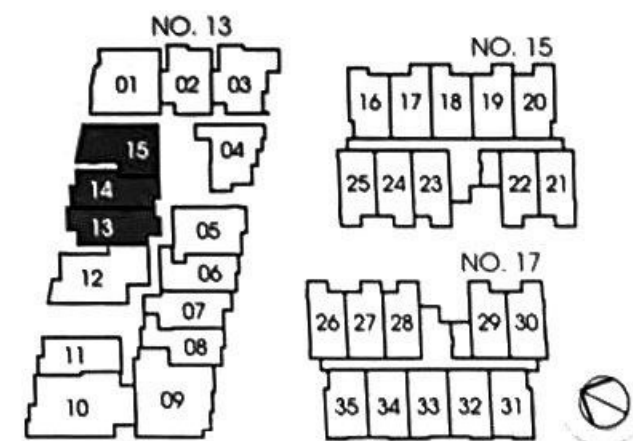
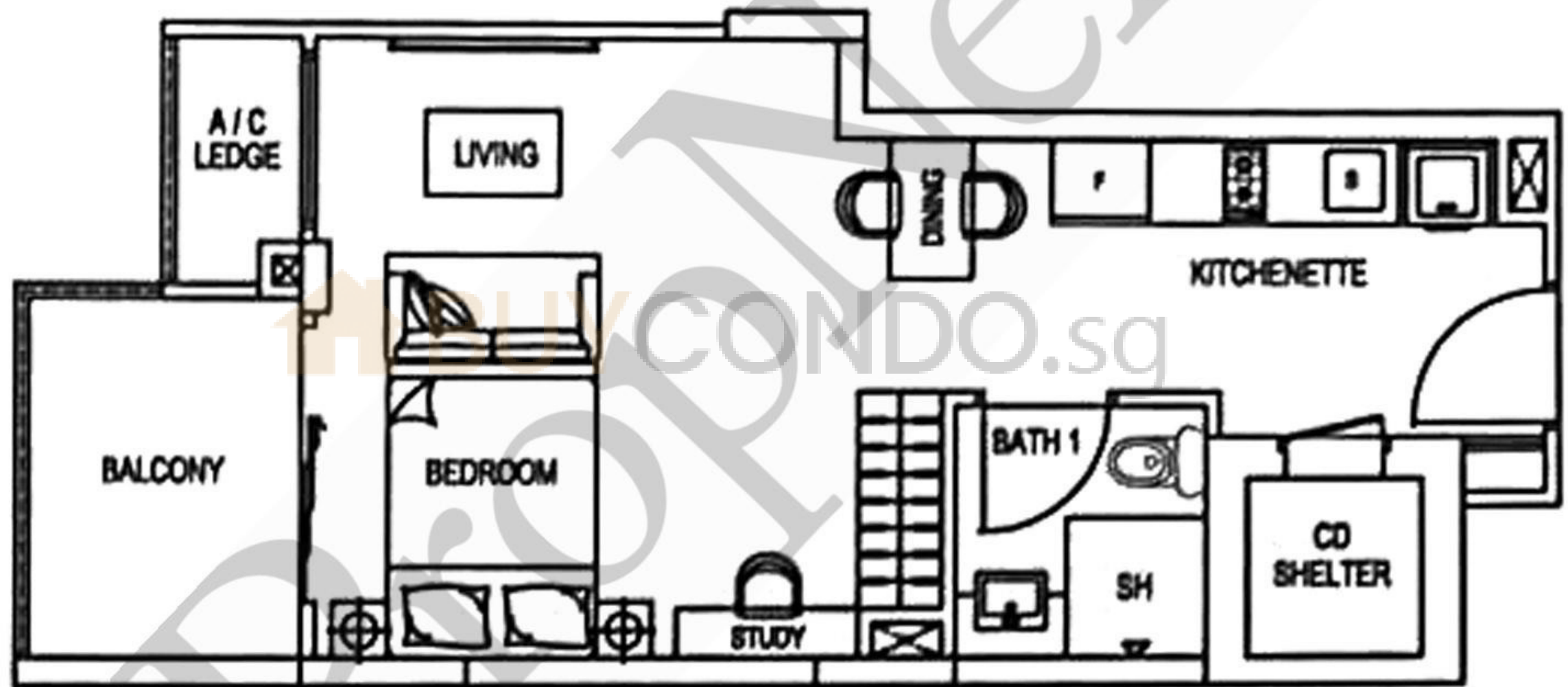

TYPE A6

Unit #02-15, #03-15, #04-15

Area 54 sqm / 581 sqft

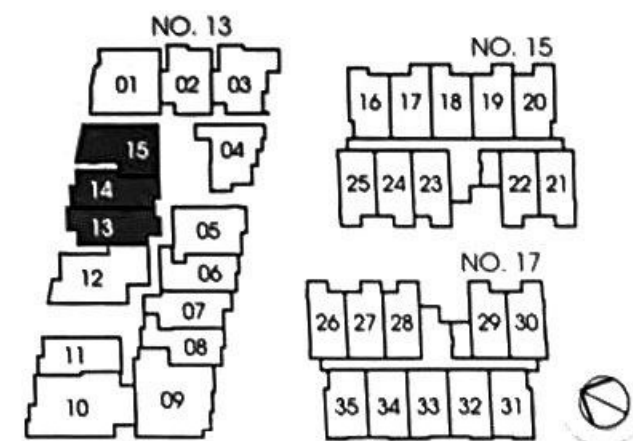
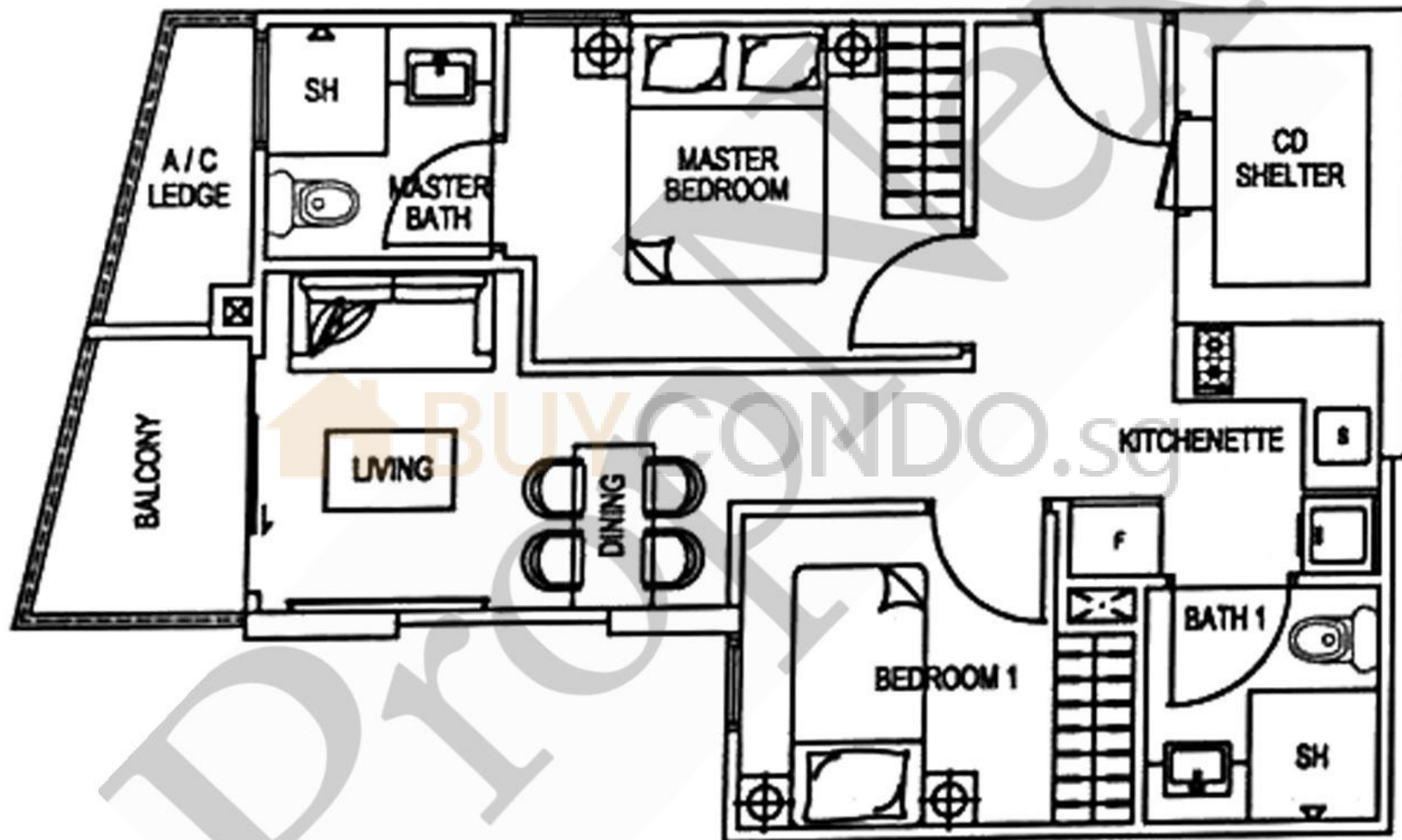

TYPE A7

Unit #02-01, #03-01, #04-01

Area 65 sqm / 700 sqft

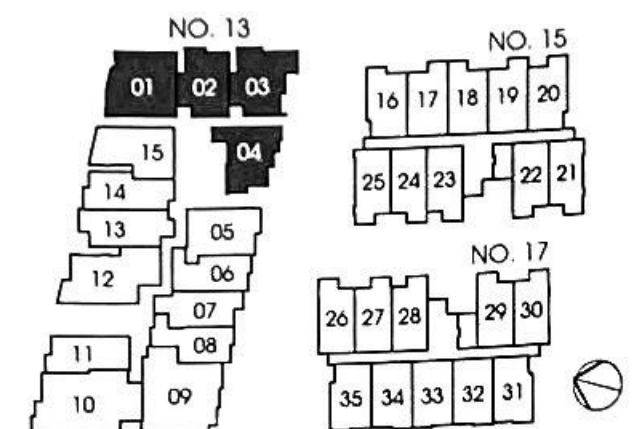
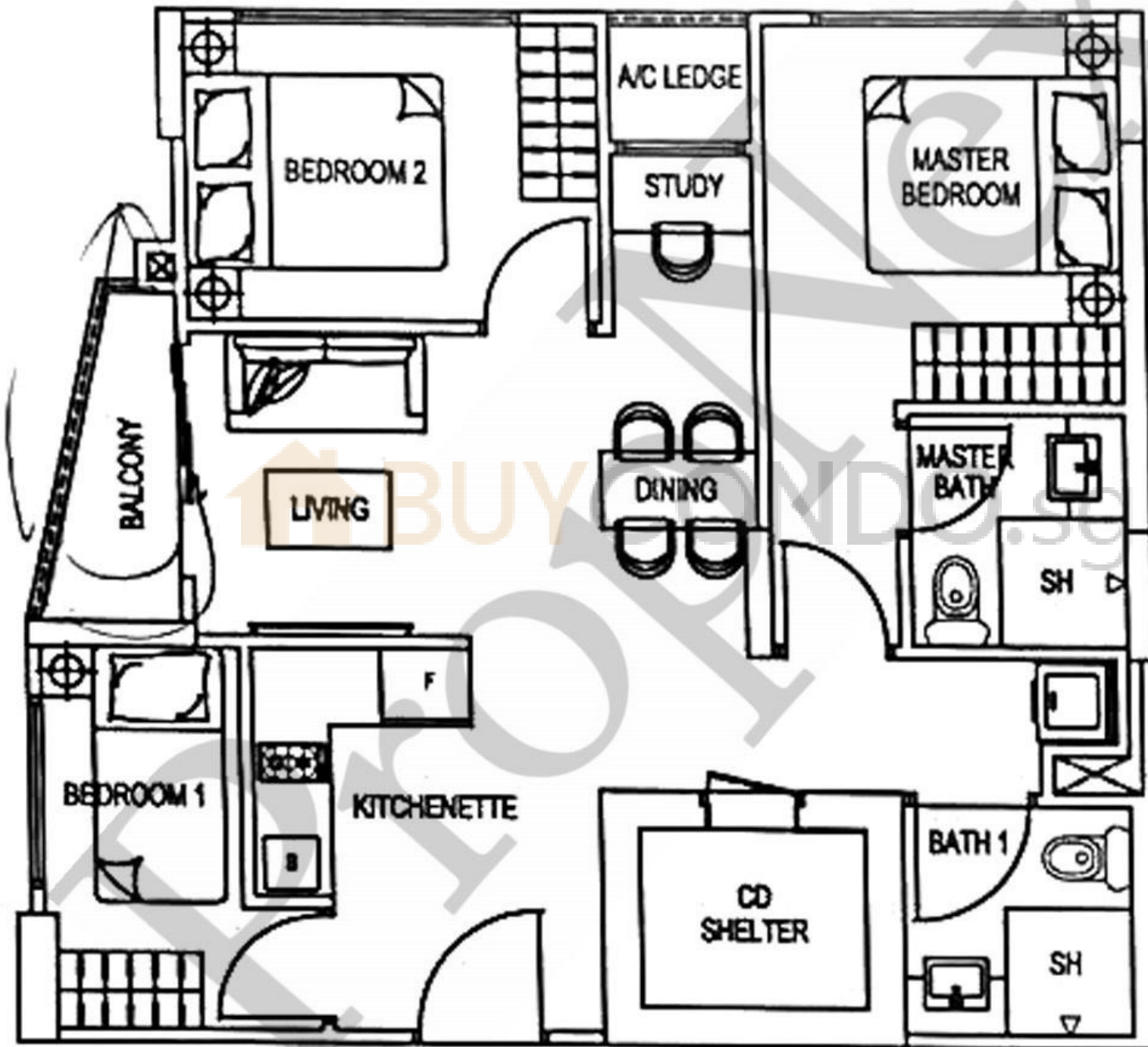

TYPE A8

Unit #02-02, #03-02, #04-02, #05-02
Area 46 sqm / 495 sqft

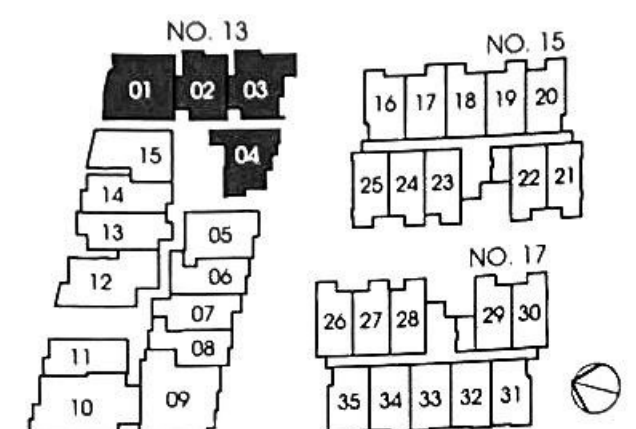

TYPE A9

Unit #02-03, #03-03, #04-03

Area 53 sqm / 570 sqft

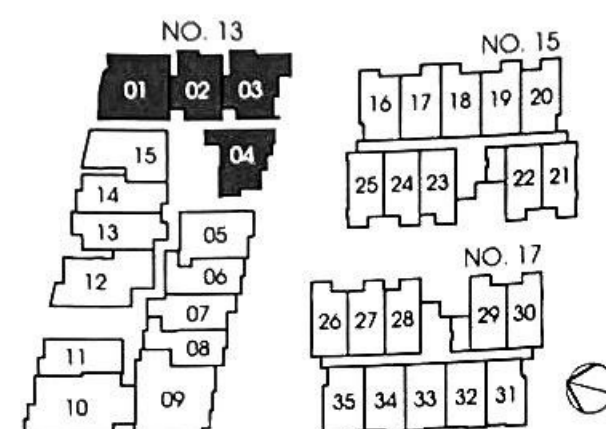
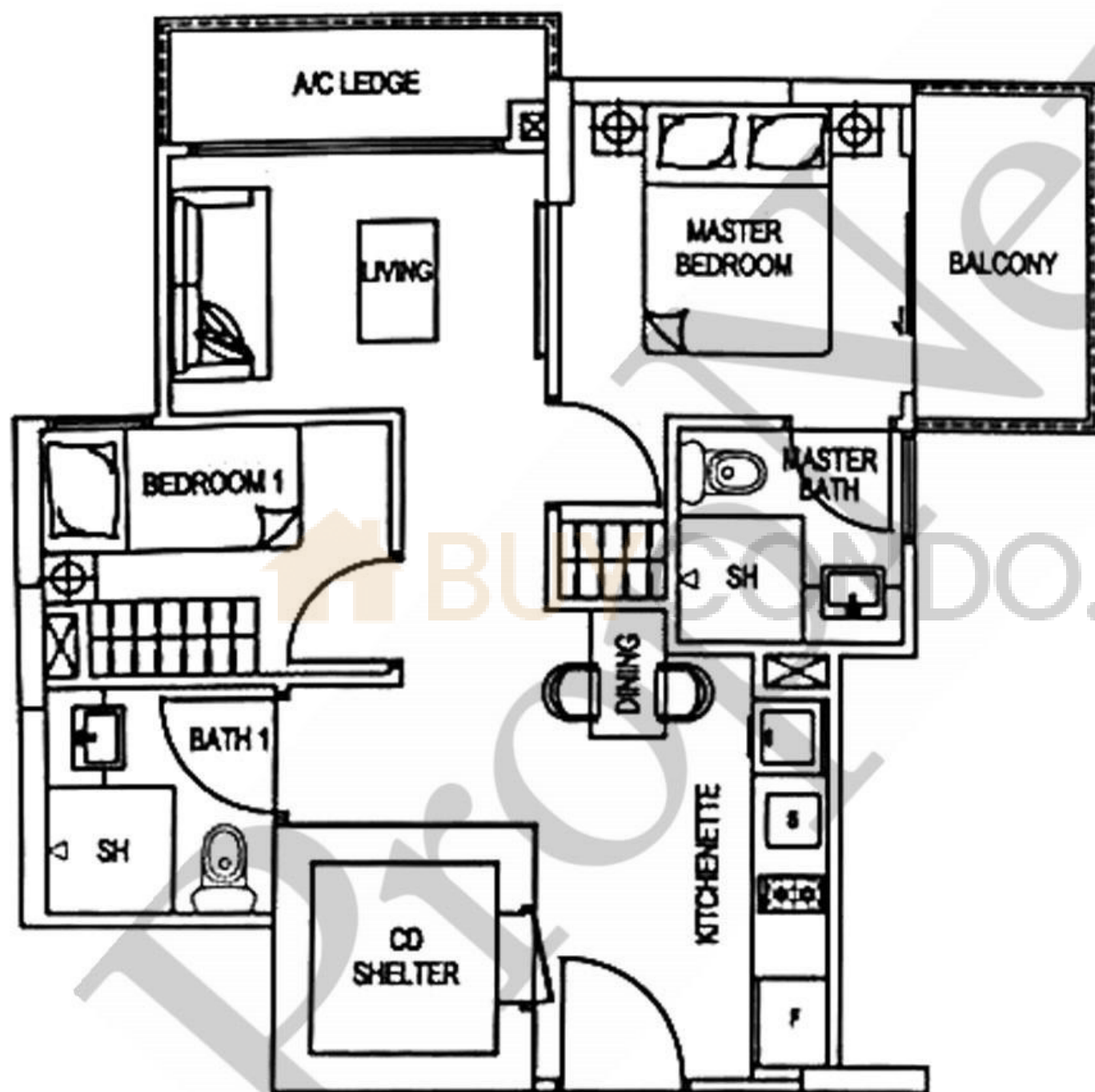

TYPE A11

Unit #02-05, #03-05, #04-05

Area 51 sqm / 549 sqft

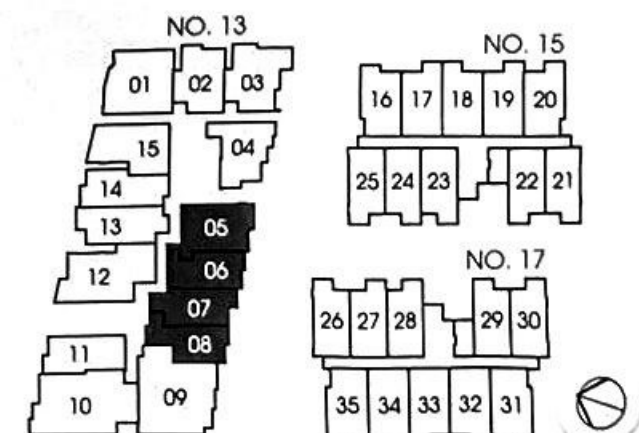
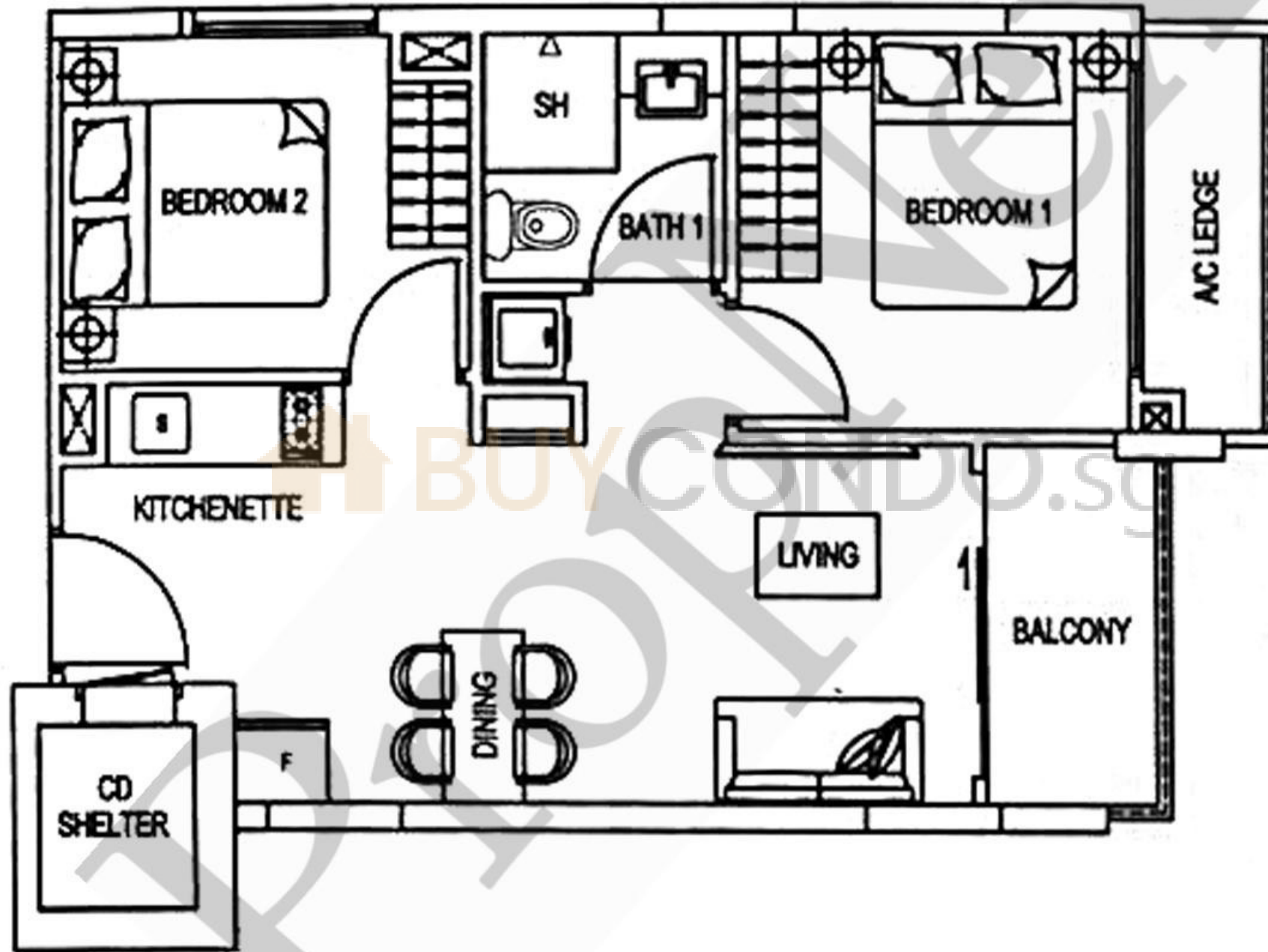

TYPE A12

Unit #02-06, #03-06, #04-06

Area 41 sqm / 441 sqft

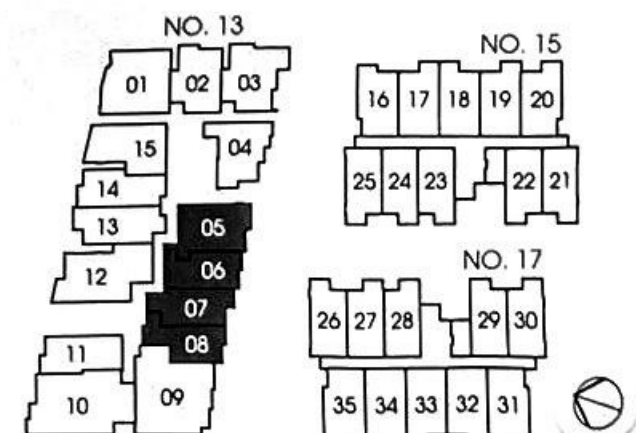
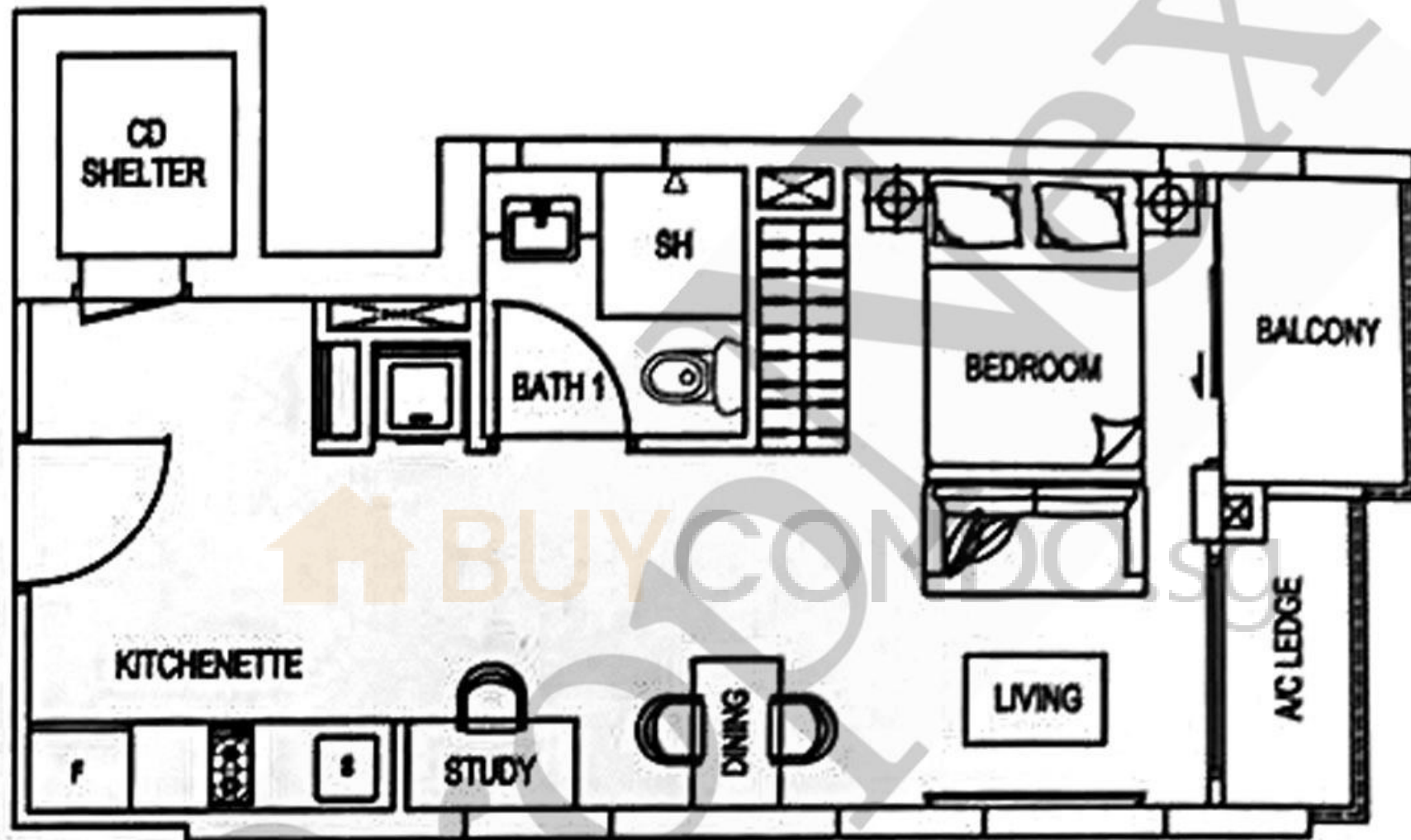

TYPE A13

Unit #02-07, #03-07, #04-07

Area 42 sqm / 452 sqft

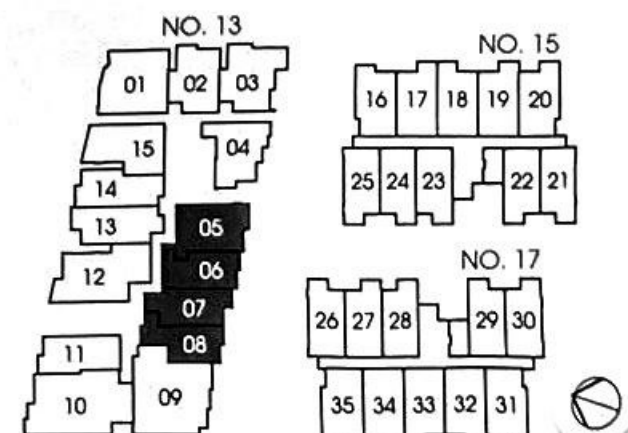
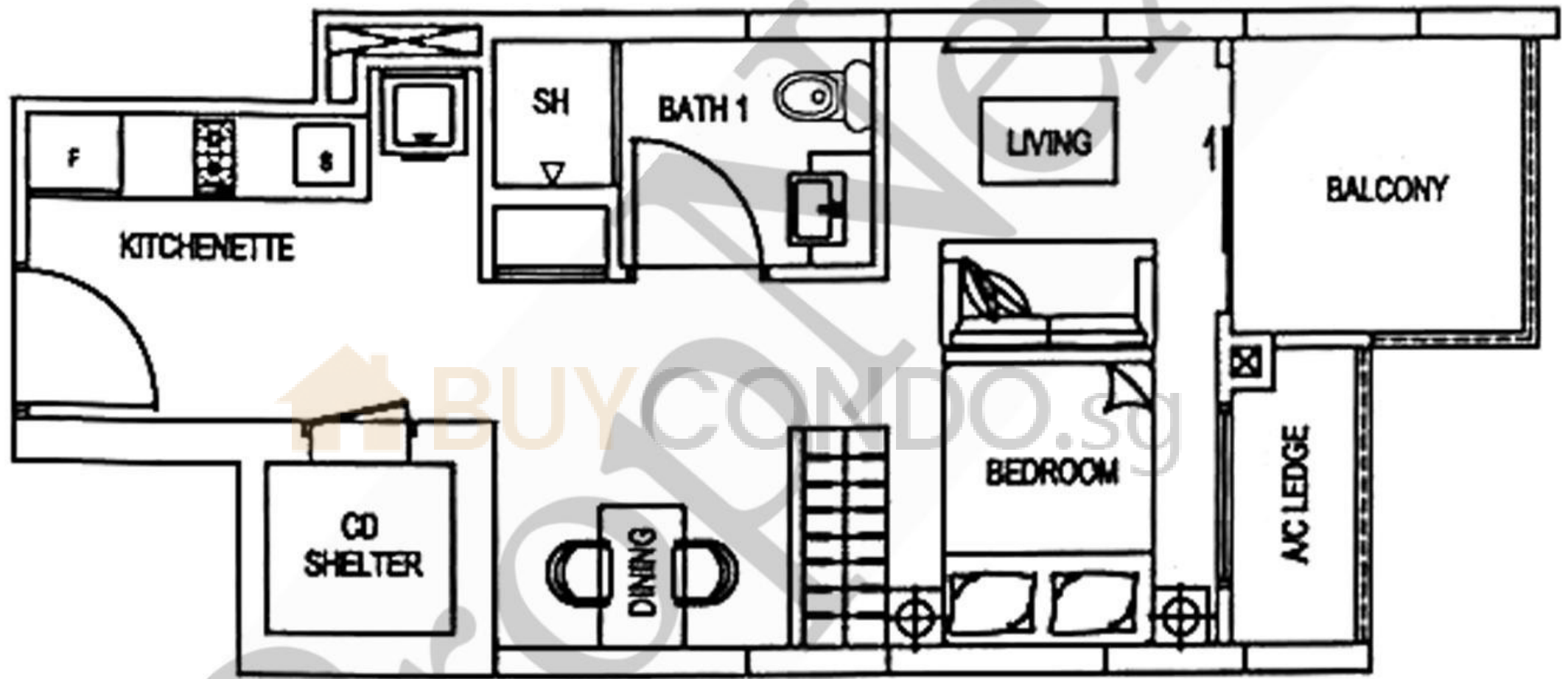

TYPE A14

Unit #02-08, #03-08, #04-08

Area 40 sqm / 431 sqft

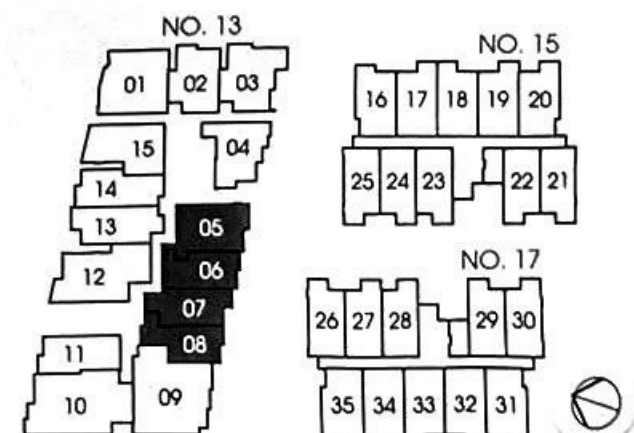
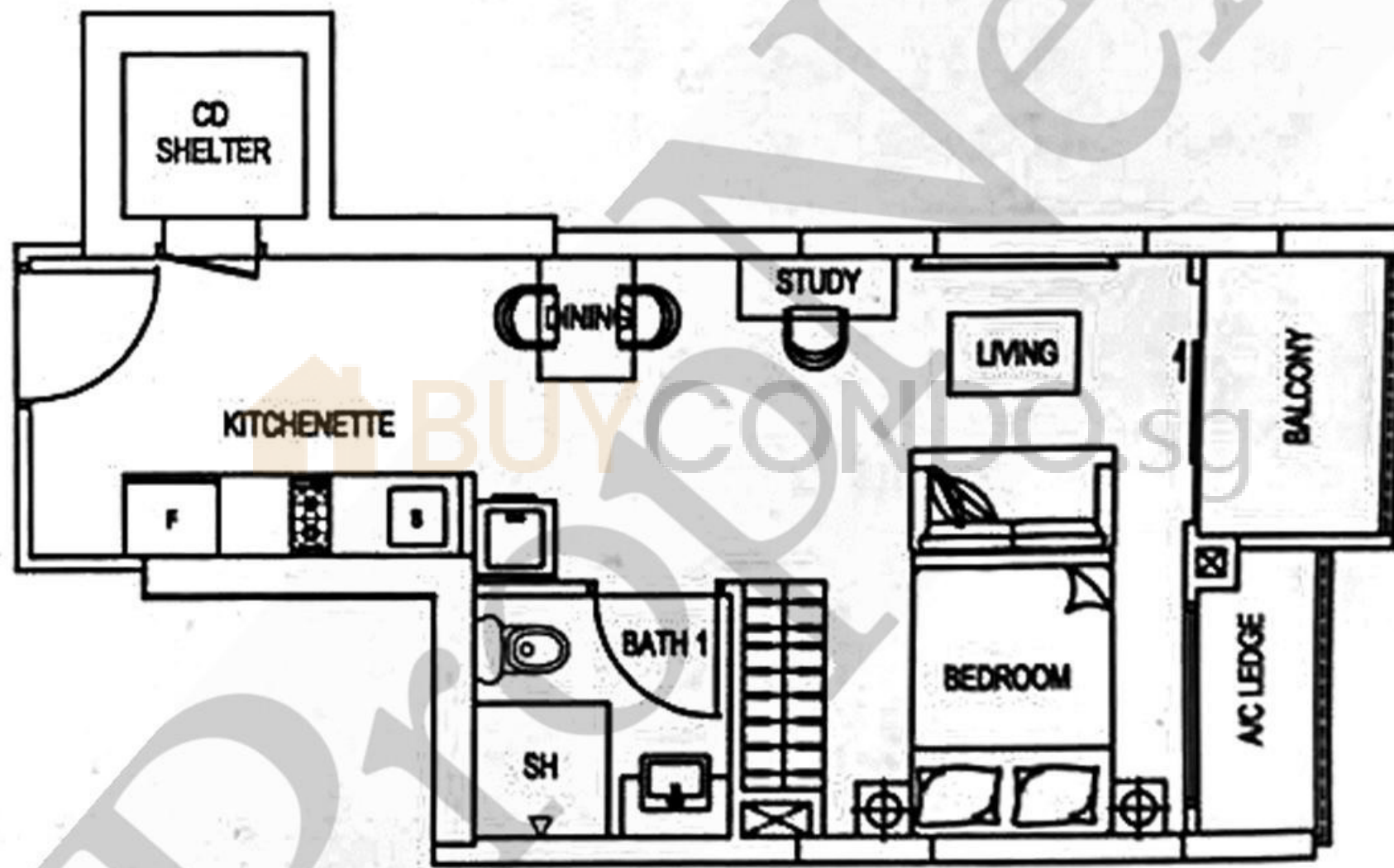

TYPE A15

Unit #02-09, #03-09, #04-09

Area 88 sqm / 947 sqft

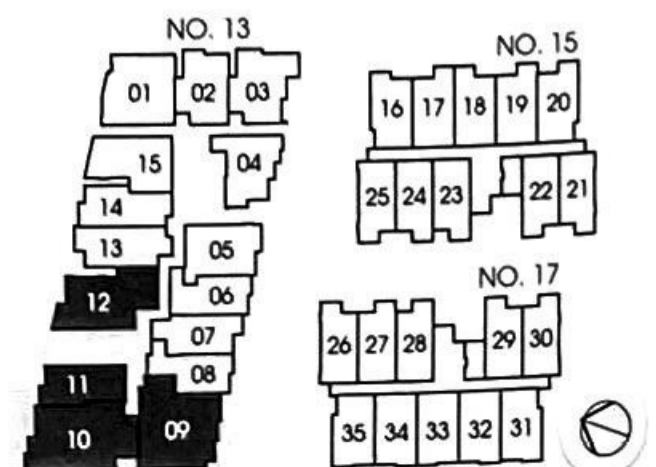
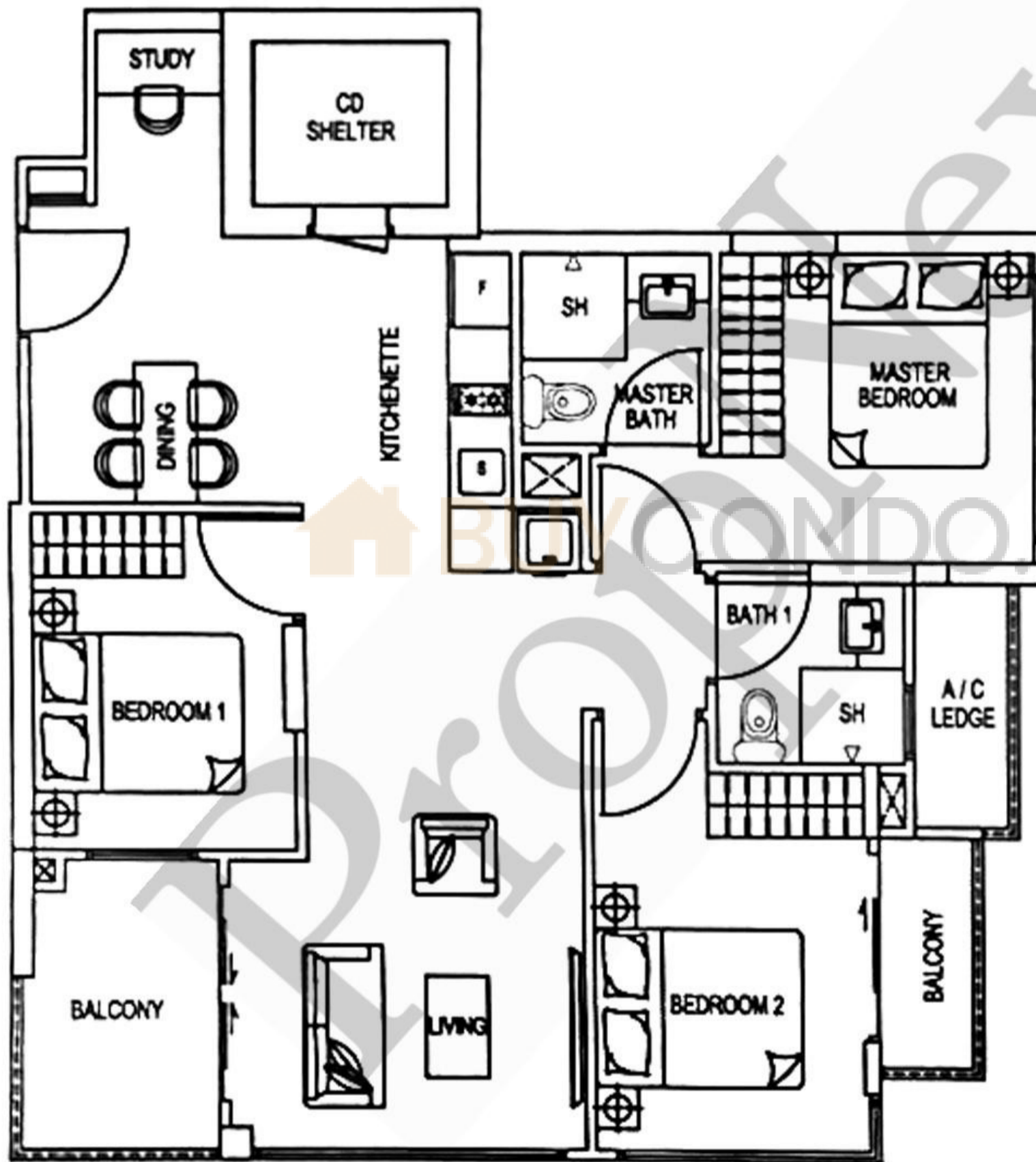

TYPE B1

Unit #02-35, #03-35, #04-35

Area 39 sqm / 420 sqft

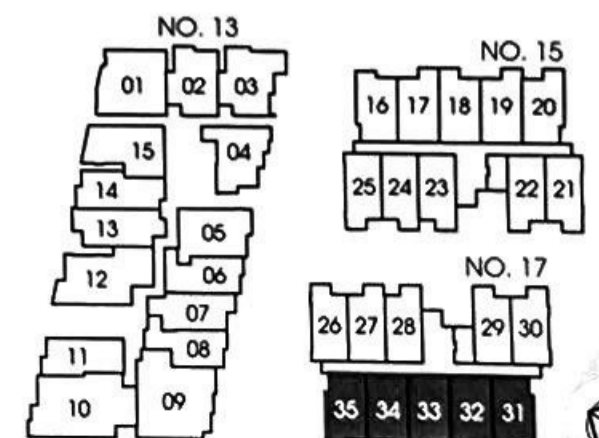
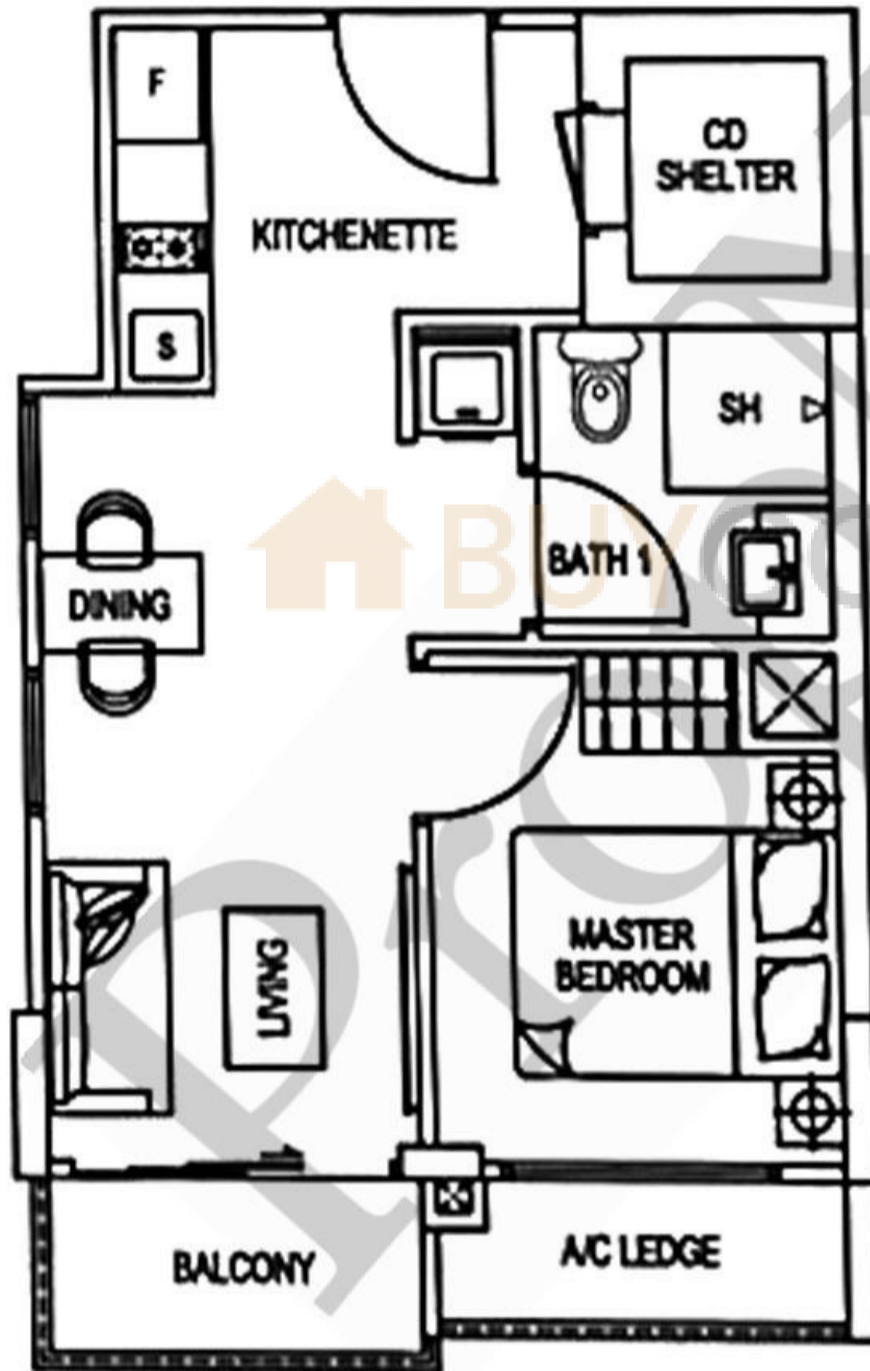

TYPE B2

Unit #02-32, #03-32, #04-32, #05-32,
#02-34, #03-34, #04-34, #05-34
Area 41 sqm / 441 sqft

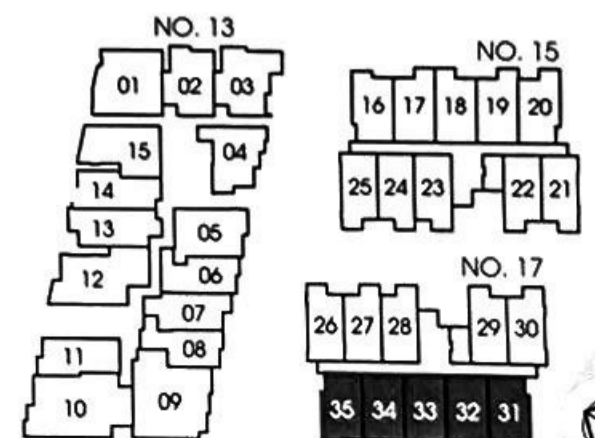
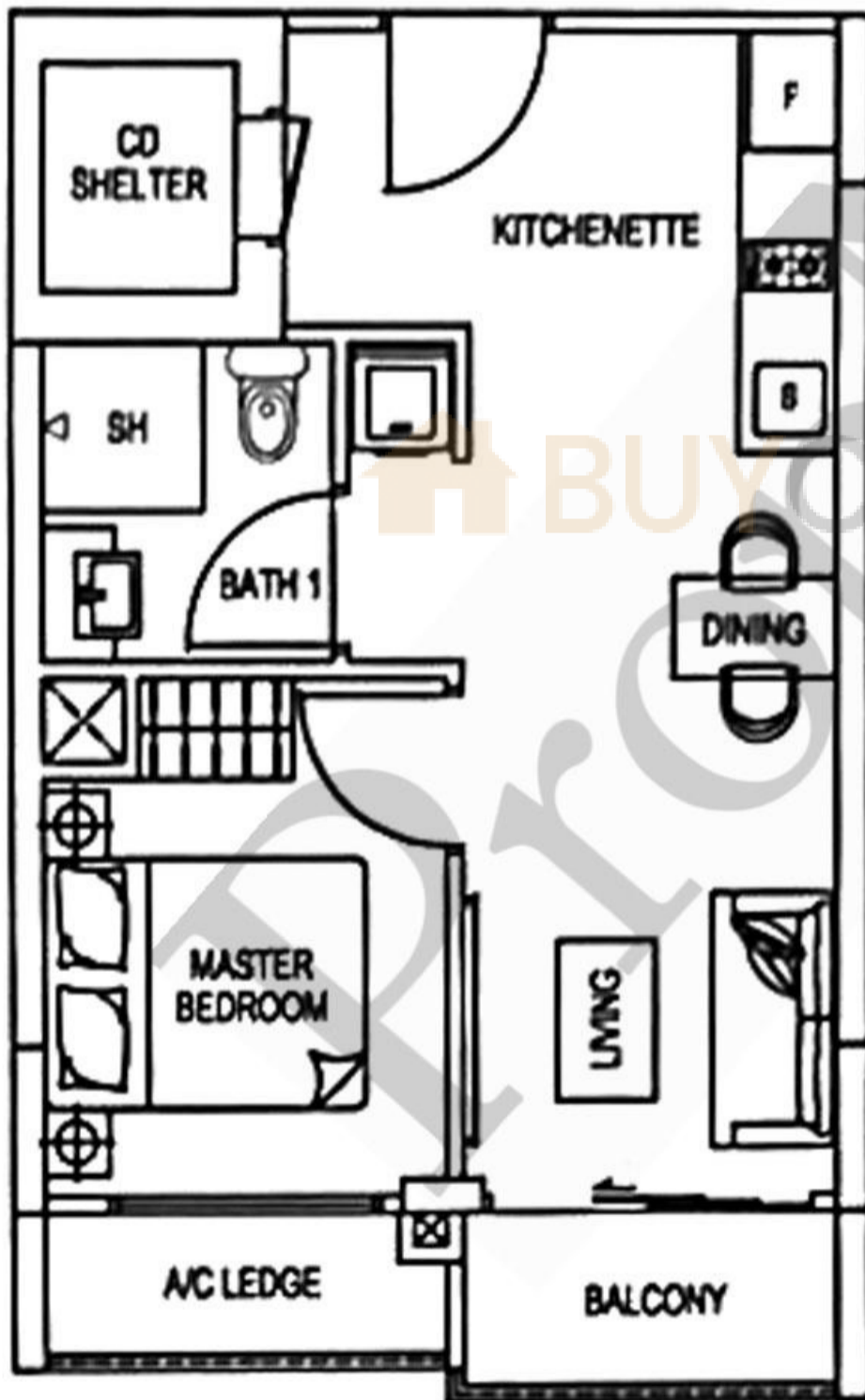

TYPE B3

Unit #02-33, #03-33, #04-33

Area 41 sqm / 441 sqft

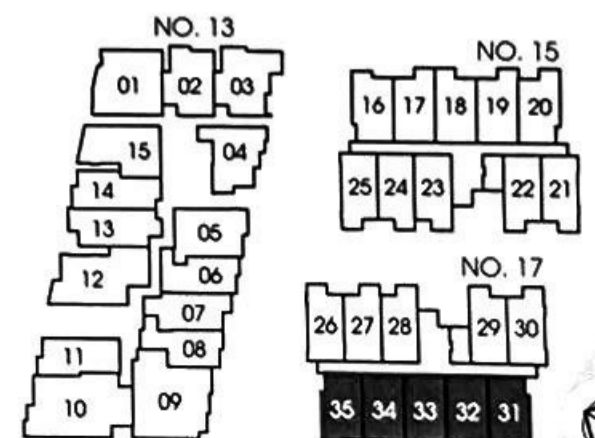
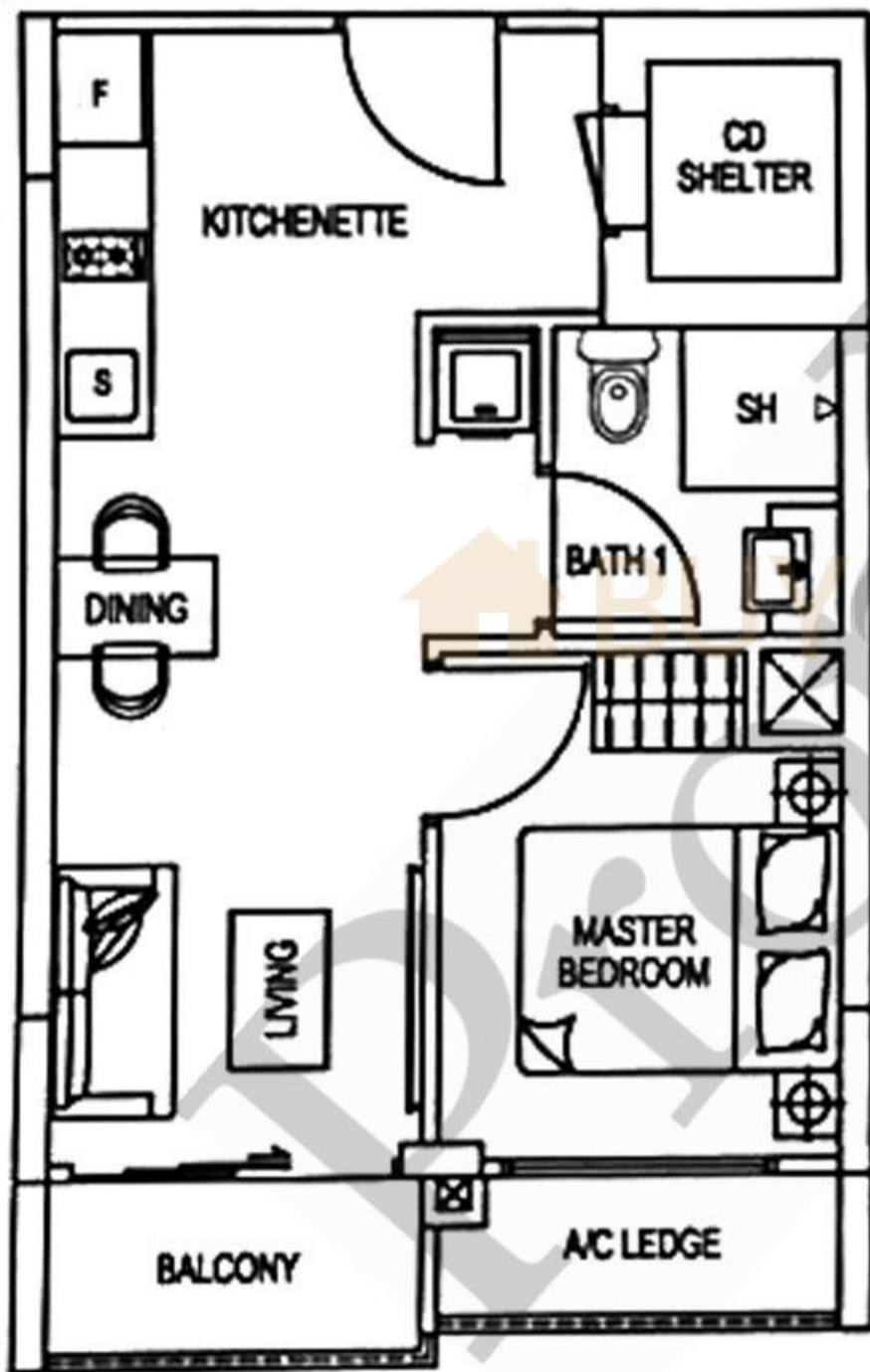

TYPE B4

Unit #02-31, #03-31, #04-31

Area 39 sqm / 420 sqft

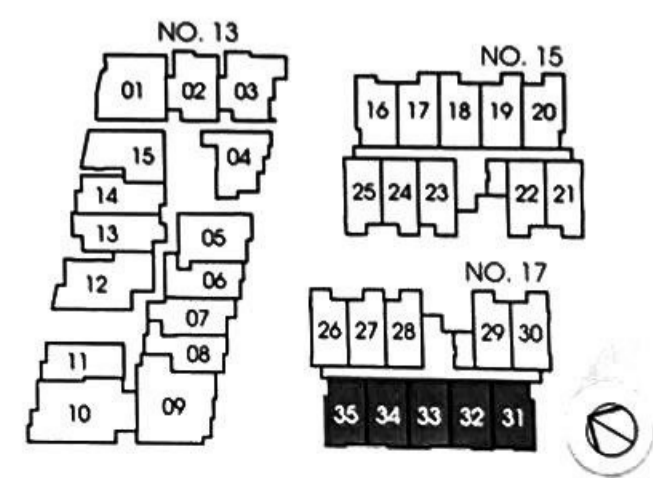
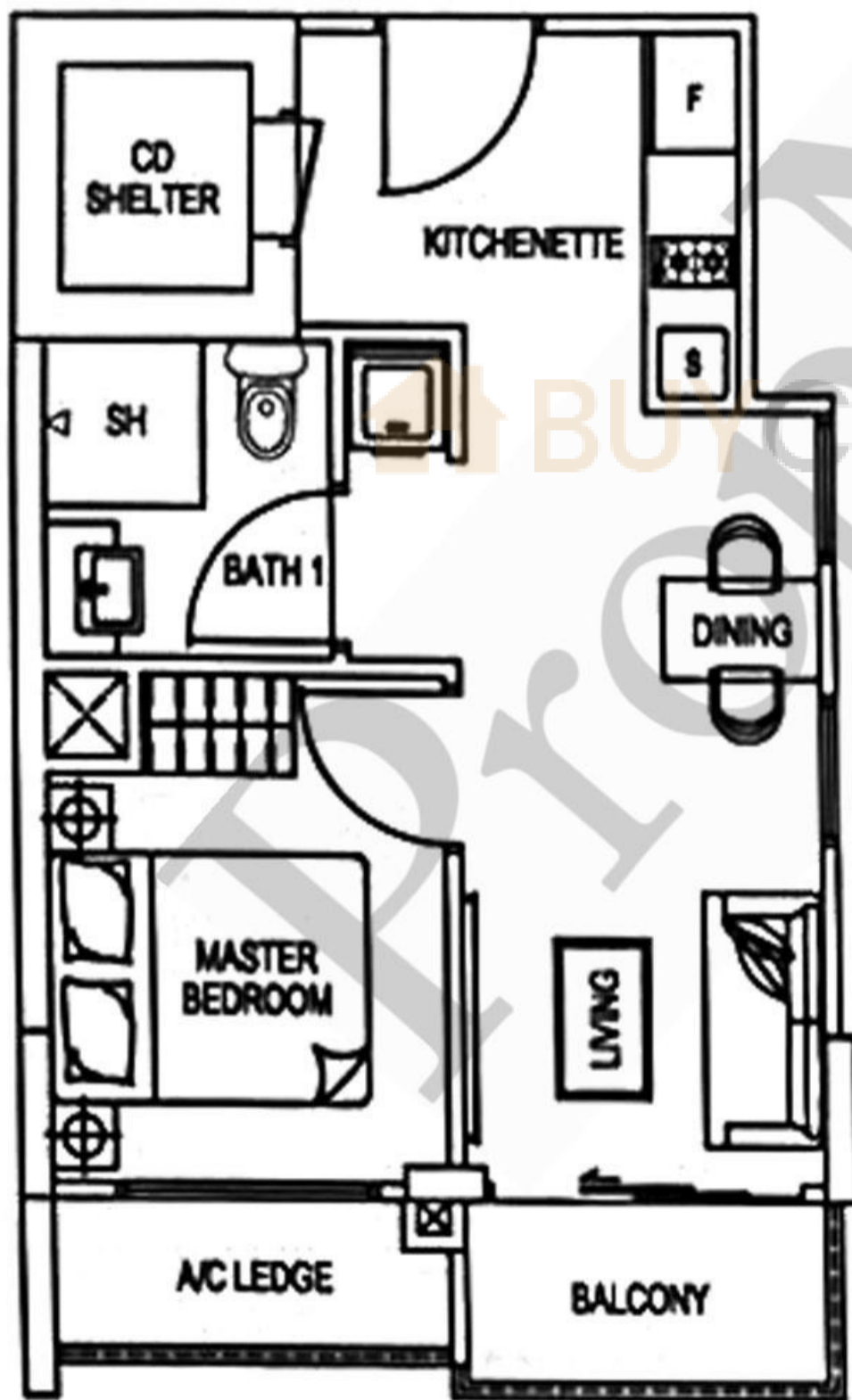

TYPE B5

Unit #02-30, #03-30, #04-30, #05-30

Area 37 sqm / 398 sqft

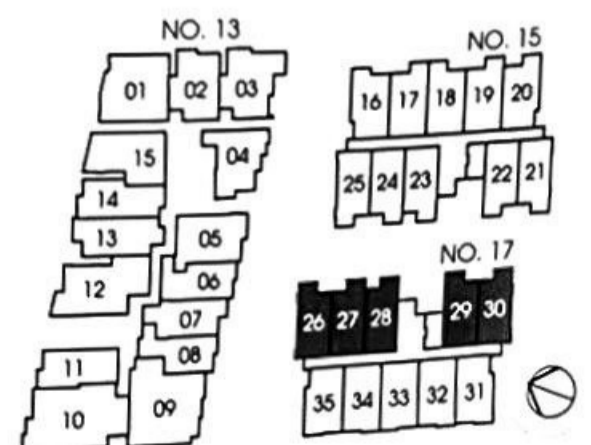

TYPE B6

Unit #02-29, #03-29, #04-29

Area 38 sqm / 409 sqft

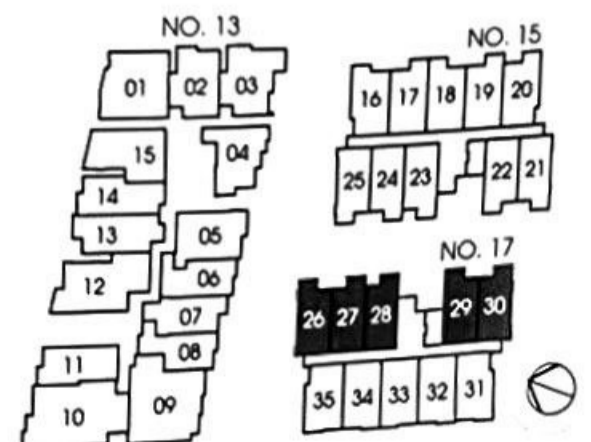

TYPE B7

Unit #02-27, #03-27, #04-27, #05-27
#02-28, #03-28, #04-28
Area 38 sqm / 409 sqft

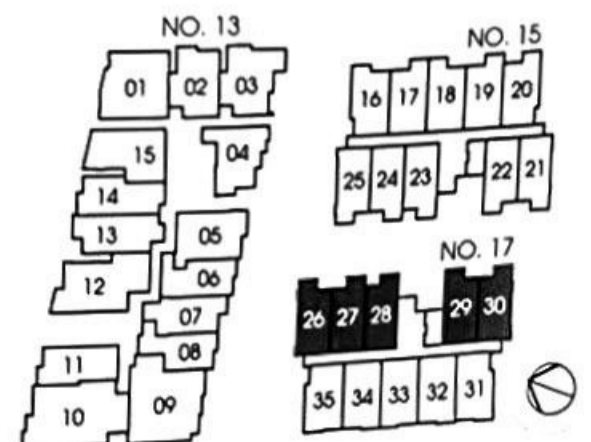

TYPE B8

Unit #02-26, #03-26, #04-26, #05-26
Area 37 sqm / 398 sqft

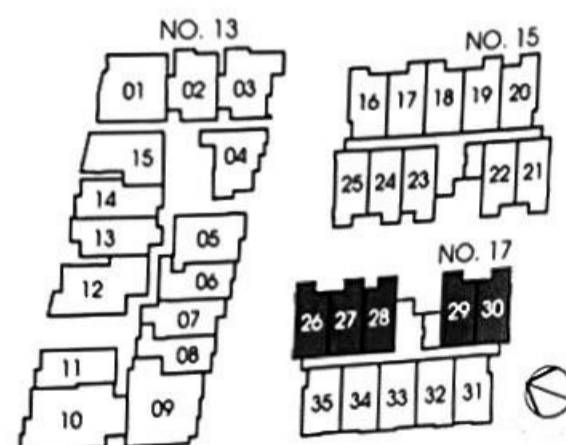

TYPE C1

Unit #02-20, #03-20, #04-20

Area 42 sqm / 452 sqft

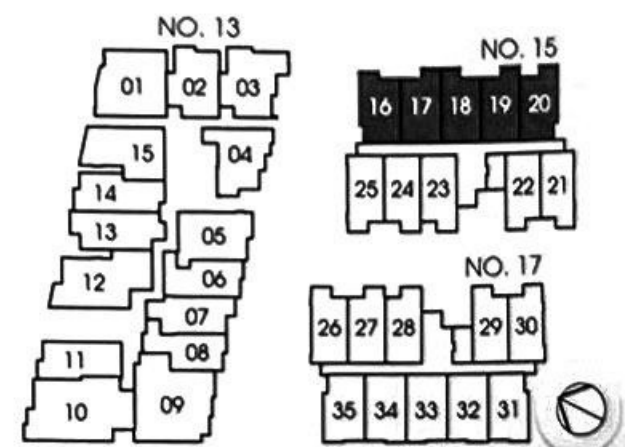
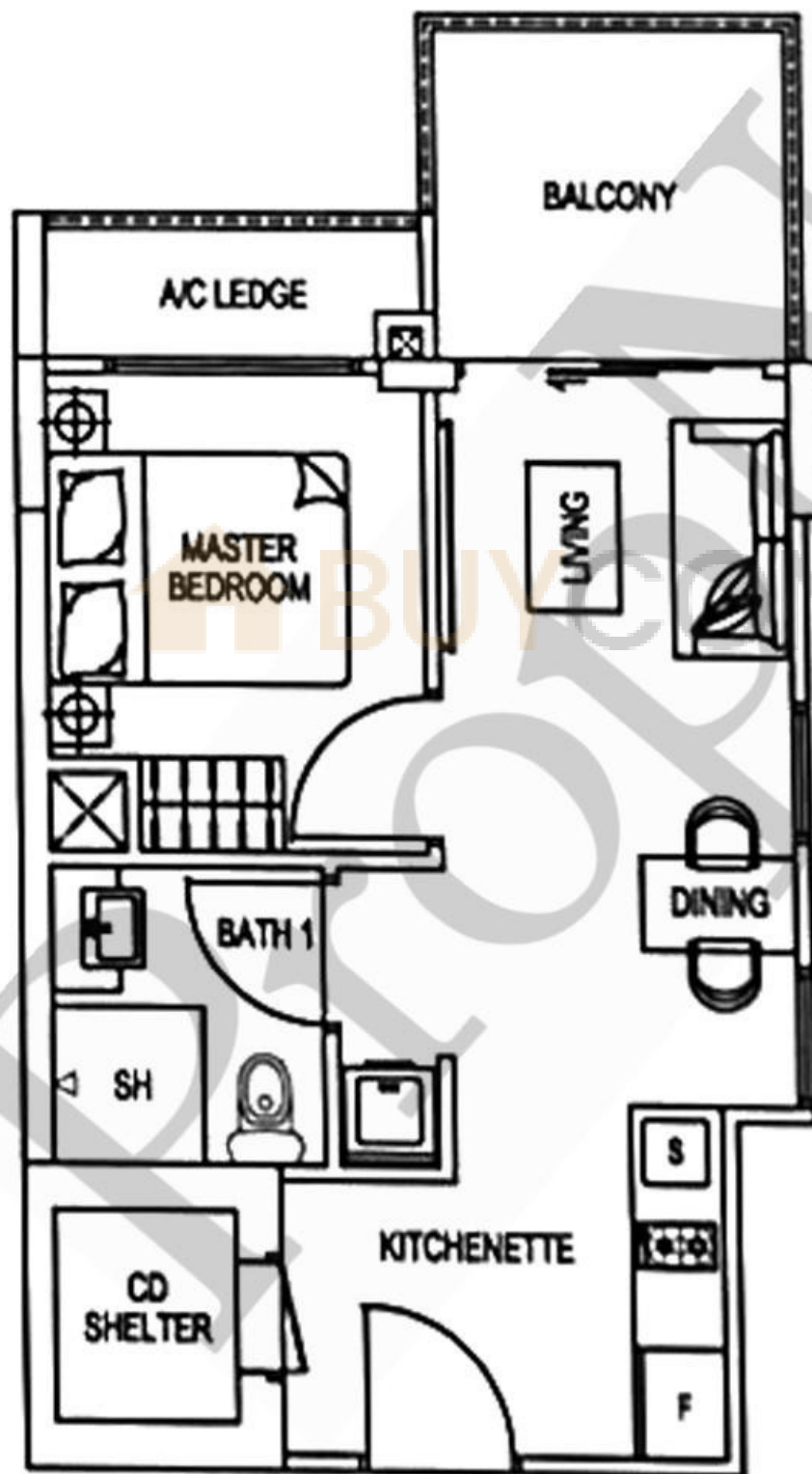

TYPE C2

Unit #02-17, #03-17, #04-17, #05-17,
#02-19, #03-19, #04-19, #05-19

Area 44 sqm / 474 sqft

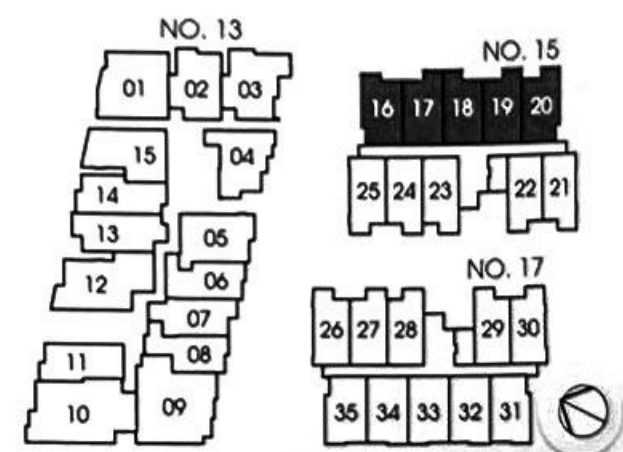
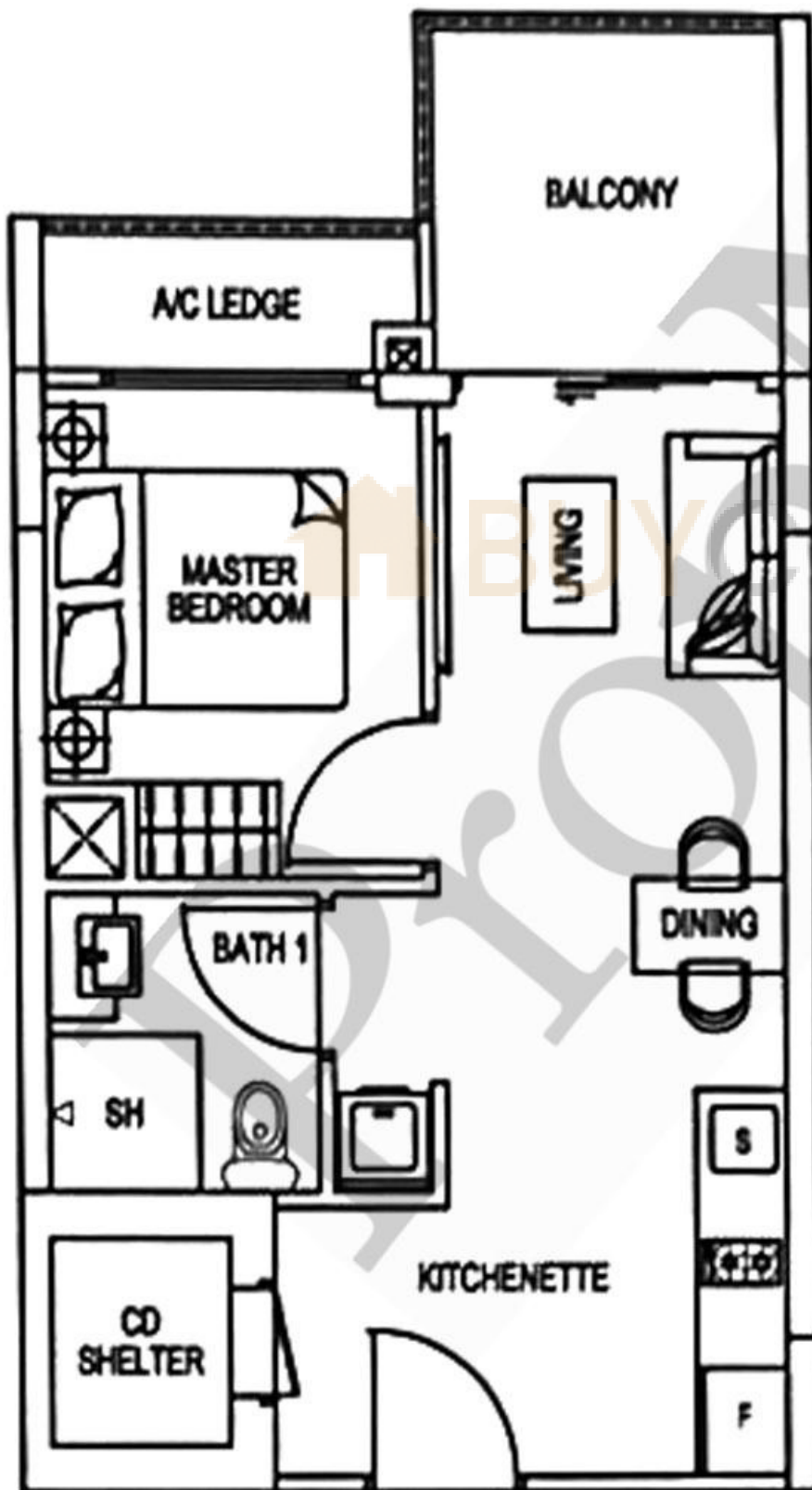

TYPE C3

Unit #02-18, #03-18, #04-18

Area 44 sqm / 474 sqft

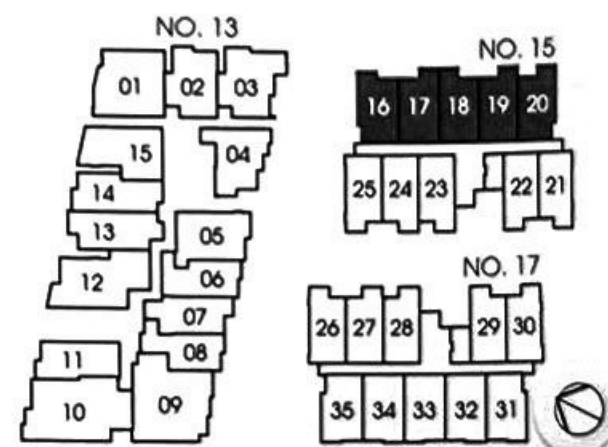
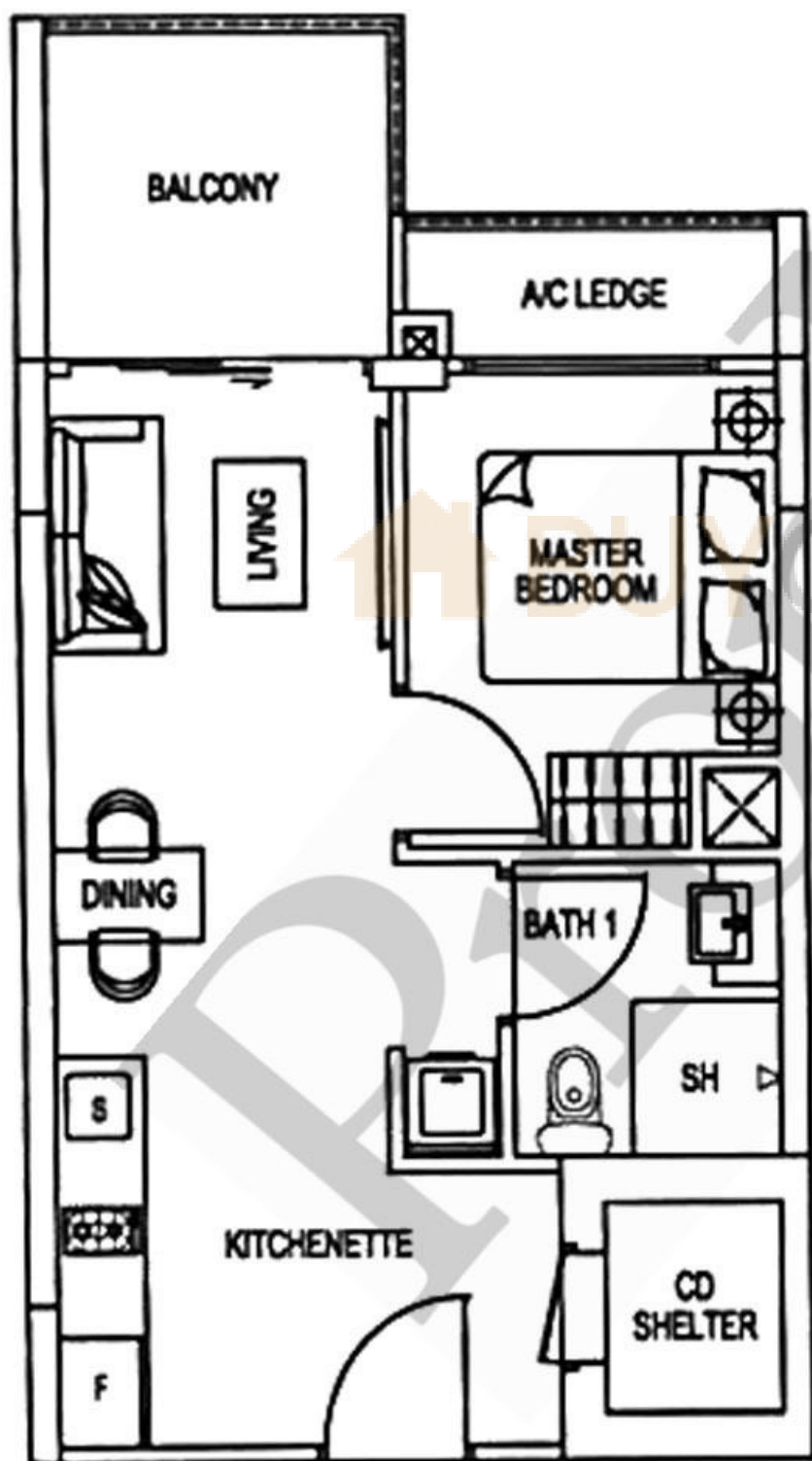

TYPE C4

Unit #02-16, #03-16, #04-16
Area 41 sqm / 441sqft

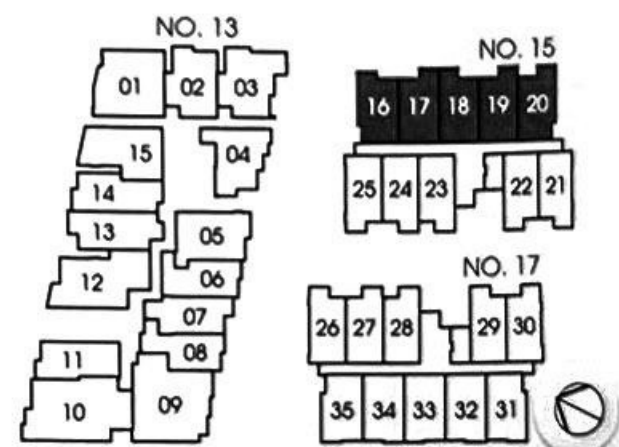

TYPE C5

Unit #02-25, #03-25, #04-25, #05-25

Area 37 sqm / 398 sqft

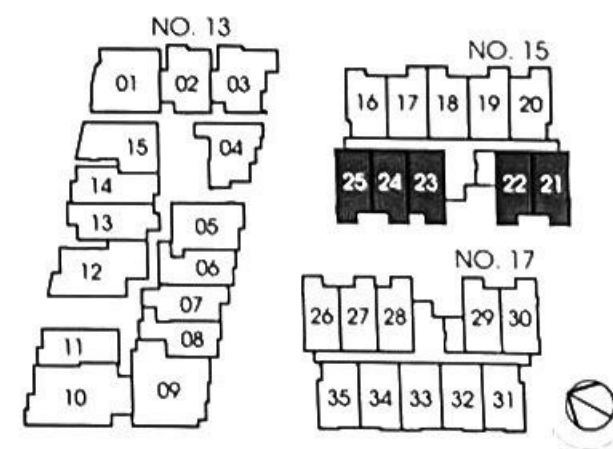
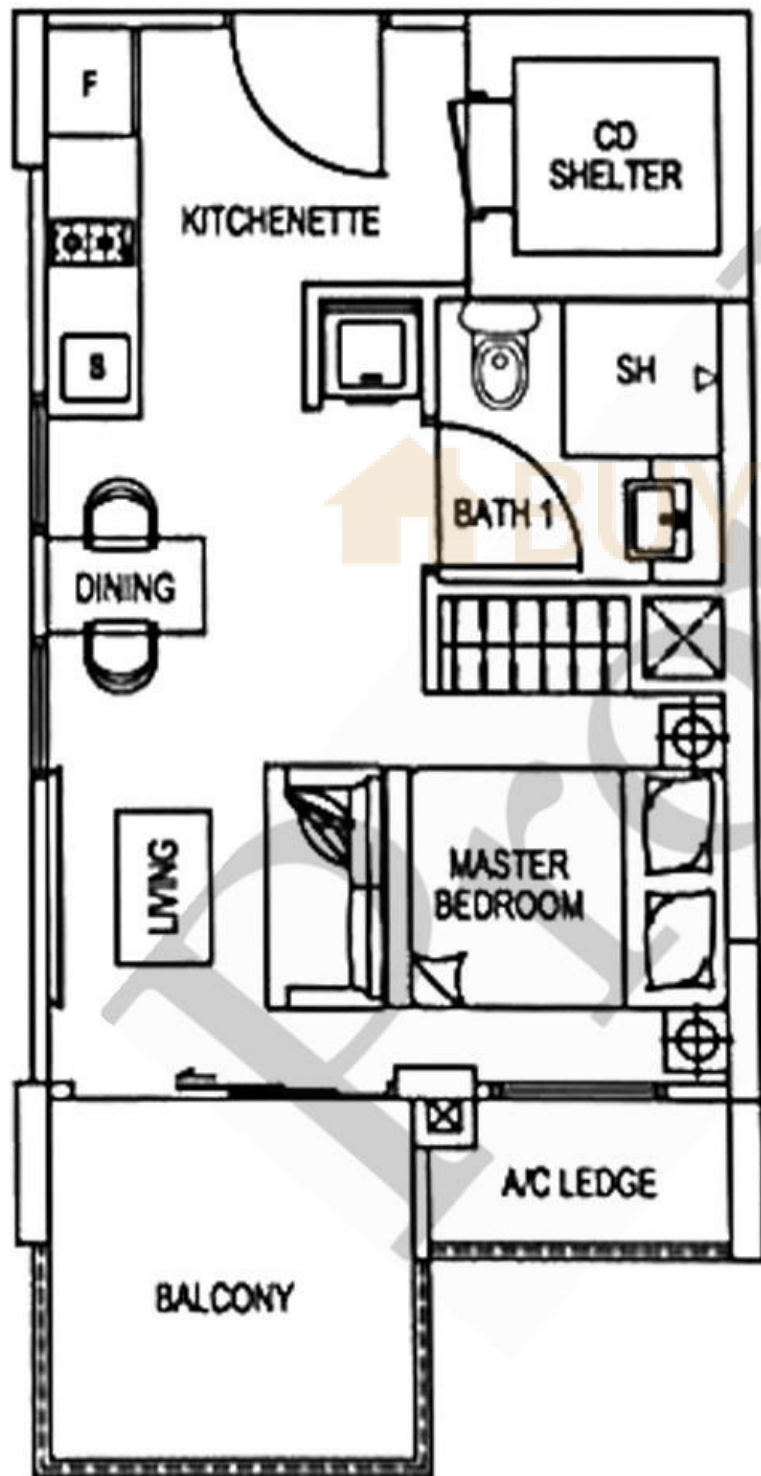

TYPE C6

Unit #02-23, #03-23, #04-23,
#02-24, #03-24, #04-24, #05-24

Area 38 sqm / 409 sqft

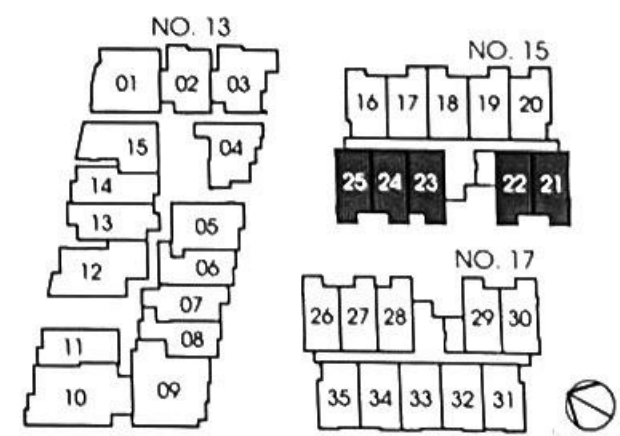
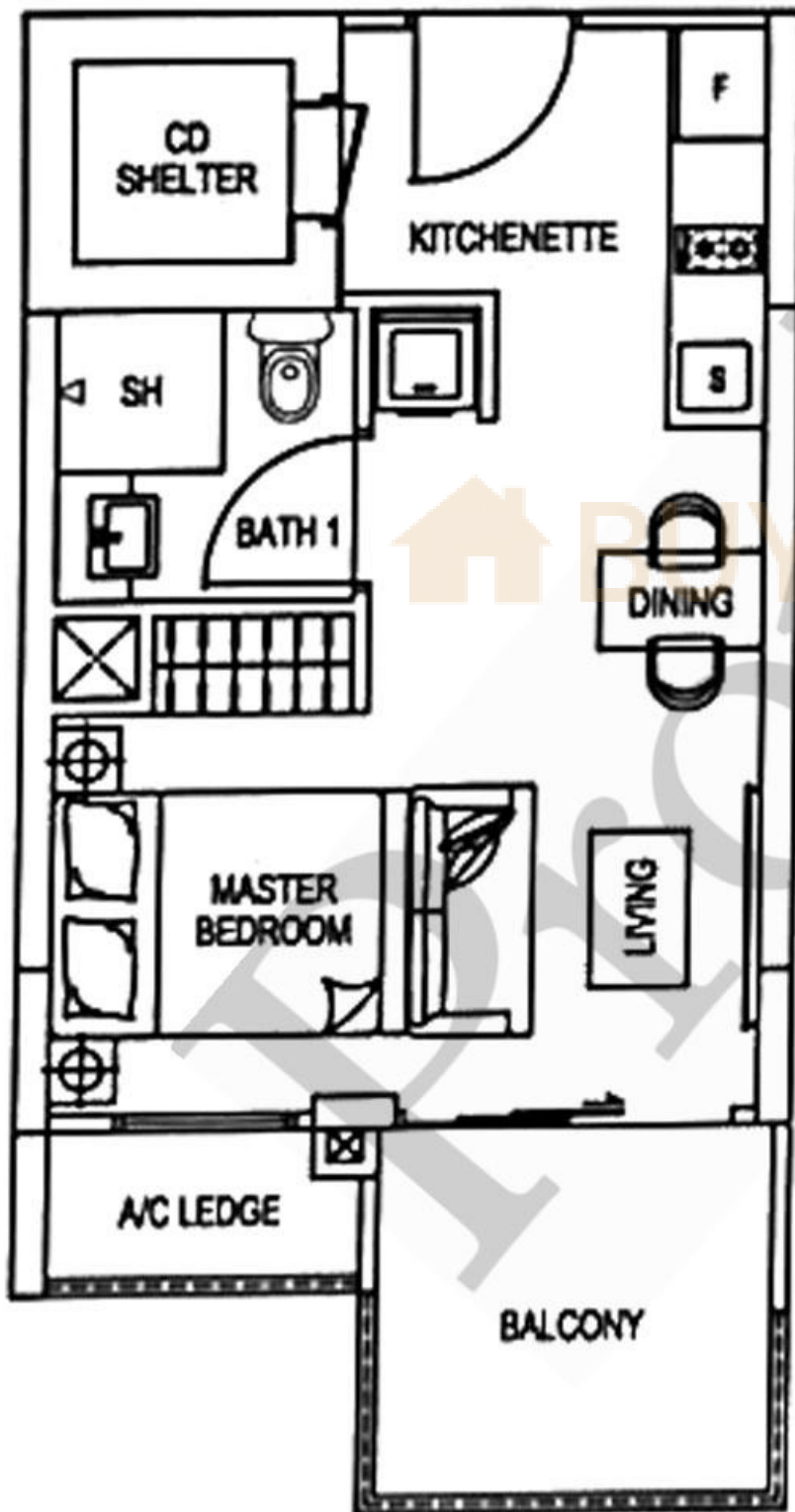

TYPE C7

Unit #02-22, #03-22, #04-22

Area 38 sqm / 409 sqft

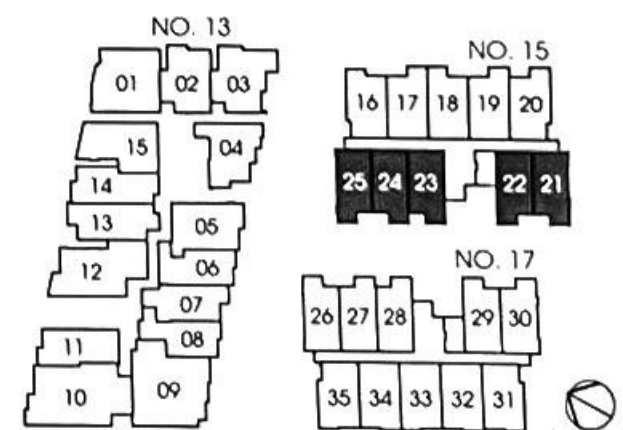
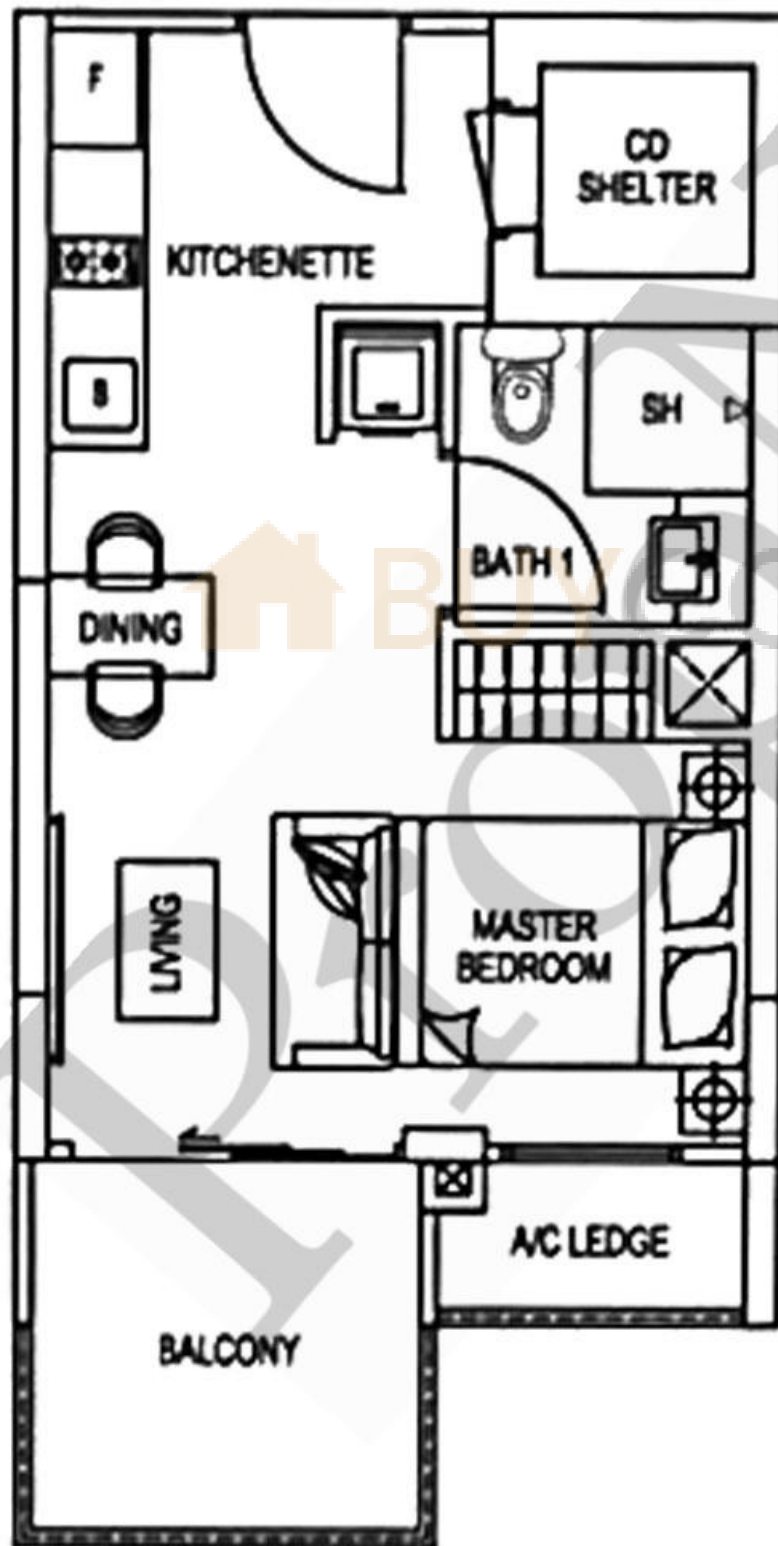

TYPE C8

Unit #02-21, #03-21, #04-21, #05-21

Area 37 sqm / 398 sqft

